

A revolutionary MLCD  
Infinitely Expandable MLCD

A revolutionary MLCD  
Infinitely Expandable **MLCD**

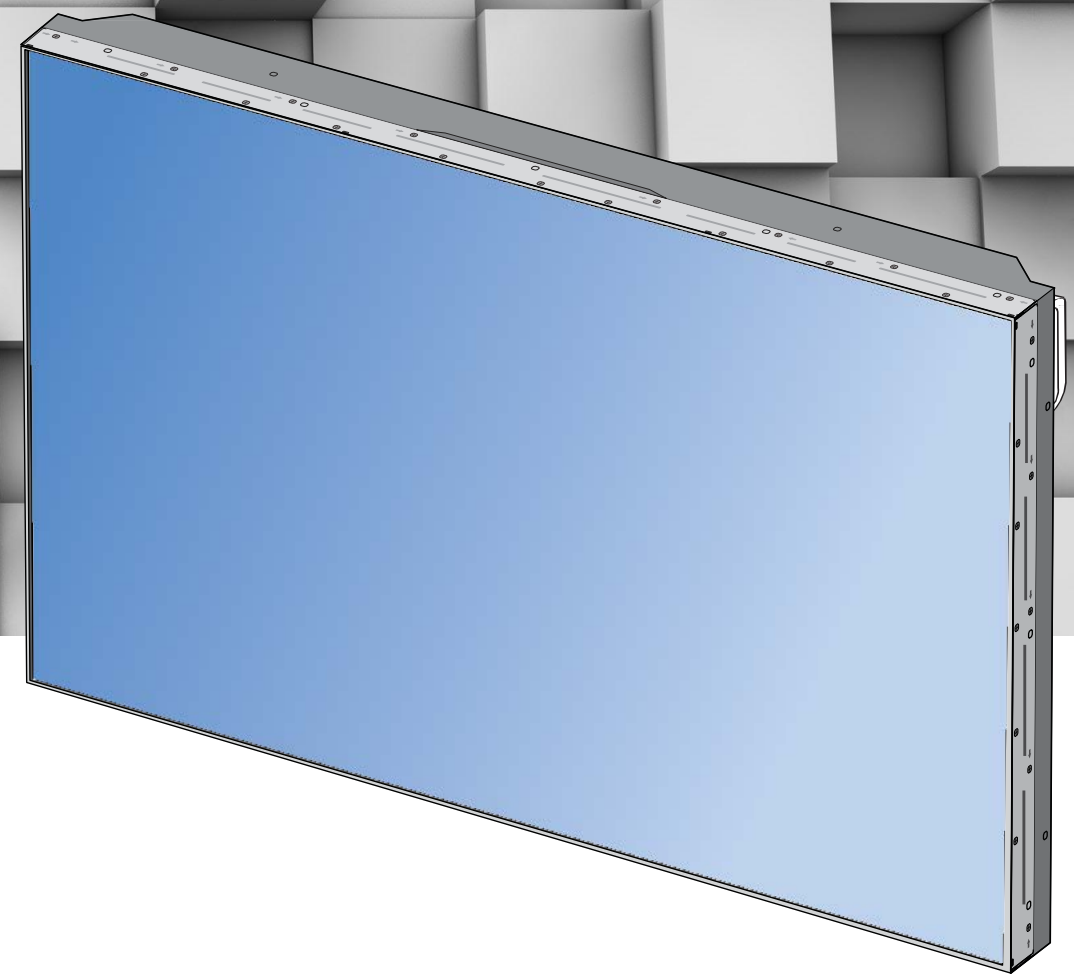

**ORION CO.,LTD.**

[www.oriondisplay.net](http://www.oriondisplay.net)

---

Address: 217, 1gongdan-ro, Gumi-si, Gyeongsangbuk-do, Korea  
Tel : +82-2-6678-8533, Fax: +82-2-6678-8599

**OLMU-K4650|OLMU-K4670|OLMU-K5550|OLMU-K5570**

**User's Manual**

---

please read through this user's manual for safety before installing this product

### Features

- ▶ Enjoy a wide flat screen with high brightness and high quality.
- ▶ Easy to install and move due to its thin design
- ▶ Enjoy your favorite programs with various split-screen features simultaneously presenting several programs.

### Thank you for purchasing our monitor.

This manual describes how to use the product and notes in use.  
Please read the manual carefully before using it.  
After reading this manual, please retain for future reference.

If you have any questions or a problem occurs, please contact either the company you purchased this product from or an authorized service center.

- ※ **Displaying static picture for an extended period of time may cause a burn-in effect.**
- ※ **Burn-in effect and the faults in brightness and picture elements caused by fixed images are not subject to the warranty coverage.**



#### Warning

If you fail to comply with the regulations for safety and proper use, fire or injury may be caused.



#### Warning

To prevent electric shock, Do not remove cover.  
No user serviceable part inside.  
Refer servicing to qualified service personnel.

### Supplied Accessories

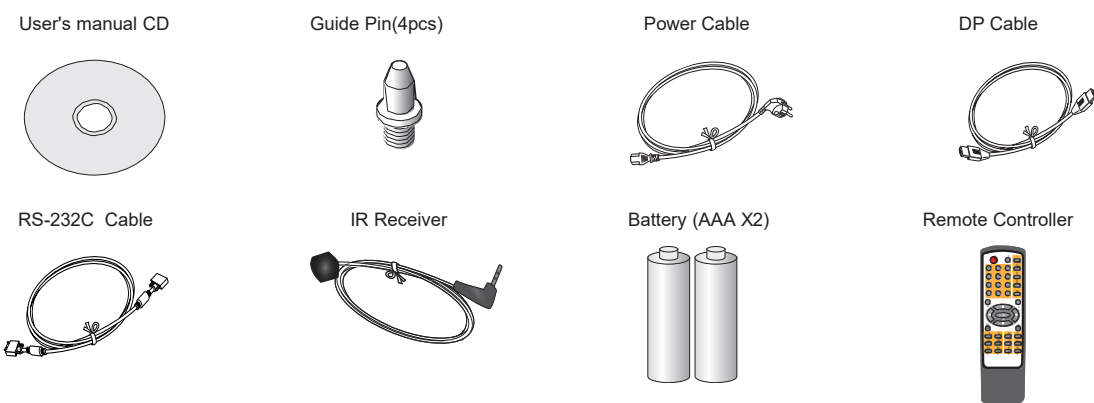

### Optional Accessories



#### Class A digital device

#### Notice to users

It is a device designed for business purpose with a safety certificate for electromagnetic interference, which user should be mindful of.



### " Important Safety Instructions"

- 1) Read these instructions.
- 2) Keep these instructions.
- 3) Heed all warnings.
- 4) Follow all instructions.
- 5) Do not use this apparatus near water.
- 6) Clean only with dry cloth.
- 7) Do not block any ventilation openings. Install in accordance with the manufacturer's instructions.
- 8) Do not install near any heat sources such as radiators, heat registers, stoves, or other apparatus (including amplifiers) that produce heat.
- 9) Do not defeat the safety purpose of the polarized or grounding-type plug. A polarized plug has two blades with one wider than the other. A grounding type plug has two blades and a third grounding prong. The wide blade or the third prong are provided for your safety. If the provided plug does not fit into your outlet, consult an electrician for replacement of the obsolete outlet.
- 10) Protect the power cord from being walked on or pinched particularly at plugs, convenience receptacles, and the point where they exit from the apparatus.
- 11) Only use attachments/accessories specified by the manufacturer.
- 12) Use only with the cart, stand, tripod, bracket, or table specified by the manufacturer, or sold with the apparatus. When a cart is used, use caution when moving the cart/apparatus combination to avoid injury from tip-over. 
- 13) Unplug this apparatus during lightning storms or when unused for long periods of time.
- 14) Refer all servicing to qualified service personnel. Servicing is required when the apparatus has been damaged in any way, such as power-supply cord or plug is damaged, liquid has been spilled or objects have fallen into the apparatus, the apparatus has been exposed to rain or moisture, does not operate normally, or has been dropped.  
The symbol in figure 21 shall be shown adjacent to the text of item 12 above.

#### FCC Verified : Class "A"

This device complies with the Part 15 of the FCC Rules. Operation is subject to the following two conditions :

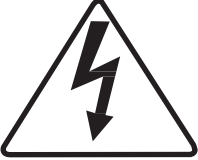
- 1) This device may not cause harmful interference, and
- 2) This device must accept any interference received, including interference that may cause undesired operation.

	<b>CAUTION</b> RISK OF ELECTRIC SHOCK DO NOT OPEN	
<p>CAUTION : TO REDUCE THE RISK OF ELECTRIC SHOCK, DO NOT REMOVE COVER (OR BACK). NO USER-SERVICEABLE PARTS INSIDE. REFER SERVICING TO QUALIFIED SERVICE PERSONNEL.</p>		



This symbol is intended to alert the user to the presence of uninsulated "dangerous voltage" within the product's enclosure that may be of sufficient magnitude to constitute a risk of electric shock to persons.



This symbol is intended to alert the user to the presence of important operating and maintenance(servicing) instructions in the literature accompanying the appliance.

## NOTICE

1. To disconnect the apparatus from the mains, the plug must be pulled out from the mains socket, therefore the mains plug shall be readily operable
2. WARNING - To Reduce The Risk Of Fire Or Electric Shock, Do Not Expose This Appliance To Rain Or Moisture.
3. Apparatus shall not be exposed to dripping or splashing and no objects filled with liquids, such as vases, shall be placed on the apparatus.
4. Use only a properly grounded plug and receptacle
5. "Warning" CAUTION – These servicing instructions are for use by qualified service personnel only. To reduce the risk of electric shock, do not perform any servicing other than that contained in the operating instructions unless you are qualified to do so.

## Contents

※ European Union Disposal Information .....	4
※ Cautions for consisting .....	5
※ Clearance for Ventilation .....	6
※ Cleaning and Maintenance.....	7
※ Please keep following instruction for panel protection without exception.....	8
※ Handle with Caution .....	9
※ How to carry.....	10
※ Application information .....	11
※ Attention for Installing .....	12
<b>1. Safety Precautions.....</b>	<b>14</b>
<b>2. Names.....</b>	<b>16</b>
<b>3. How to Connect Cables.....</b>	<b>18</b>
3.1. Connection of Single.....	18
3.2. Connection of Multiple (for DP in).....	20
3.3. Connection of Multiple (for HDMI in).....	21
3.4. Connection of Multiple (for DVI in).....	22
3.5. Connection of Control Cable.....	23
<b>4. ID Setting.....</b>	<b>26</b>
4.1. Sequential Connection.....	26
4.2. Random Connection.....	28
<b>5. OSD Menu.....</b>	<b>32</b>
5.1. Picture Menu.....	32
5.2. Input Menu.....	33
5.3. Schedule Menu.....	34
5.4. Multi-Display Menu.....	35
5.5. Other Menu.....	36
5.6. Information Menu.....	37
<b>6. Setting and operation of OSW.....</b>	<b>38</b>
6.1. Installation.....	38
6.2. Start OSW.....	39
6.3. Communication Configuration.....	42
6.4. Screen Configuration.....	49
6.5. Explanation of the command transmission method.....	50
6.6. Basic Control.....	50
6.7. Control.....	55
<b>7. PROTOCOL.....</b>	<b>66</b>
7.1. Communication Setting.....	66
7.2. Protocol Format.....	67
7.3. Command.....	68
<b>8. Before calling for service.....</b>	<b>72</b>
<b>9. Applicable signals.....</b>	<b>73</b>
<b>10. Specification.....</b>	<b>74</b>
<b>11. Regulatory Information.....</b>	<b>75</b>
<b>12. Dimension.....</b>	<b>76</b>
12.1. OLMU-K4650/OLMU-K4670.....	76
12.2. OLMU-K5550/OLMU-K5570.....	77

## ※ European Union Disposal Information

## ※ Cautions for consisting

WARNING

WARNING

English

**Disposal of old Electrical & Electronic Equipment (Applicable throughout the European Union and other European countries with separate collection programs)**

This symbol found on your product or on its packaging, indicates that this product should not be treated as household waste when you wish to dispose of it. Instead, it should be handed over to an applicable collection point for the recycling of electrical and electronic equipment. By ensuring this product is disposed of correctly, you will help prevent potential negative consequences to the environment and human health, which could otherwise be caused by inappropriate disposal of this product. The recycling of materials will help to conserve natural resources.



This symbol is only valid in the European Union. If you wish to discard this product, please contact your local authorities or dealer and ask for the correct method of disposal.

Español

**Deshecho de equipos eléctricos y electrónicos (aplicable a la Unión Europea y a otros países europeos con programas de reciclaje independientes)**

La presencia de este símbolo en el propio producto o en su material de embalaje, indica que no se debe tratar como residuo doméstico cuando desee deshacerse de él. En su lugar, debe entregarlo en el punto limpio correspondiente de reciclaje de equipos eléctricos y electrónicos. Asegurándose de que este producto se desecha de forma correcta, ayudará a evitar posibles consecuencias negativas para la conservación del medioambiente y la salud humana, consecuencias que podrían darse si se desecha del producto de forma inadecuada. El reciclado de materiales ayuda a conservar los recursos naturales.



Este símbolo solamente es válido en la Unión Europea. Si desea deshacerse de este producto, póngase en contacto con las autoridades locales o con su distribuidor y pida información sobre el método de disposición adecuado.

Português

**Eliminação de equipamentos eléctricos e electrónicos usados (aplicável na União Europeia e noutros países europeus com programas próprios de recolha destes equipamentos)**

Este símbolo, colocado no produto ou na respectiva embalagem, indica que o produto não deve ser tratado como lixo doméstico aquando da sua eliminação. Em vez disso, deve ser entregue num ponto de recolha de equipamentos eléctricos e electrónicos para posterior reciclagem. Ao garantir a correcta eliminação deste produto, estará a evitar consequências potencialmente negativas tanto para o ambiente como para a saúde humana. A reciclagem de materiais ajuda a preservar os recursos naturais.



Este símbolo apenas é válido na União Europeia. Se quiser eliminar este produto, contacte as entidades locais ou o seu fornecedor para ficar a saber qual o método de eliminação correcto.

Svenska

**Avfall av förbrukad elektrisk och elektronisk utrustning (Tillämpbart i hela Europeiska unionen och andra europeiska länder med separata samlingsprogram)**

Den här symbolen som finns på din produkt eller på dess förpackning påvisar att produkten inte ska behandlas som hushållsavfall när du vill slänga bort den. Istället ska den lämnas över till en lämplig uppsamlingspunkt för återvinning av elektriska och elektroniska utrustningar. Genom att tillförsäkra att den här produkten återvinns på ett riktigt sätt hjälper du till med att förhindra möjliga negativa konsekvenser för miljön och mänsklig hälsa. Det kan annars orsakas på grund av olämplig sophantering av den här produkten. Återvinning av material kommer att hjälpa till att bevara naturligtillgångar.



Den här symbolen är endast giltig inom den Europeiska unionen. Om du vill slänga bort den här produkten ska du kontakta lokala myndigheter eller återförsäljare, och fråga efter lämplig avfallsmetod.

Français

**Mise au rebut des équipements électriques et électroniques usagés (Valable dans l'ensemble de l'Union Européenne ainsi que dans les pays européens disposant de programmes distincts de collecte des déchets)**

Ce symbole appliqué sur votre produit ou sur son emballage indique que ce produit ne doit pas être traité comme un déchet ménager lorsque vous voulez le mettre au rebut. Il doit au contraire être remis à un site de collecte agréé pour le recyclage des équipements électriques et électroniques. En veillant à ce que ce produit soit mis au rebut de façon adéquate, vous contribuerez à prévenir les conséquences potentiellement négatives sur l'environnement et la santé humaine qui résulteraient de sa production en cas de mise au rebut inappropriée de ce produit. Le recyclage des matériaux contribue également à économiser les ressources naturelles.



Ce symbole n'est valable que dans l'Union Européenne. Si vous souhaitez mettre ce produit au rebut, veuillez prendre contact avec les autorités locales ou avec votre revendeur et renseignez-vous sur la méthode de mise au rebut correcte.

Italiano

**Smaltimento delle attrezzature elettriche ed elettroniche usate (applicabile in tutta la Comunità Europea ed altri Paesi Europei che applicano programmi di raccolta differenziata)**

Il simbolo trovato sul prodotto, o sulla sua confezione, indica che il prodotto non può essere trattato come i domestici quando è il momento di smaltirlo. Al contrario, deve essere consegnato ad un centro di raccolta specializzato nel riciclaggio di attrezzature elettriche ed elettroniche. Assicurando che il corretto smaltimento di questo prodotto, si aiuterà a prevenire potenziali conseguenze negative sull'ambiente e sulla salute umana, che possono essere provocate da uno scorretto smaltimento di questa attrezzatura. I materiali riciclati aiuteranno a conservare le risorse naturali.



Questo simbolo è valido solo nell'Unione Europea. Per smaltire questo prodotto, mettersi in contatto con le autorità locali - o con il rivenditore - e chiedere informazioni sul corretto metodo di smaltimento.

Deutsch

**Entsorgung von elektrischen & elektronischen Altgeräten (geltend für die europäische Gemeinschaft und andere europäische Länder mit separaten Sammelprogrammen)**

Dieses Symbol, zu finden auf Ihrem Produkt oder dessen Verpackung, macht Sie darauf aufmerksam, dass dieses Produkt bei der Entsorgung nicht als Hausmüll behandelt werden darf. Statt dessen sollte es an eine Sammelstelle zum Recycling von elektrischen und elektronischen Altgeräten gegeben werden. Helfen Sie mit, potenziell schädliche Einflüsse auf Umwelt und Gesundheit, die durch eine unsachgemäße Entsorgung dieses Produktes entstehen können, zu vermeiden und entsorgen Sie dieses Produkt ordnungsgemäß. Recycling hilft, natürliche Rohstoffe einzusparen.



Dieses Symbol ist nur innerhalb der europäischen Gemeinschaft gültig. Wenn Sie dieses Produkt entsorgen möchten, wenden Sie sich bitte an Ihre örtliche Behörde und fragen Sie nach der ordnungsgemäßen Entsorgungsmethode.

Nederlands

**Verwijderen van oude elektrische en elektronische apparatuur (toepasselijk in de volledige Europese Unie en andere Europese landen met afzonderlijke programma's voor afvalverzameling)**

Dit symbool dat op het product of zijn verpakking is aangebracht, geeft aan dat dit product niet mag worden behandeld als huishoudelijk afval als u het wilt weggooien. U moet het afgeven bij een specifiek verzamelpunt voor de recycling van elektrische en elektronische apparatuur. Door te garanderen dat u dit product op de correcte manier wegwerpt, helpt u potentiële negatieve gevolgen voor het milieu en de menselijke gezondheid, die zouden kunnen worden veroorzaakt door een onrechtmatig wegwerpen van het product, te voorkomen. De recycling van materialen helpt het behoud van natuurlijke bronnen.



Dit symbool is alleen geldig in de Europese Unie. Als u dit product wenst weg te gooien, dient u contact op te nemen met uw lokale instanties voor details over de gepaste methode voor afvalverwijdering.

Polski

**Waste Electrical and Electronic Equipment (WEEE) Directive In the European Union, this label indicates that this product should not be disposed of with household waste. It should be deposited at an appropriate facility to enable recovery and recycling. EEE complies with Directive 'Regulation on the Restriction of the Use of Certain Hazardous Substances in Electrical and Electronic Equipment'**

Obecność tego symbolu na produkcie lub na opakowaniu z produktem oznacza, że tego produktu nie można wyrzucić razem z odpadkami domowymi. Należy go przekazać do punktu zbiórki w celu poddania recyklingowi pod specjalnych elektrycznych i elektronicznych. Usunięcie tego produktu w prawidłowy sposób, pomoże w zabezpieczeniu przed negatywnym wpływem odpadów na środowisko i zdrowie ludzi, powodowanym przez niewłaściwe usuwanie produktu. Przetwarzanie materiałów pomaga w zachowaniu zasobów naturalnych.



Ten symbol obowiązuje wyłącznie w krajach Unii Europejskiej. Informacje dotyczące prawidłowej metody usunięcia tego produktu, można uzyskać u władz lokalnych lub u dostawcy.

Suomi

**Waste Electrical and Electronic Equipment (WEEE) Yönergelei Avrupa Birliğinde bu etiket, ürünün ev elektroniği atıkları ile imha edilme sürecini gösterir. Kurulumak ve geri dönüştürülmesi için uygun şartlarda saklanması gerekir. EEE Yönetmeliğine Uygundur Ve Elektronik Eşyalar da Bazı Zararlı Maddelerin Kullanımının Sınırlanmasında Dair Yönetmelik.**

Jos tuoteessa tai sen pakkauksessa on tämä symboli, sitä ei pidä hävittää sen käteltä tavallisena kotitalousjätteenä, vaan se kuuluu toimittaa sähkö- ja elektroniikkalaitteiden kierrätyspisteeseen. Varmistamalla, että tämä tuote hävitetään asianmukaisesti tavalla, autat estämään mahdollisia ympäristö- ja ihmisten terveyttä koskevia negatiivisia seurauksia, joita sen väärin hävittäminen voi aiheuttaa. Materiaalien kierrättäminen auttaa säilyttämään luonnonvarjoja.



Tämä symboli on voimassa ainoastaan Euroopan unionin alueella. Jos haluat hävittää tämän tuotteen, ota yhteyttä paikallisiin viranomaisiin tai jälleenmyyjään ja tiedustele asiainmukaisia hävittämistapoja.

## Environmental condition for installation

- Since monitor is very sensitive for physical impact, installation requires considerable caution.
- Minimum clearance(20cm) must be secured for smooth ventilation. (See page 6) Installation must avoid air tight or near air tight places. Improper ventilation causes malfunction and shortens product lifetime by rapid internal temperature rise. If monitor has to be installed with the improper ventilation, additional ventilation openings or fans must be provided to keep the internal temperature between 0 ~ 35°C.
- For ground of monitor and application devices, it should be connected as frame ground.
- Considering monitor Max power consumption, check the main electric specification .

## Recommended Operating Condition

- Temperature: 5~35°C, Humidity: 35~75%, Suitable operating time : under 18 hours a day.
- Do not install the set at the air-tight condition.
- It is recommended to install the set with good ventilation.
- Do not install the set at the place of direct sunlight or excessive exposure to lightings.
- ※ Blackening, stains or burning effect on the screen can be occurred by improper installation or use against the above recommended conditions.

## Consideration for easier service

- When you design the exterior design for monitor system, consider easier disassembly for possible service occasion in the future.
- The sliding Universal Unit of ORION is recommended for easier service.
- If service people can step into the backside of monitor system, it can greatly reduce time and effort for service.
- In case of higher locations, consider the installation location and exterior design for easier service.

### ※ Clearance for Ventilation



- When you install monitor make sure there is at least 20cm clearance for effective ventilation and do not seal off monitor sets.  
 If monitor sets are installed at the locations of bad ventilation, the inner temperature can be raised rapidly and it can cause frequent malfunctions and rapid reduction of the product life.

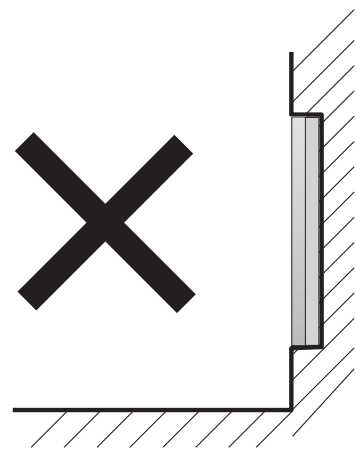
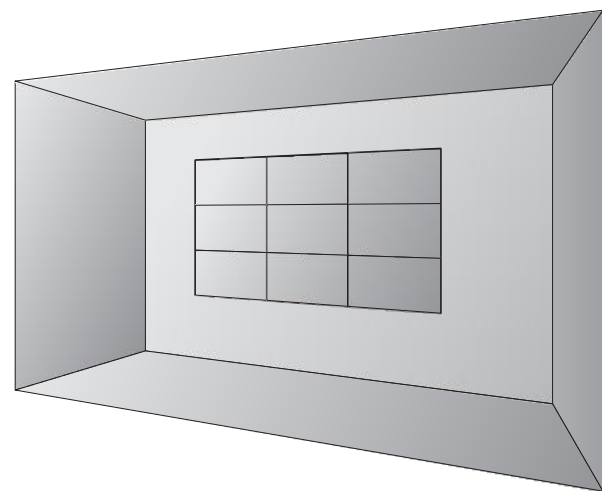
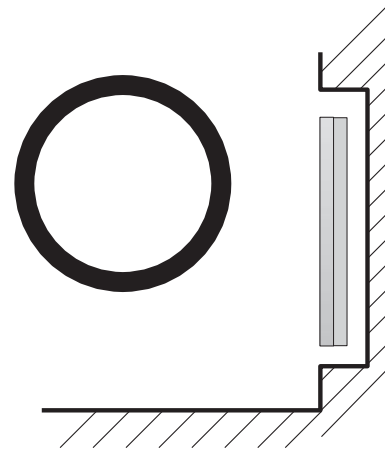
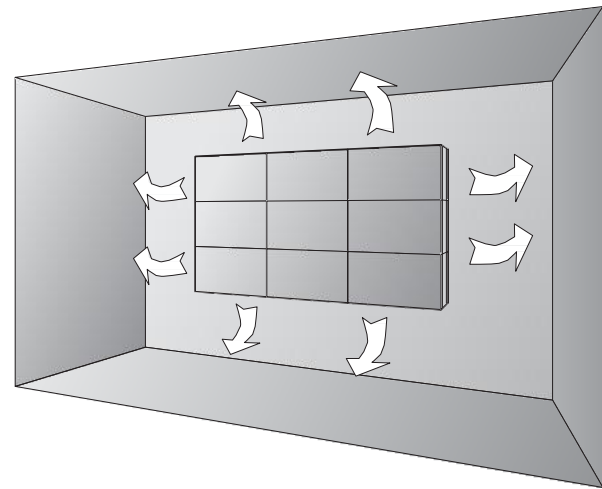

\* Ventilation space in front of monitor must be furnished for heat dispersion. If the front space of monitor has to be sealed, there must be consideration for the heat dispersion in the rear side of monitor.

### ※ Cleaning and Maintenance



- Regularly clean off the vent holes in the back of monitor sets.  
 If the vent holes and the fan air holes are clogged with dust, it prevents the air flow inside of monitor sets.  
 It can cause rapid increase of the inner temperature and may cause malfunctions.  
 Clean off the vent holes and the fan air holes with a vacuum cleaner regularly.

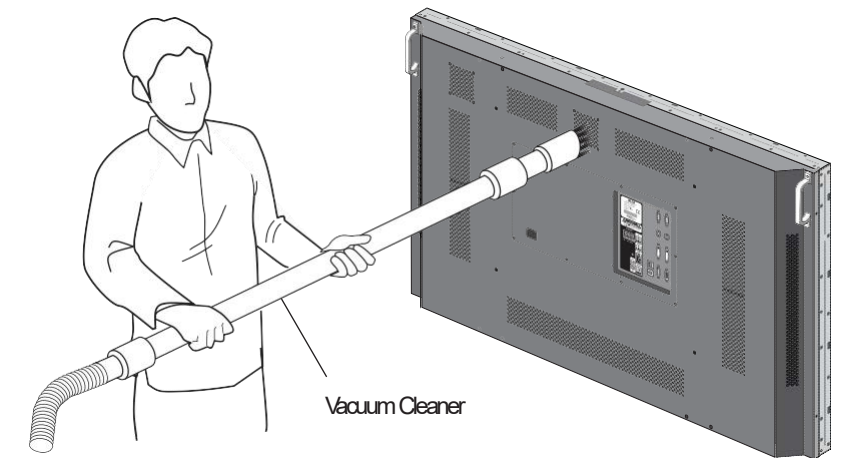

WARNING

WARNING

WARNING



**⌘ Please keep following instructions for panel protection without exception.**

- This product can be damaged even with minor impact for its nature. Please keep following instruction to carry or store the products.

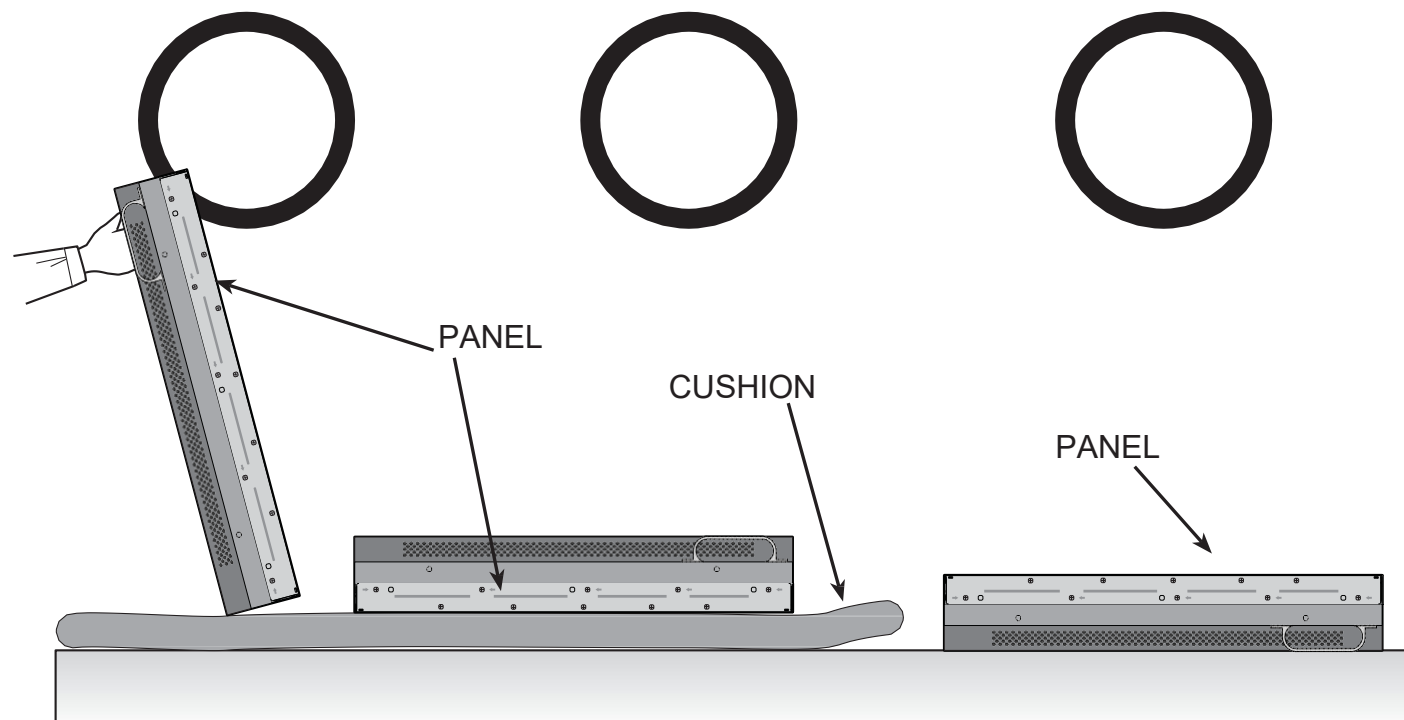

- If you need to stand LCD,
- If you need to lay down
- If you need to lay down LCD

you must lean over the LCD to avoid panel touches ground or floor .

LCD as face down position, please use shock-absorbing pads under the LCD.

as face up position, please be cautious for falling objects on the surface of the LCD.

WARNING



**⌘ Handle with Caution.**

- Shock/Impact on the set's sides will result in internal circuit damages.  
- The edge/bottom of the panel are fragile. Use shock-absorbing pads or rugs for laying down the product.

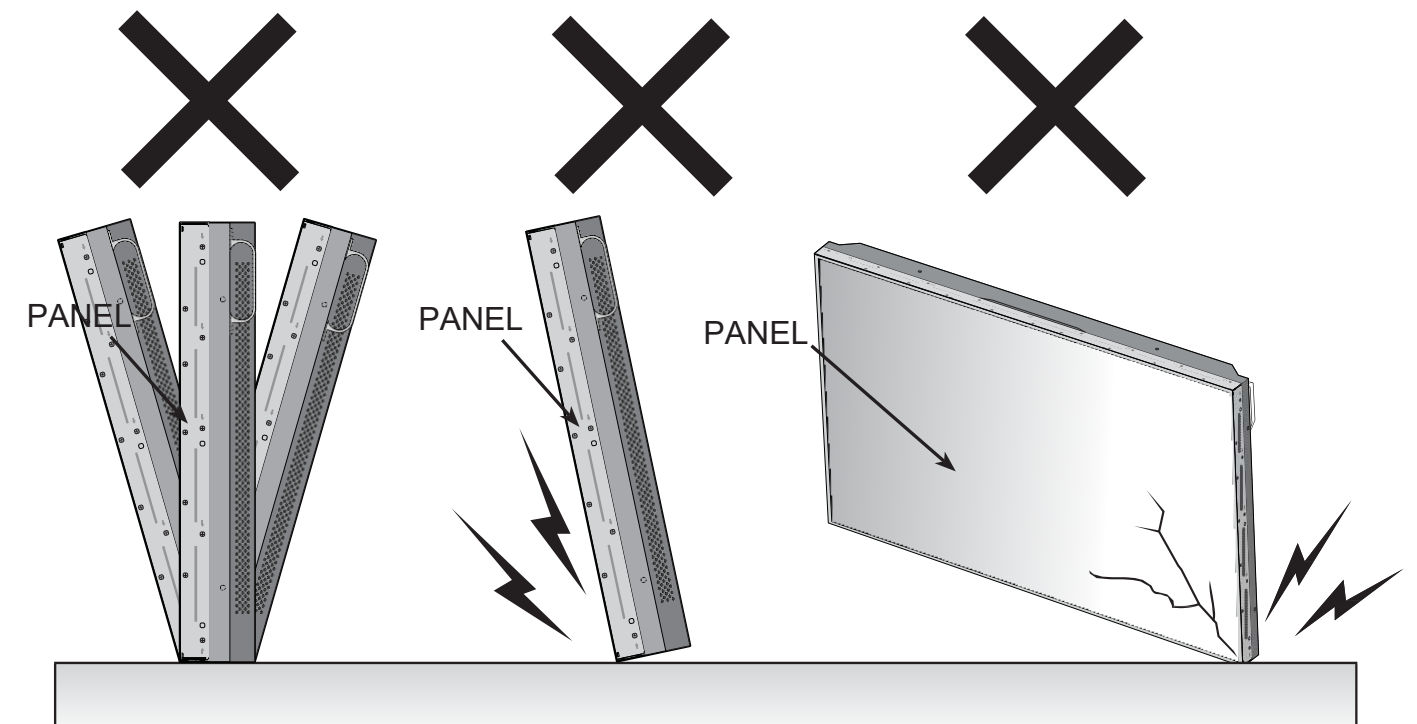

- Please do not stand LCD
- Please do not lean over
- Please do not lean over the

alone. It may fall or slip off and Panel can be broken or damaged.

the LCD. It may damage the bottom part of the LCD.

LCD toward the edge part. It may damage the edge part of the LCD.

## ※ How to carry

It always needs two persons to carry or install monitor .

When you carry monitor with up straight manner, please hold handles on the back and bottom part of the panel together.

Please be careful not to touch the bottom part of the panel when you put down the panel.

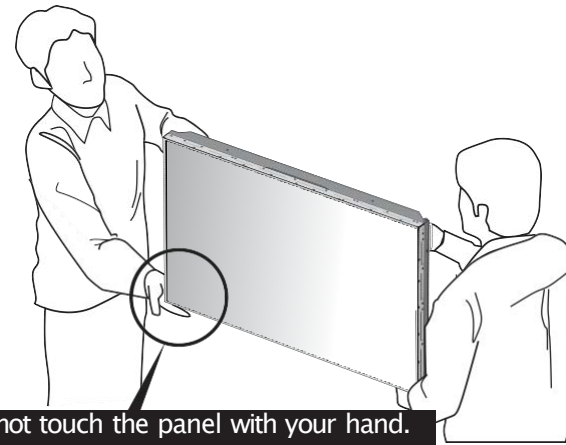

Please do not touch the panel with your hand.

Don't carry monitor in Horizontal Status.

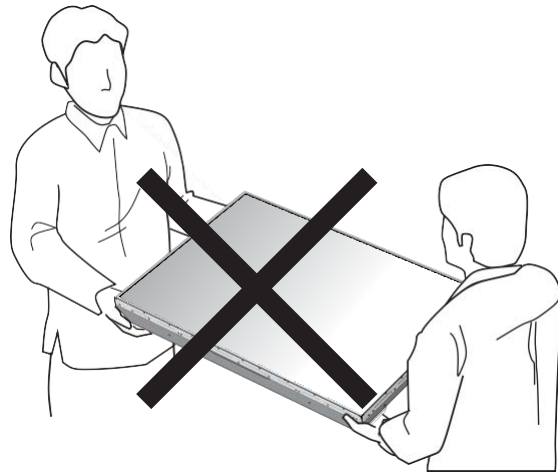

When two operators uphold monitor, Panel is twisted by unbalanced handling.

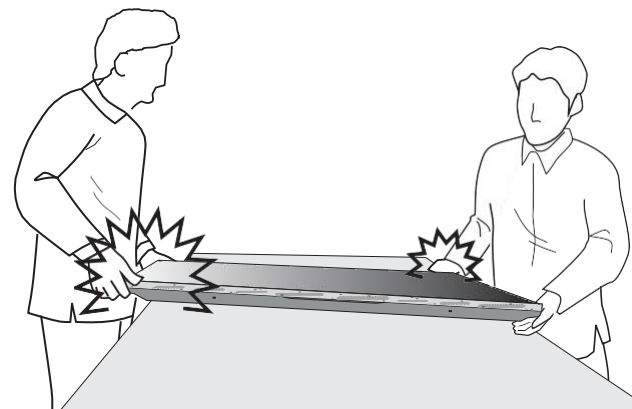

## ※ Application information

If static images are displayed on the screen for a long time, it causes burn-in image. Please keep the following instruction to optimize the lifetime and functions of the product.

### 1. Operating condition

- Temperature: 20 ± 15°C
- Humidity: 55 ± 20 %
- Display pattern: moving picture or regular switchover display
- Environmental condition : Well ventilated place is recommended.
- Power off and screen saver : Periodical power-off or screen saver is needed after long-term static display.

※ Note : Moving picture or black pattern is strongly recommended for screen saver.

### 2. Operating methods to minimize burn-in image due to long-term static information display

- For optimal performance, we suggest turning off the LED power on the monitor for four hours per day
- Periodical display contents change from static image to moving picture.
- Periodical background color and character (image) color change

DEPARTURE		
Flight No.	Time	Gate
UA 012	11:20	A02
KE 732	12:10	K17
AN 291	12:45	F11

DEPARTURE		
Flight No.	Time	Gate
UA 012	11:20	A02
KE 732	12:10	K17
AN 291	12:45	F11

- Change the images of little luminance difference between the background and characters, periodically.

DEPARTURE		
Flight N	Time	Gate
o. UA 012	11:20	A02

DEPARTURE		
Flight N	Time	Gate
o. UA 012	11:20	A02

DEPARTURE		
Flight N	Time	Gate
o. UA 012	11:20	A02

DEPARTURE		
Flight N	Time	Gate
o. UA 012	11:20	A02

- It is not recommended to display the images of huge luminance difference between the background and characters or the images of grey tone.

ARRIVAL			
Flight No.	Time	Gate	Delay
AA 213	9:20	K11	On time
OZ 621	11:25	G21	10 min.
JA 032	12:05	A19	On time

ARRIVAL			
Flight No.	Time	Embark	Delay
AA 213	9:20	New York	On time
OZ 621	11:25	Seoul	10 min.
JA 032	12:05	Beijing	On time

- Scroll the characters periodically.

DEPARTURE		
Flight No.	Time	Gate
UA 012	11:20	A02
KE 732	12:10	K17
AN 291	12:45	F11

Æ

DEPARTURE		
Flight No.	Time	Gate
UA 012	11:20	A02
	13:40	K17
UA 012	17:03	A02

Æ

DEPARTURE		
Flight No.	Time	Gate
UA 012	11:20	A02
KE 732	12:10	K17
AN 291	12:45	F11

(Whole Screen Scroll)



### ※ Attention for Installing

Warning

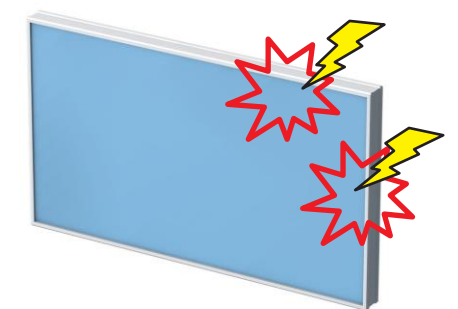
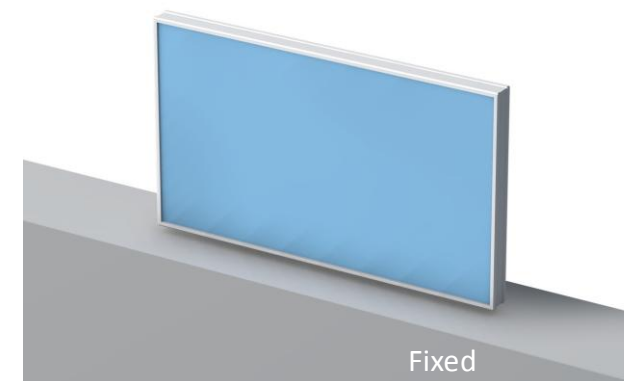
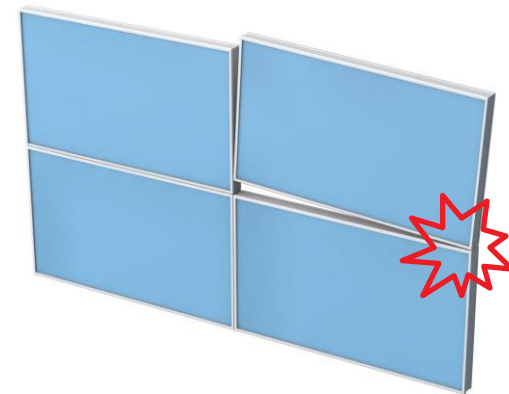
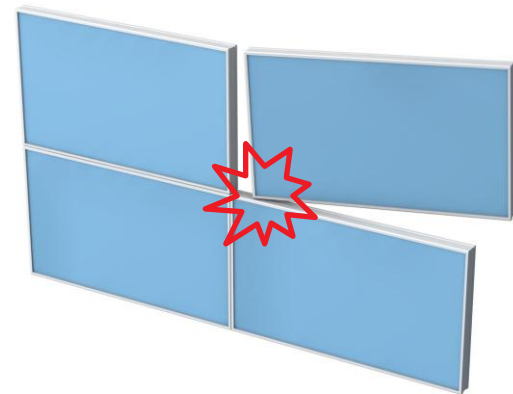

- Avoid giving a shock or damage at LCD corner or other parts during setting Multi-Vision.

- Keep all LCDs balanced in vertical or horizontal force after setting
- Multi-Vision. Avoid LCD is set up tilted so it can give a damage to down LCD.

- Avoid that LCD is twisted.

- Avoid that LCD outside is shocked or damaged by sharp thing.



# 01. Safety Precautions

- If it operates abnormally, stop using it immediately.

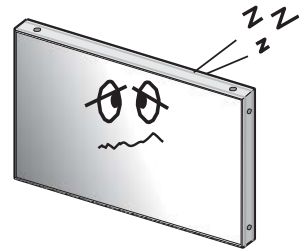

- Do not place any liquid-containing container on it. If the inside is wet, it may cause electric shock or fire.

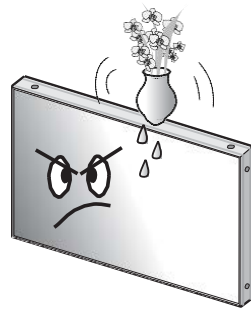

- Do not put any foreign material into the product. It may cause a failure or shorten the life span.

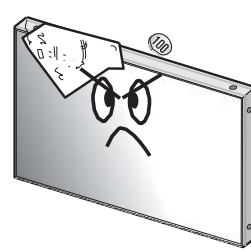

- Please refer to a specialized construction company for installing stand or wall mount unit. Otherwise, damage or injury may be caused.



- Do not touch the device when lightning strikes.

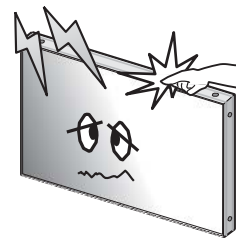

- Do not install in an unstable location. It may cause injury.

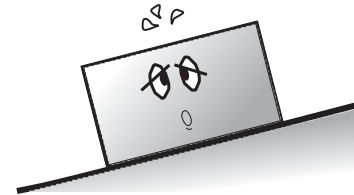

- Avoid any action to damage the power cord or power plug. It may cause fire or electric shock.

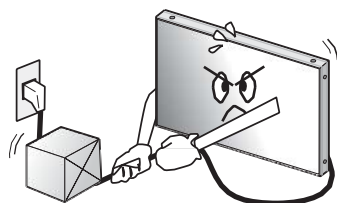

- Do not pull out the power plug with a wet hand. It may cause electric shock.

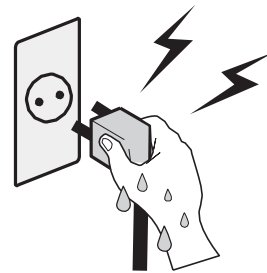

- Do not exceed ratings of AC outlet or extension cords. It may cause failure.

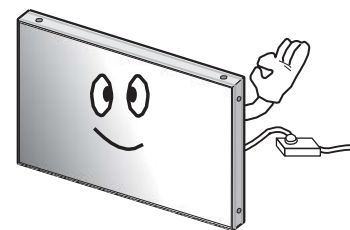

- Do not alter (or disassemble) the product. It may cause electric shock since high voltage is flowing inside.

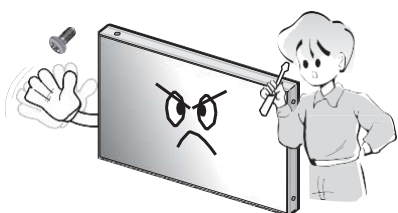

- Do not install the product where it may be exposed to direct sunlight or near any heating device. It may shorten the product's life span or cause failure.

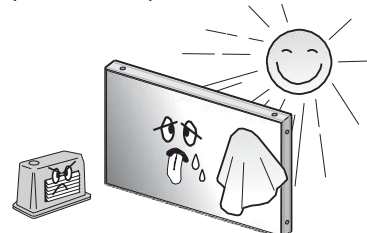

- Make sure the product is not covered with any object. If the ventilation hole is blocked, the inside temperature may rise to cause overheating resulting in fire.

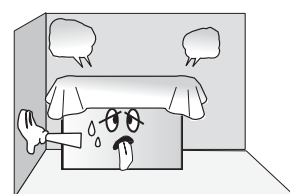

- Do not pull out or hang down the connection cable. It may damage the cord to cause fire or electric shock.

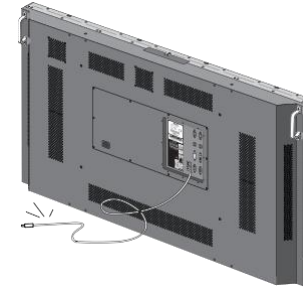

- Do not lean against the product or keep it leaned. It may cause injury or failure.

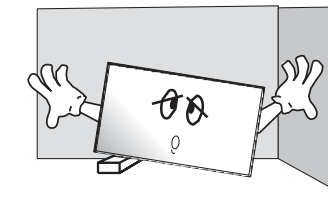

- Do not put it at any place with much humidity, dust, oil, smoke or steam. It may cause failure.

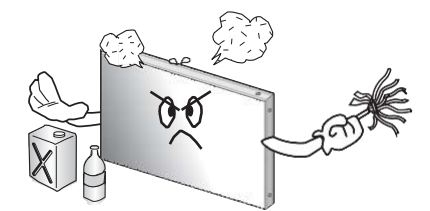

- Pull out the power plug by holding the plug. Otherwise, it may damage the power cord to cause fire or electric shock.

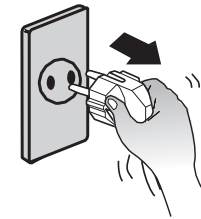

- If you do not want to use the product for a long time, keep the power plug unplugged to save electricity.
- The socket-outlet should be installed near the equipment and be easily accessible.

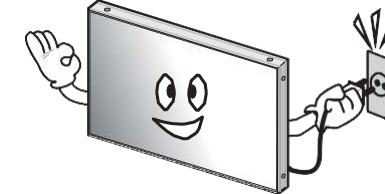

- Do not put any heavy object on it. It may cause failure.

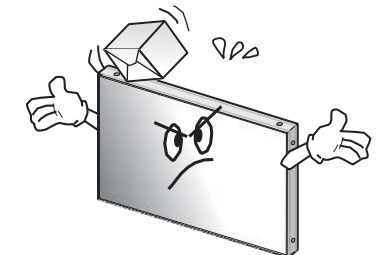

- Install the product on safe and flat surface.

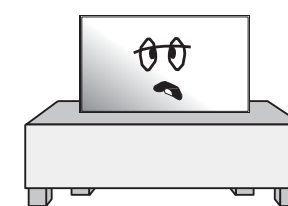

- Do not ride or step on the product. It may cause breakage when fallen down.

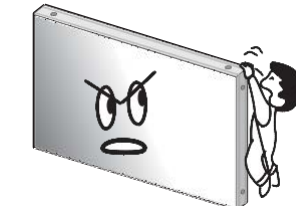

- When moving it, disconnect the connecting cable. Otherwise, it may damage the cable to cause fire or electric shock.

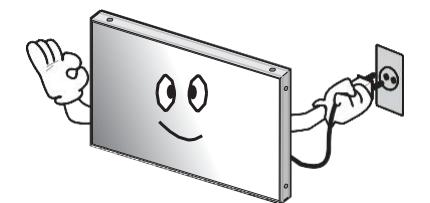

- Do not put candles on the product. If the liquid flows inside the product. It may cause electric shock or fire.

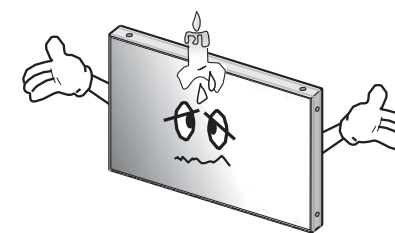

- Do not touch product's front surface with hand. Otherwise, the image quality can be lowered.

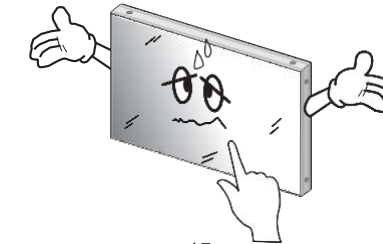

- Do not poke the front screen with sharp material. It may damage the screen and may cause malfunction of the product.

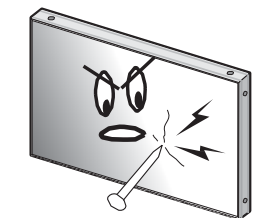

## 02. Names

### ▶ Front



### ▶ Rear

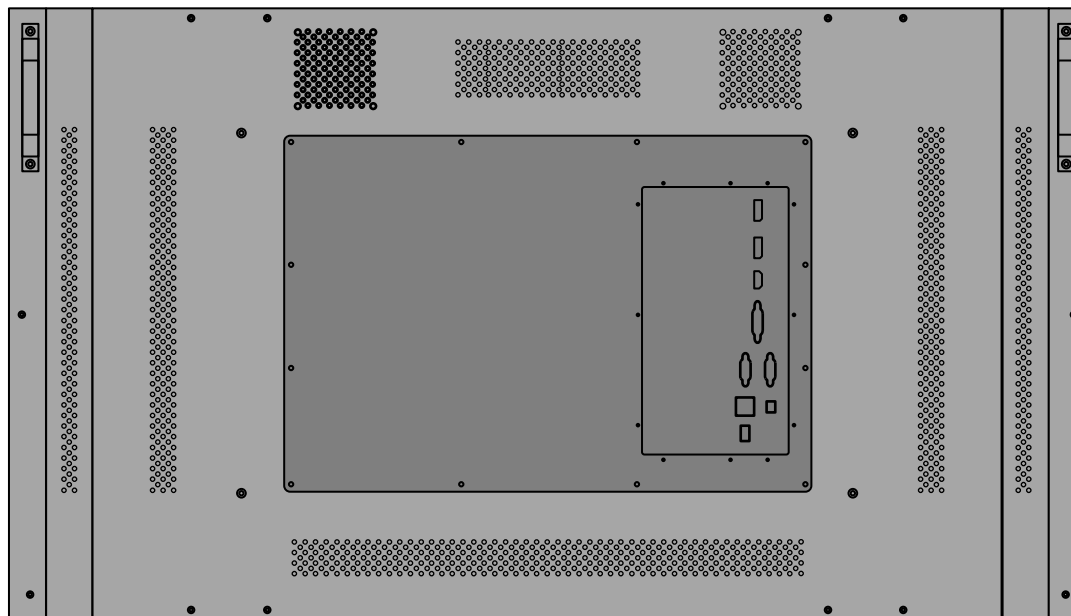

### ▶ Input Ports

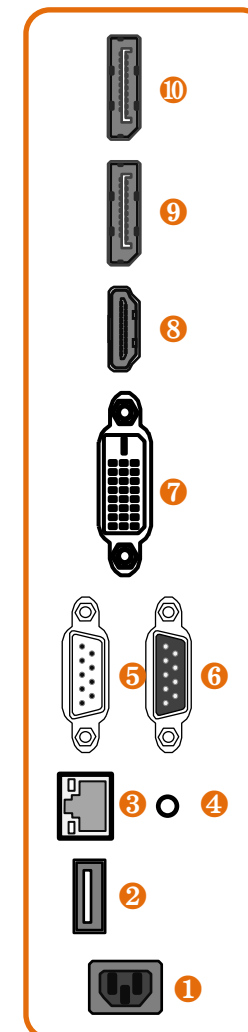
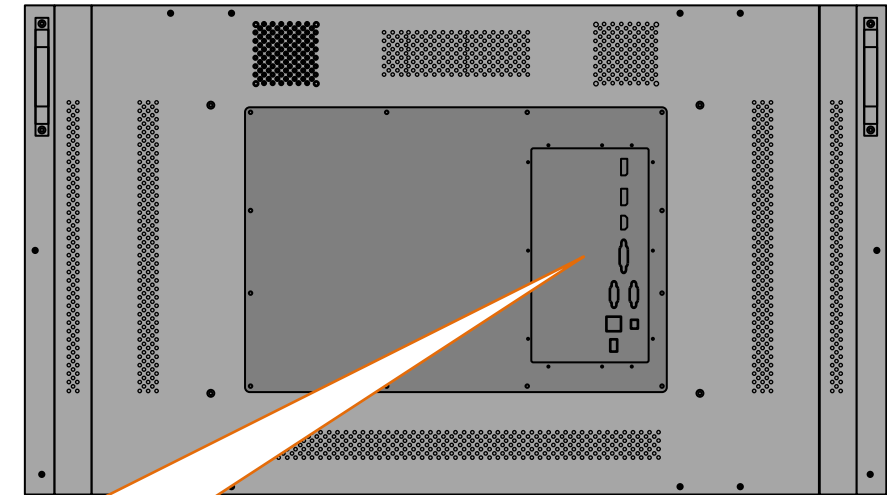

- |   |  |
|---|--|
| <p><b>1. AC IN</b><br/>AC 100V ~ 240V, 50/60Hz</p> <p><b>2. A/S</b><br/>Only for Firmware upgrade.</p> <p><b>3. LAN</b><br/>Display control via Ethernet (RJ45)</p> <p><b>4. IR</b><br/>Remote controller input port</p> <p><b>5. RS232C IN</b><br/>Display control via COM port<br/>(D-Sub 9pin, FEMALE)</p> | <p><b>6. RS232C OUT</b><br/>Display control via COM port<br/>(D-Sub 9pin, MALE)</p> <p><b>7. DVI IN</b><br/>To input Display Port signals</p> <p><b>8. HDMI IN</b><br/>To input HDMI video signal.</p> <p><b>9. DP IN</b><br/>To input DisplayPort video signal.</p> <p><b>10. DP OUT</b><br/>For loop through video with other<br/>monitors for sharing video signal through<br/>DisplayPort.</p> |
|---|--|

### 03. How to Connect Cables

- Do not connect/disconnect cables while monitor or other external equipments are turned on.
- First turn off the power all the attached equipment and make connections.
- Make sure the power cord is inserted properly into the power inlet to prevent unexpected pullout of the cord.

#### 3.1. Connection of Single

- Monitor and PC should be connected; a Com Port in a PC and RS-232C IN port in a monitor is connected with supplied RS-232C cable.
- If you do not have Com Port, you need to use an USB converter for RS-232C. Depending on manufacturers or models, converters may cause malfunction.

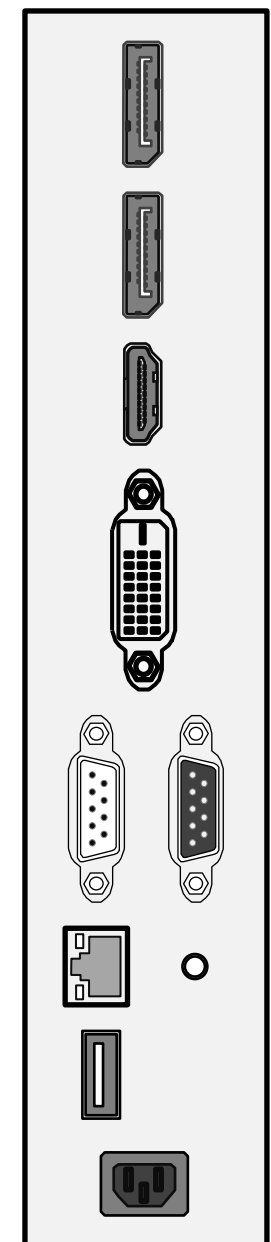
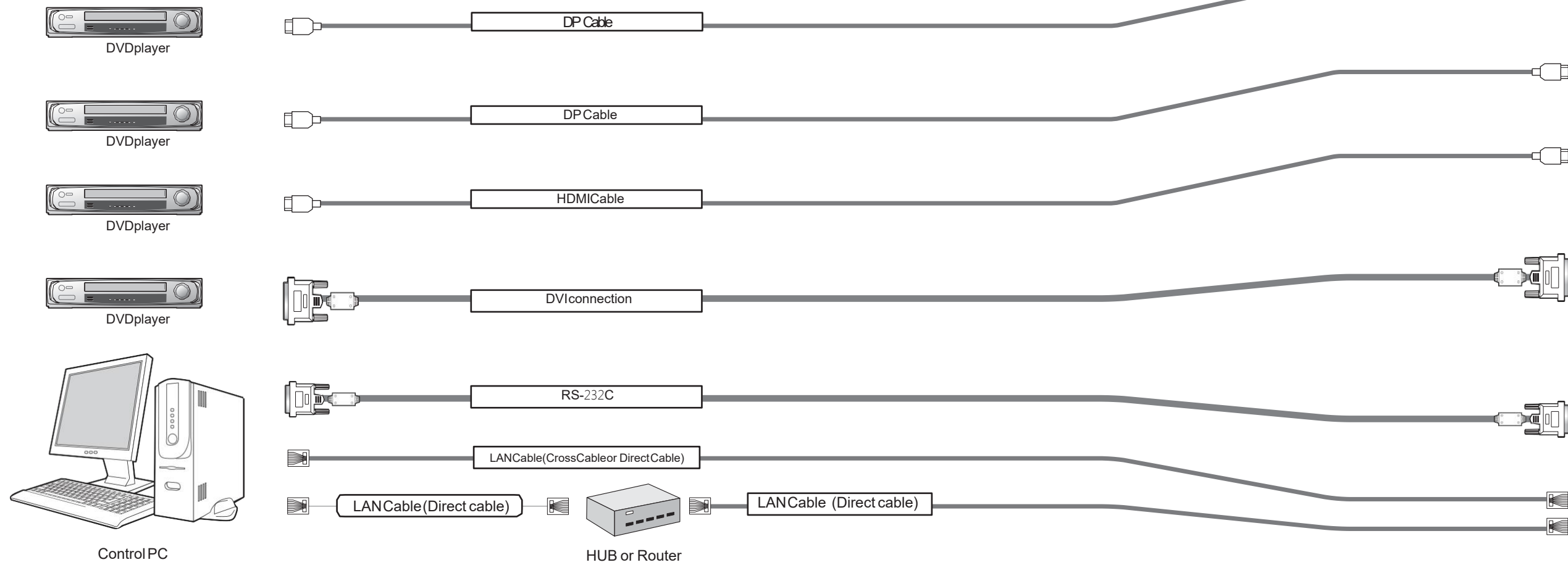
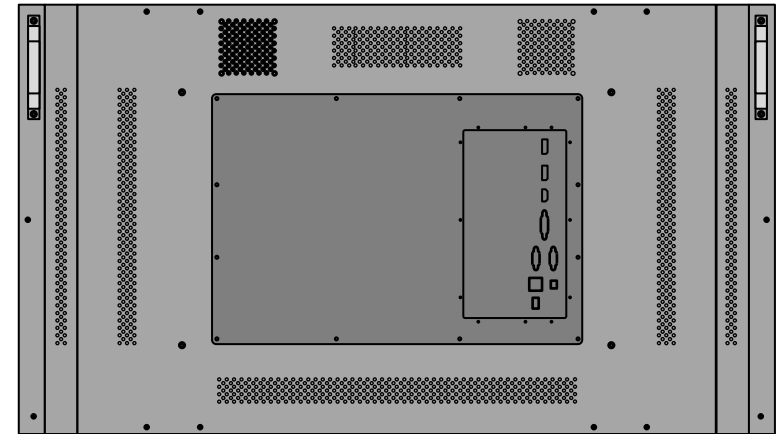

### 3.2. Connection of Multiple (for DP in)

- Image quality can be affected by cable or signal quality.
- Please use DisplayPort cable with DisplayPort certified logo.
- Select DisplayPort cables feature a locking function. When removing this cable, hold down the top button to release the lock.
- Recommended maximum set connection for Multi setting is shown in table below. If you need to connect more than described in the table, you have to use distributors.

INPUT SOURCE	Resolution	Output Port	Connection	Remark
DP	3840 x 2160 x 60Hz	DP OUT	6 sets	HDCP Available

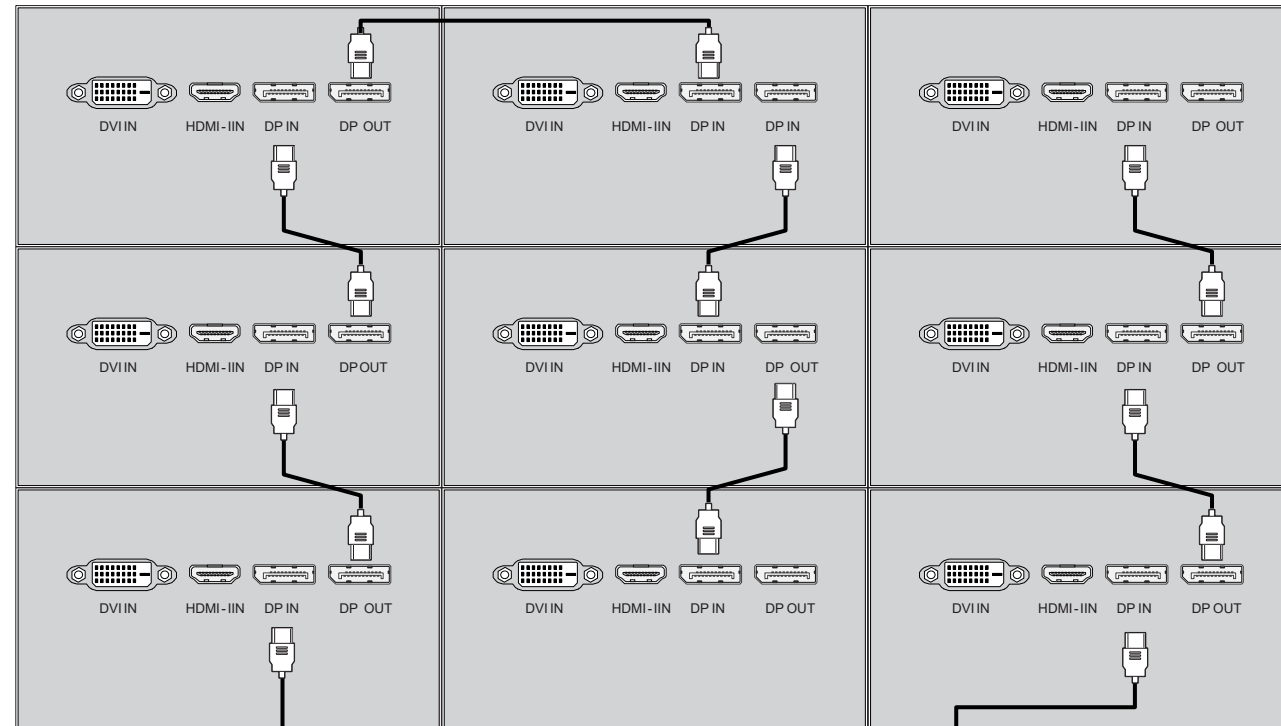

※Caution for DP Signal Distributor

If you want to display HDCP (High-bandwidth Digital Content Protection) applied contents, you must use the distributor that supports HDCP function.

VideoSource

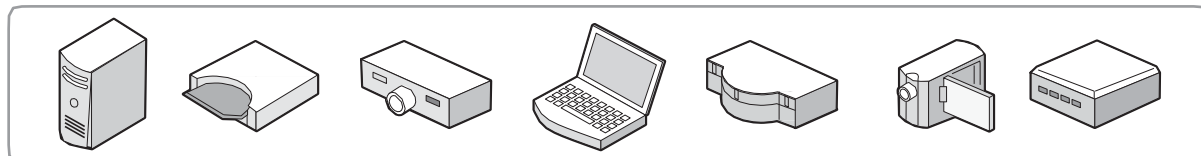

### 3.3. Connection of Multiple (for HDMI in)

- It is recommended you purchase an HDMI-certified cable. Otherwise, the screen may appear blank or a connection error may occur.
- Image quality can be affected by cable or signal quality.

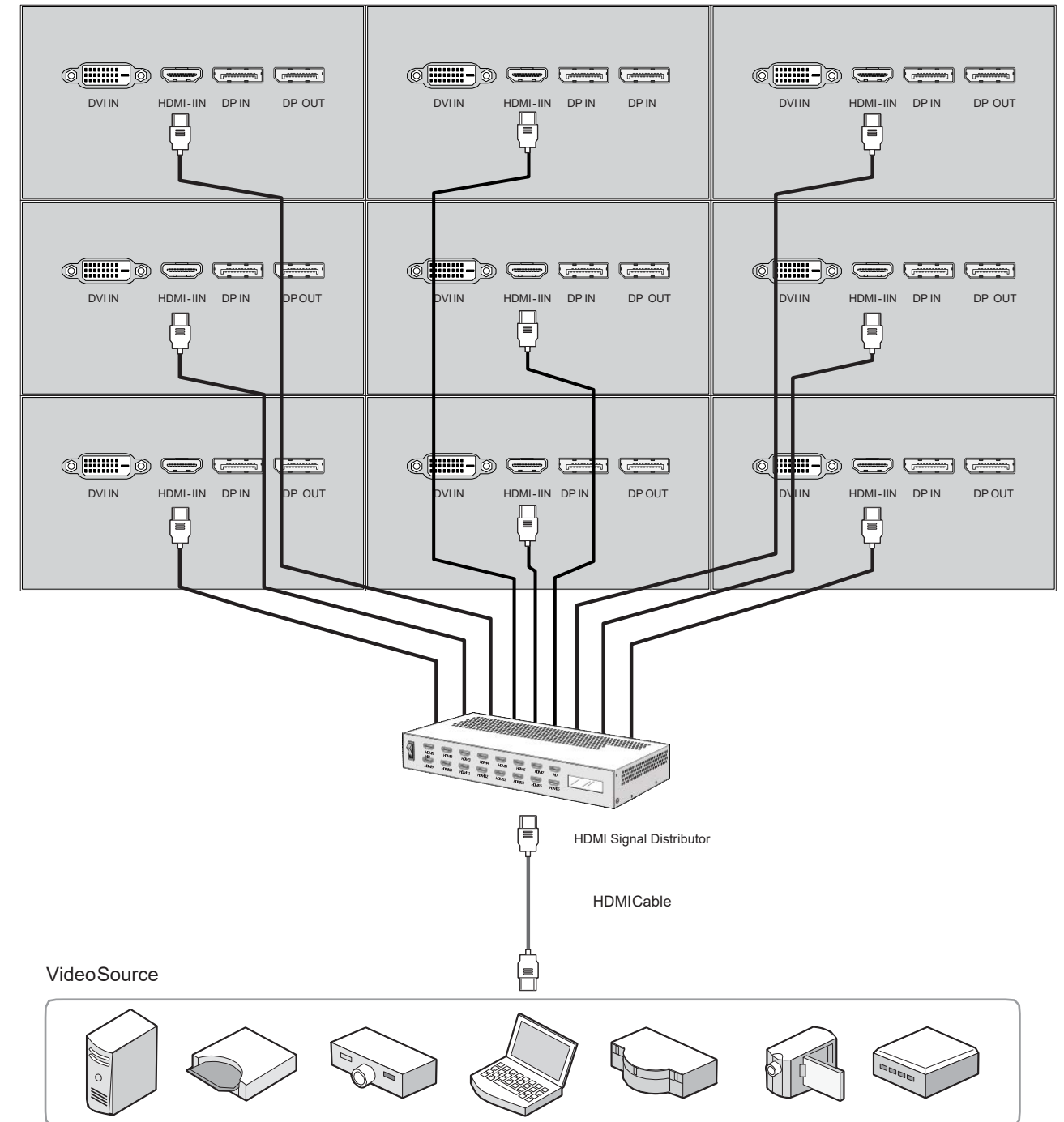

HDMI Signal Distributor

HDMICable

VideoSource

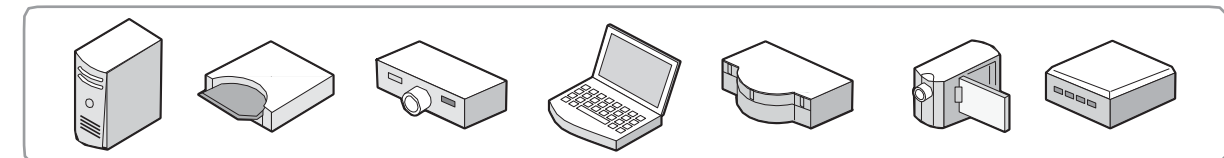

### 3.4. Connection of Multiple (for DVI in)

- Image quality can be affected by cable or signal quality.

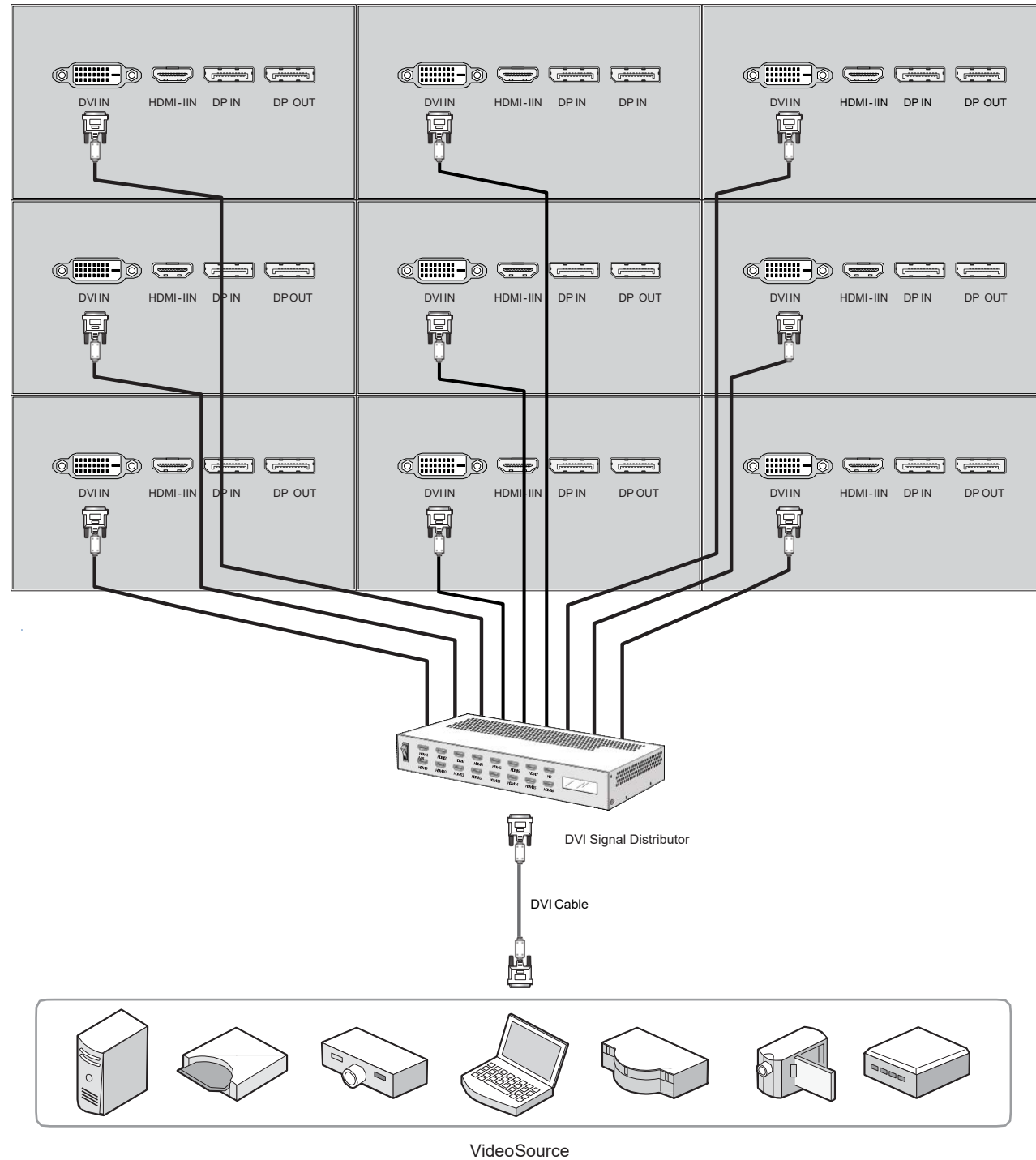

### 3.5. Connection of Control Cable

- Control signal transmission can be connected by 3 different methods. (RS-232C or Ethernet or IR)
- RS-232C and Ethernet connection cannot be used simultaneously.
- All control signals are output to the RS-232OUT after conversion to RS-232C signal.

#### 3.5.1. Connection of RS-232C Cable

- Maximum use of RS-232C with Daisy Chain connection is 30 sets or less, if you need additional connection, use RS-232C distributor.

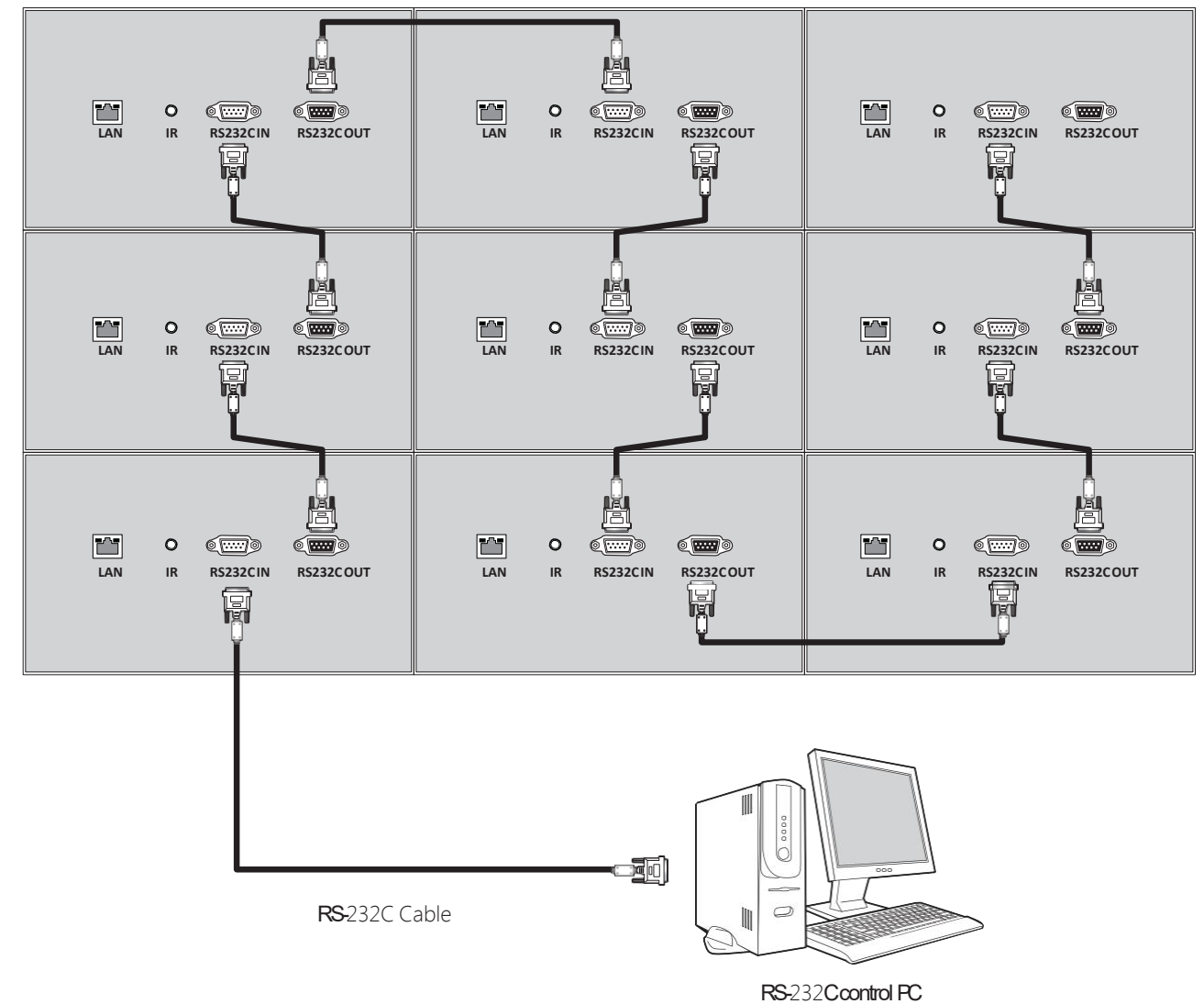

### 3.5.2. Connection of Ethernet Cable

- In case of Ethernet connection, the control PC should be connected to one of monitor sets with Ethernet cable. For the connection between the monitor sets, they should be connected with RS-232C cables.

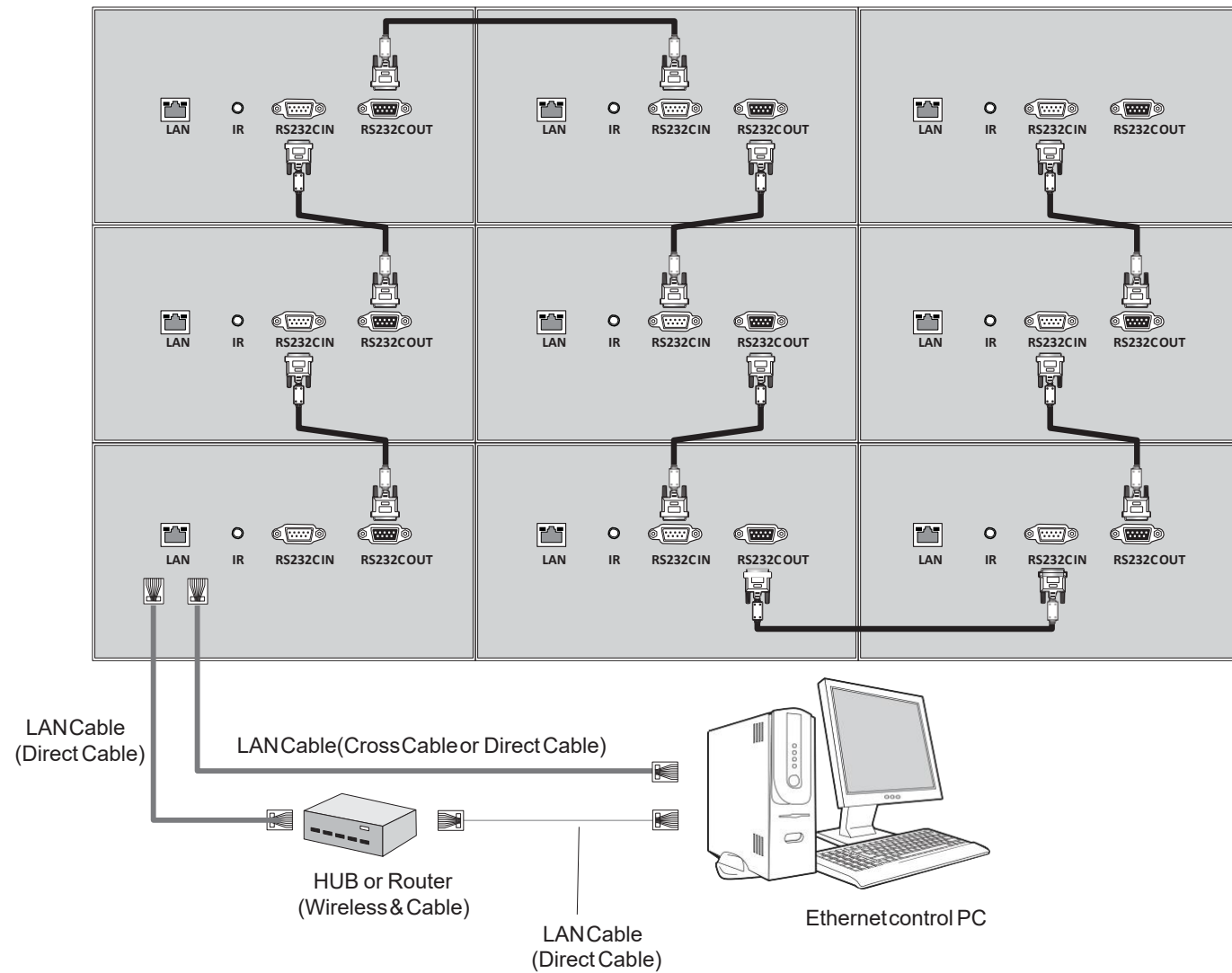

## 4. ID Setting

- Refer to the next chapter for OSW use.
- Before ID Setting Using OSW, Make sure that all of the connected MLCD sets are turned on by clicking "POWER ON" button in Broadcast.  BROADCAST MODE

### 4.1. Sequential Connection

- It is the sequential RS-232C cable connection according to the order of ID numbers.

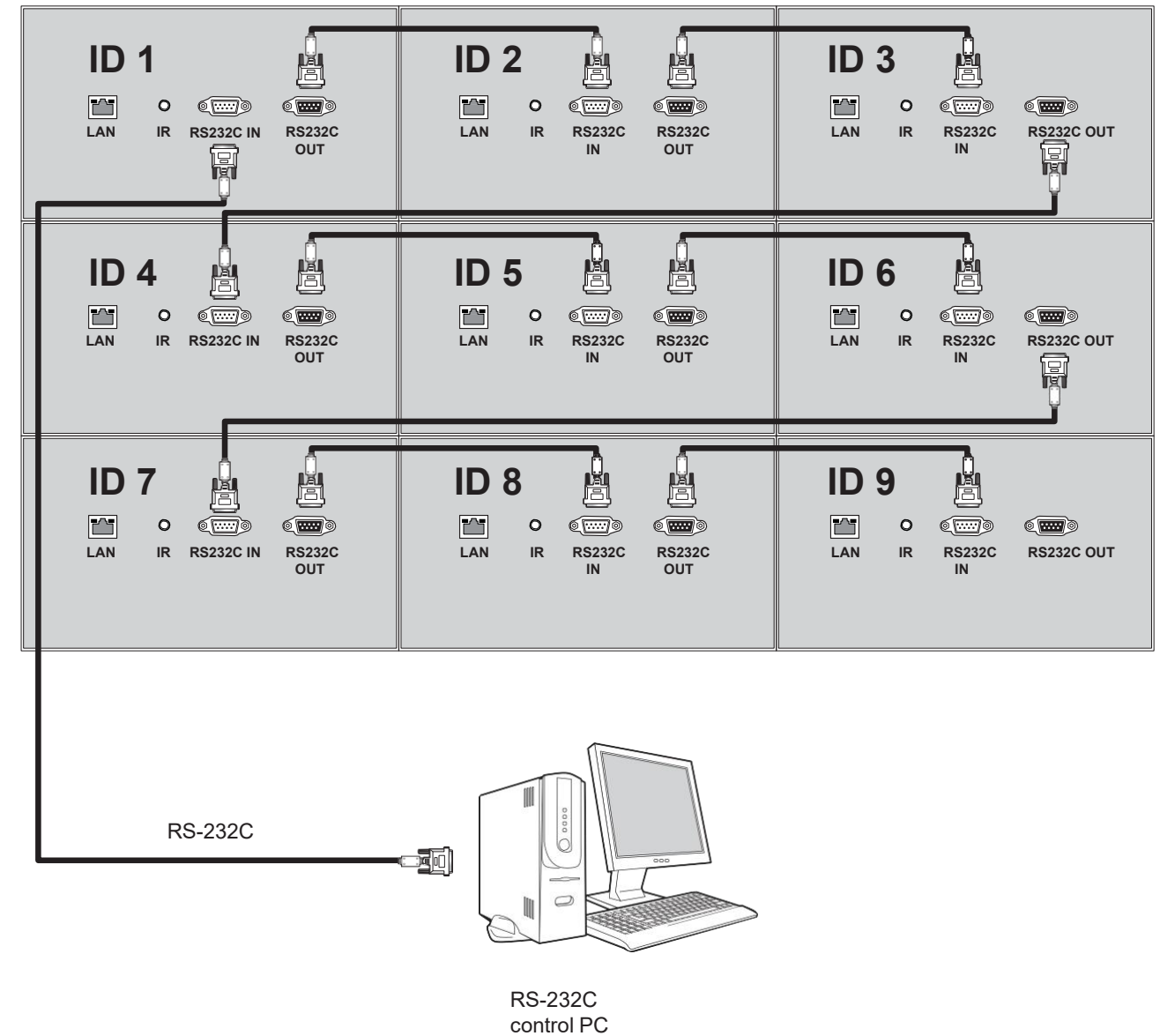

1. Click "MULTI → ID"
2. Click "AUTO ID SET" button in "ID" tab to complete ID setting.

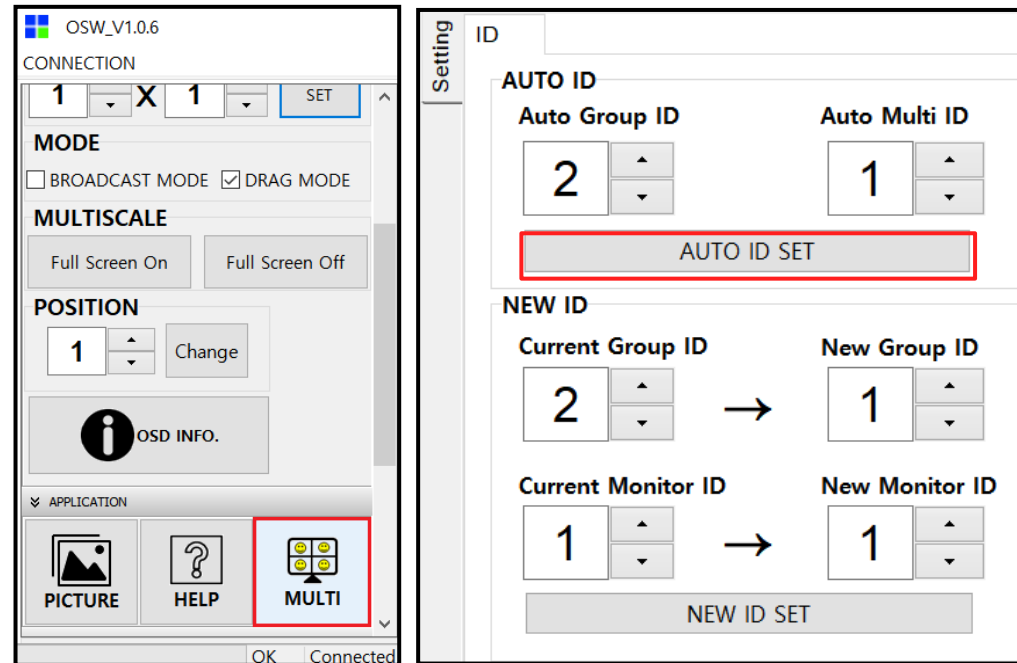

3. After that, ID setting status in OSW Screen Configuration is as follows. It's same as physical RS-232C cable connection. Because "AUTO ID SET" sets the order of ID numbers according to the sequential RS-232C cable connection.

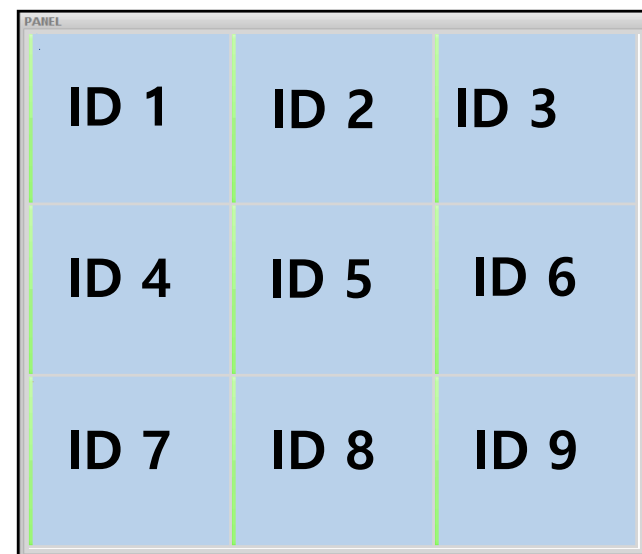

### 4.2. Random Connection

- It is the random RS-232C cable connection regardless of the order of ID numbers.

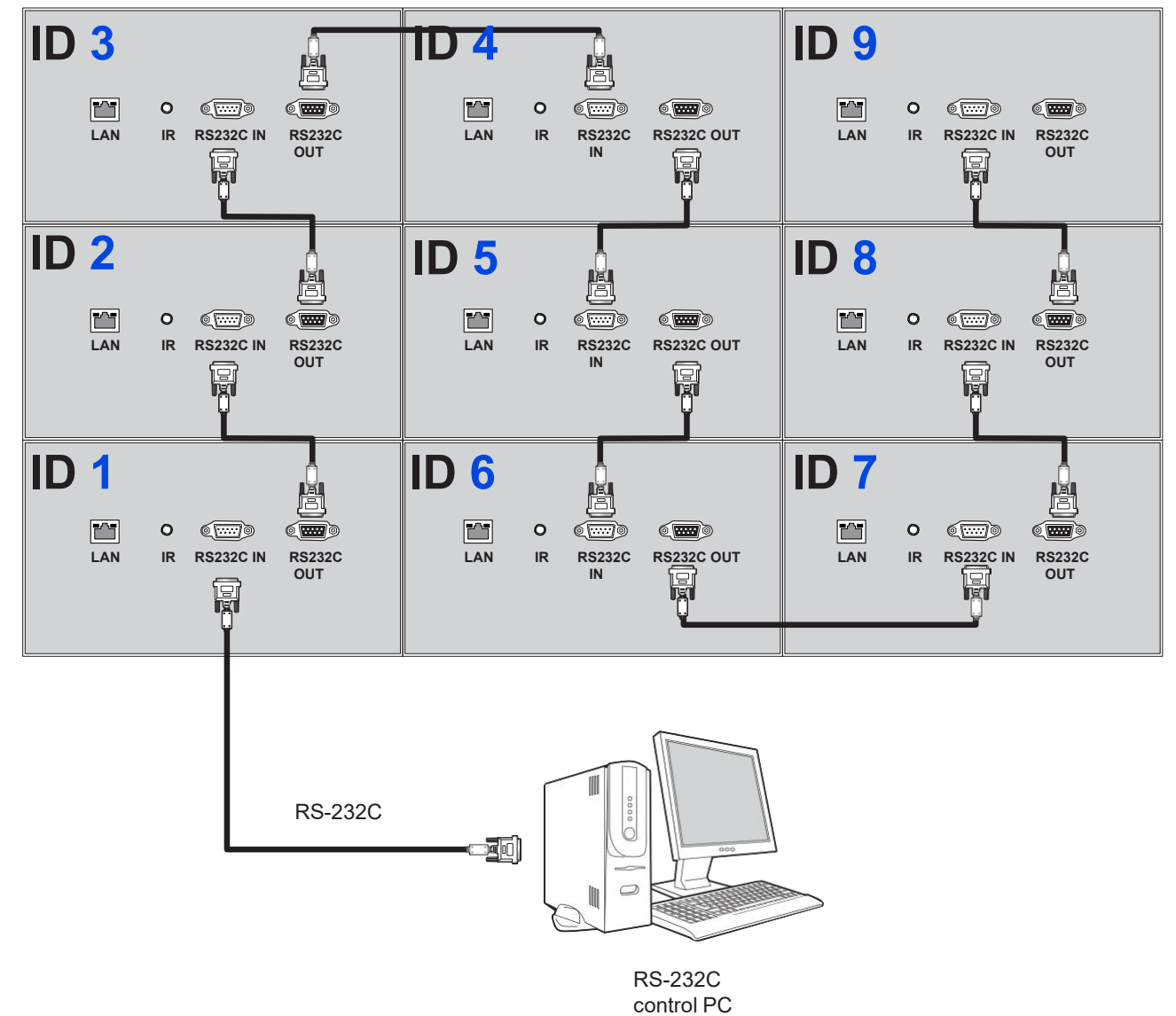

1. Click "MULTI → ID".
2. Select another number, which is not in use, for "AUTO GROUP ID" and click "AUTO ID SET" in "ID" menu

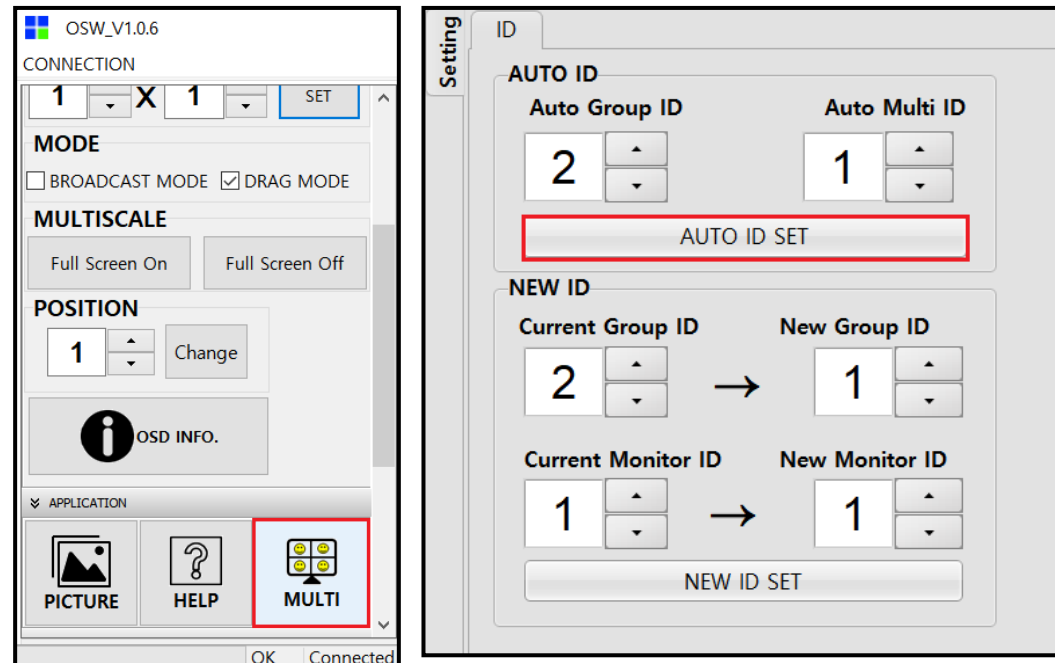

3. After that, ID setting status in OSW Screen Configuration is as follows. It's same as physical RS-232C cable connection. Because "AUTO ID" sets the order of ID numbers according to the sequential RS-232C cable connection.  
\* Group ID = GID, Monitor ID = MID

GID 2 MID 3	GID 2 MID 4	GID 2 MID 9
GID 2 MID 2	GID 2 MID 5	GID 2 MID 8
GID 2 MID 1	GID 2 MID 6	GID 2 MID 7

4. Identify the IDs of all connected MLCD sets by clicking "INFO" button in Broadcast.
5. First, Identify the IDs of upper left corner MLCD set.
6. Set the IDs identified through the above 4,5) procedure for "CURRENT GROUP/MONITOR ID" in "NEW ID" Menu. And then, set "NEW GROUP ID" as 1 and "NEW MONITOR ID" as 1 in "NEW ID" Menu. And click "NEW ID SET" button in "NEW ID" menu.

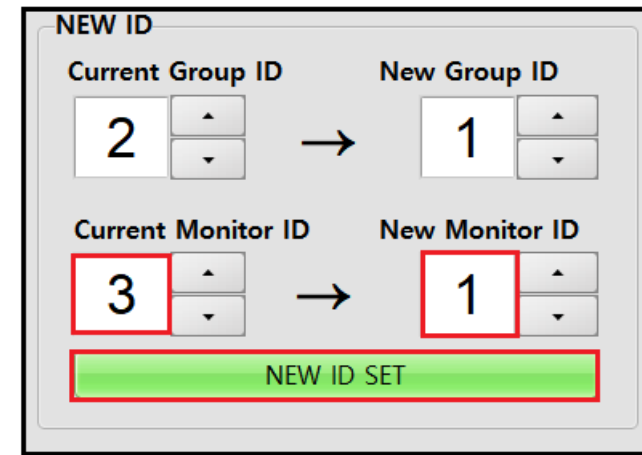

ID 3	ID 4	ID 9
ID 2	ID 5	ID 8
ID 1	ID 6	ID 7

Group ID 2, Multi ID 3



ID 1	ID 2	ID 3
ID 4	ID 5	ID 6
ID 7	ID 8	ID 9

Group ID 1, Multi ID 1



- Identify the IDs on the right MLCD set of upper left corner MLCD set in the same way as the above 4) procedure.
- Set the IDs identified through the above 7) procedure for "CURRENT GROUP/MULTI ID" in "NEW ID" Menu. And then, Increase the number by 1 for "NEW MONITOR ID" in "NEW ID" Menu to set the ID order. and click "NEW ID SET" button in "NEW ID" menu.

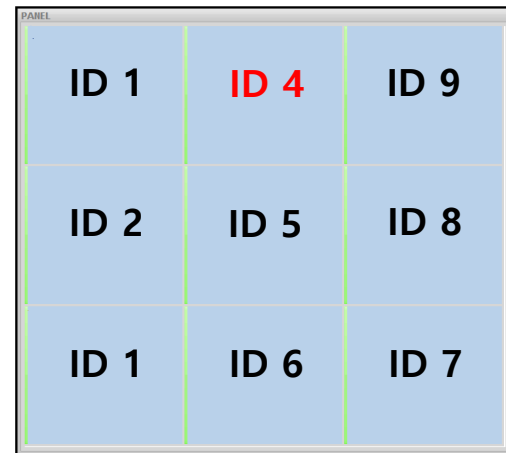
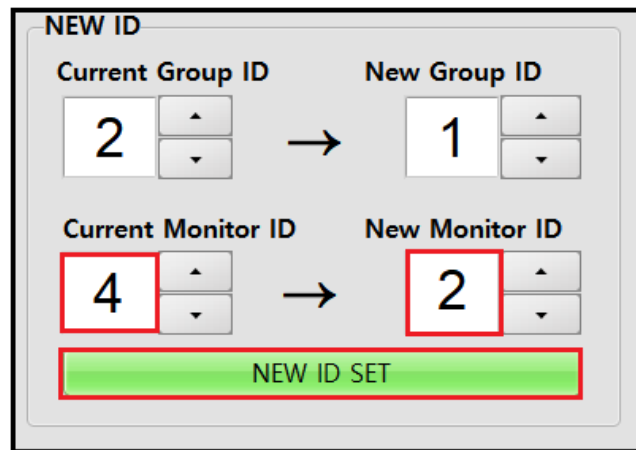

Group ID 2, Multi ID 4

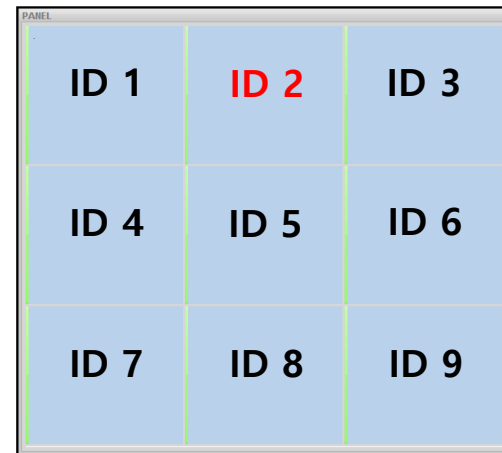

Group ID 1, Multi ID 2

- Repeat the above 7) and 8) procedures for the rest of displays in the same order as the number of the 10) procedure's capture view.
- After setting last MLCD set, ID setting status in OSW Screen Configuration is as follows. It's different from physical RS-232C cable connection.

Current Group ID		New Group ID
2	→	1

Current Monitor ID		New Monitor ID
3	→	1
4	→	2
9	→	3
2	→	4
5	→	5
8	→	6
1	→	7
6	→	8
7	→	9

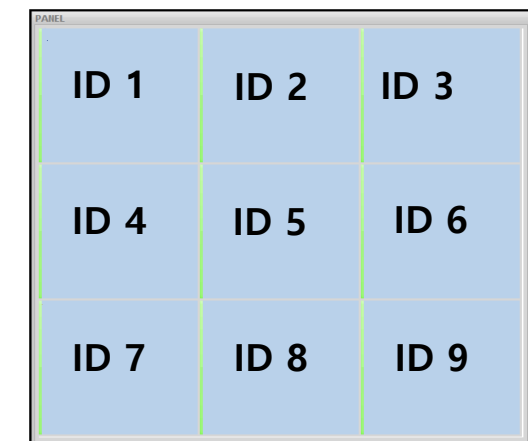

## 5. OSD Menu

### 5.1. Picture Menu

- Use this menu to activate Brightness/Contrast/sharpness and the luminance of the backlight adjustment.

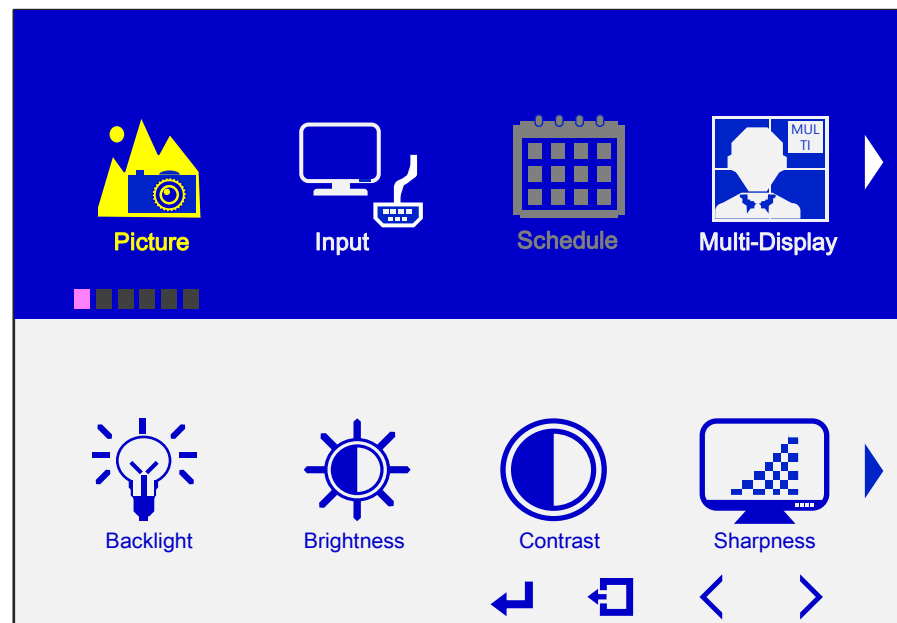

[Picture Menu Table]

MENU	SUB MENU	DESCRIPTION	RANGE
Picture	Backlight	Backlight adjusts the luminance of the backlight.	0 ~ 100
	Brightness	Brightness adjusts the brightness of the monitor.	0 ~ 100
	Contrast	Contrast adjusts the difference between darkness and lightness on the monitor. Adjust the brightness first, and then adjust the contrast only if further adjustment is necessary.	0 ~ 100
	Sharpness	Sharpness adjusts the sharpness of the monitor.	0 ~ 4
	Gamma	Select a display gamma for best picture quality.	1.8/ 2.0/ 2.2/ 2.4
	Temperature	Adjust the color temperature of the screen. If color temperature needs further adjustment, the individual RGB levels of the white point can be adjusted. Can be used only in user mode of color temperature	10000/ 9300/ 6500/ USER-RGB(0~255)
	Studio Mode	Select studio mode. The color temperature of studio mode is about 3200k	On / Off
	Hue	Adjust the hue value of the screen	0 ~ 100
	Saturation	Adjust the saturation value of the screen	0 ~ 100

### 5.2. Input Menu

- Use the Input Source menu to select between different video inputs that are be connected to the monitor.

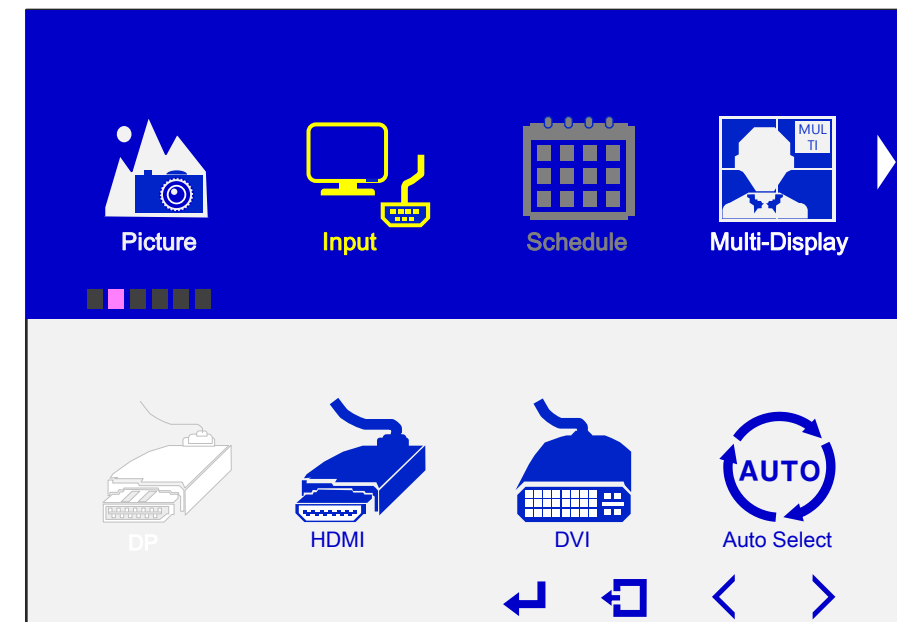

[Input Menu Table]

MENU	SUB MENU	DESCRIPTION	RANGE
Input	DP	Select DP input when you are using the DP(DisplayPort) connector.	-
	HDMI	Select the HDMI(MHL)input when you are using the HDMI connector. User to select the HDMI(MHL)input source.	-
	DVI	Select DVI input when you are using the DVI connector.	-
	AUTO INPUT	Auto Detect input signal	-

### 5.3. Schedule Menu

- Use this function to reserve the time when the monitor turned On or Off.

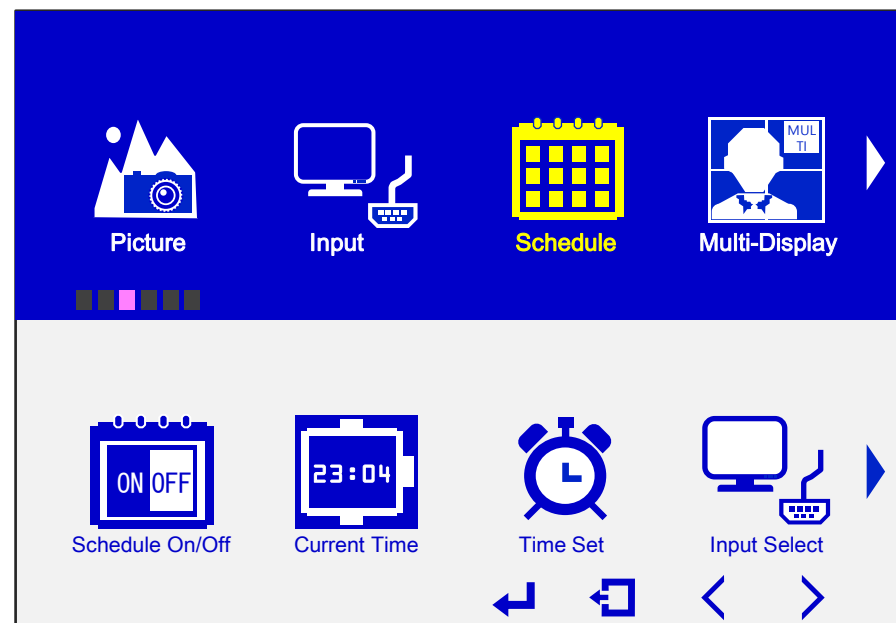

[Schedule Menu Table]

Menu	Sub menu	Description	Range
Schedule	Schedule On/Off	Activate or deactivate the Schedule function.	ON/OFF
	Current Time	Adjust the current date and time for the internal clock.	-
	Time Set	Set a schedule, Everyday/Sun/Mon/Tue/Wed/Thu/Fri/Sat. Set the time3 for the display to turn on and turn off.	-
	Input Select	Select default input source to use when the display is automatically turned on next time.	DP/HDMI/DVI/AUTO
	Reset	Schedule Settings will be restored to factory-preset data or Return to Menu	ON/OFF

※ This Function is not supported yet.

### 5.4. Multi-Display Menu

- Control multi-scaling functions in this menu.

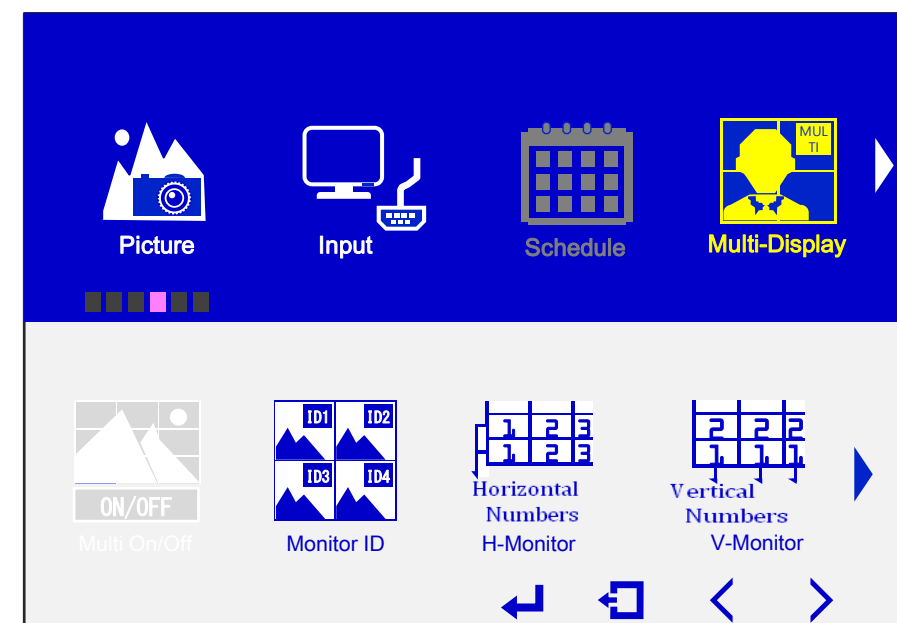

[Multi-Display Menu Table]

MENU	SUB MENU	DESCRIPTION	RANGE
Multi Display	Multi On/Off	Activate the multi-scaling screen or Deactivate.	On / Off
	Monitor ID	Assign the id to the monitor individually.	1~254
	H-Monitor	Set the number of horizontal monitor in multi-screen.	1~16
	V-Monitor	Set the number of vertical monitor in multi-screen.	1~16
	Multi Position	Set the position number of the segment image in multi screen.	1~254
	B-Comp. Set	Activate Bezel compensation.	On / Off
	B-Comp. Value	Set bezel compensation numerically.	1~30

### 5.5. Other Menu

- Reset of the OSD settings, menu time, transparency, position and rotation of the OSD can be adjusted in other menu.

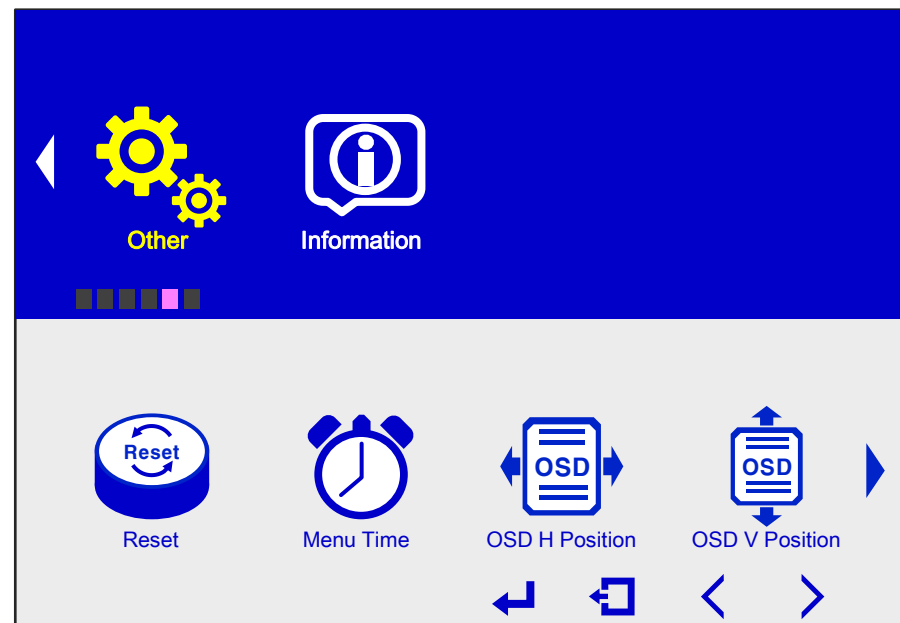

[Other Menu Table]

MENU	SUB MENU	DESCRIPTION	RANGE
OTHER	RESET	Initialize all the setting value and options.	-
	MENU TIME	OSD operation time	3 ~ 60
	OSD H POSITION	OSD horizontal position adjustment	0 ~ 100
	OSD V POSITION	OSD vertical position adjustment	0 ~ 100
	LANGUAGE	Select the language	EN/DE/FR/ES/NL/PL/RU/IT
	TRANSPARENCY	OSD transparency ratio adjustment	0 ~ 10
	OSD ROTATE	OSD rotation	0° / 90° / 270°
	FAN On/Off	Turn On/Off the fan operation	On / Off
	Model Info	View model name, IP address, Subnet Mask, Gateway	-
	LAN	Turn on or off the Lan operation	On / Off
	Auto Power	Turn on or off the Auto Power	On / Off

### 5.6. Information Menu

- The informaton of input source is shown.

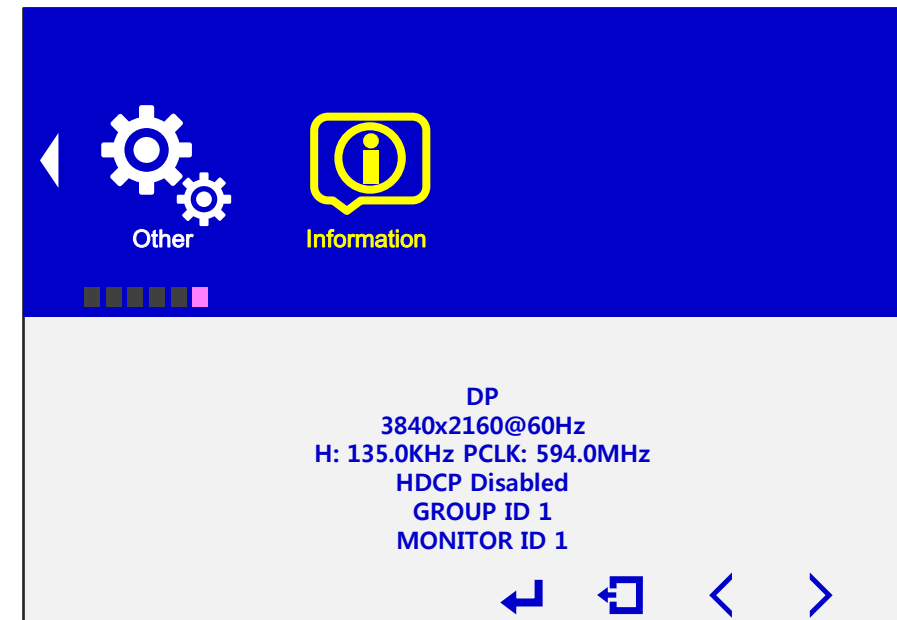

- Check it out via the info button.

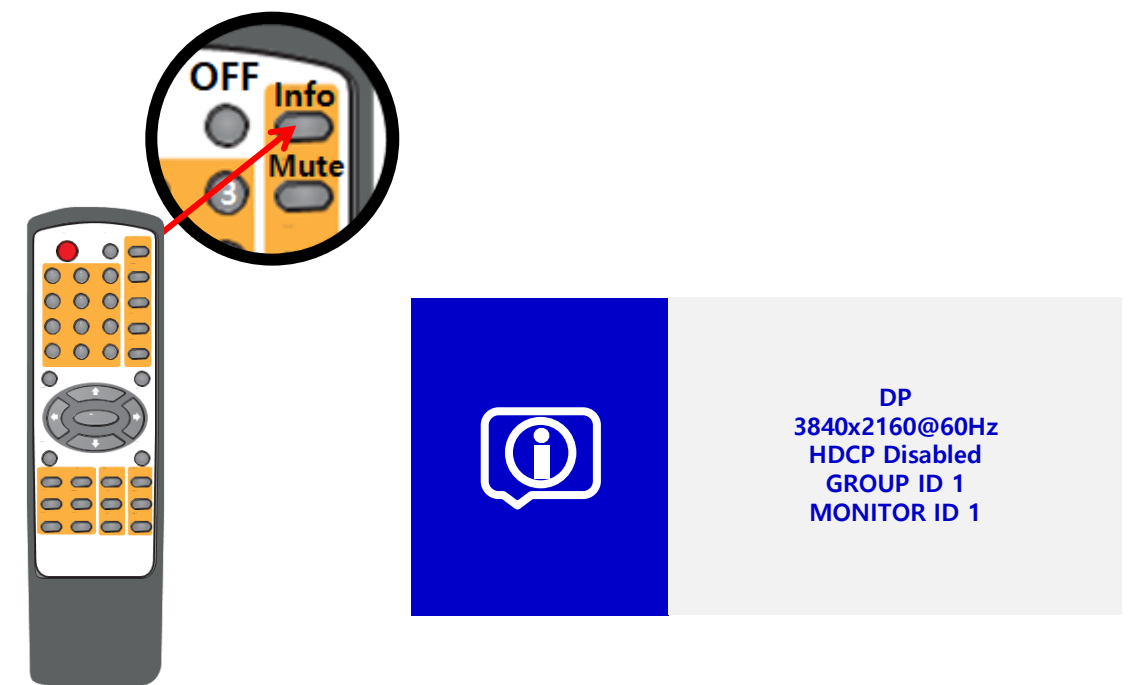

## 6. Setting and Operation of OSW

### 6.1. Installation

- Insert the Installation CD.
- You can see following installation start screen.
- Select proper version for your product and start installation
- OSW supports Window® (2000, XP, Vista, 7, 8, 10).



\* OSW Versions can be changed for function improvement without prior notice.



#### Caution for using OSW

1. Specific features can be read by clicking the left button of your mouse on the desired MLCD set from OSW. Please do not use above function together with the other functions.

### 6.2. Start OSW

- OSW is a software for controlling Orion's monitor.
- When you execute OSW (v1.0.6) for your product at the installation screen, it will create a new folder at C:\Program Files \ORION and an icon on your computer screen.
- By double clicking the ORION OSW (v1.0.6) icon, the initial screen image of OSW (v1.0.6) will be displayed as shown in the picture.

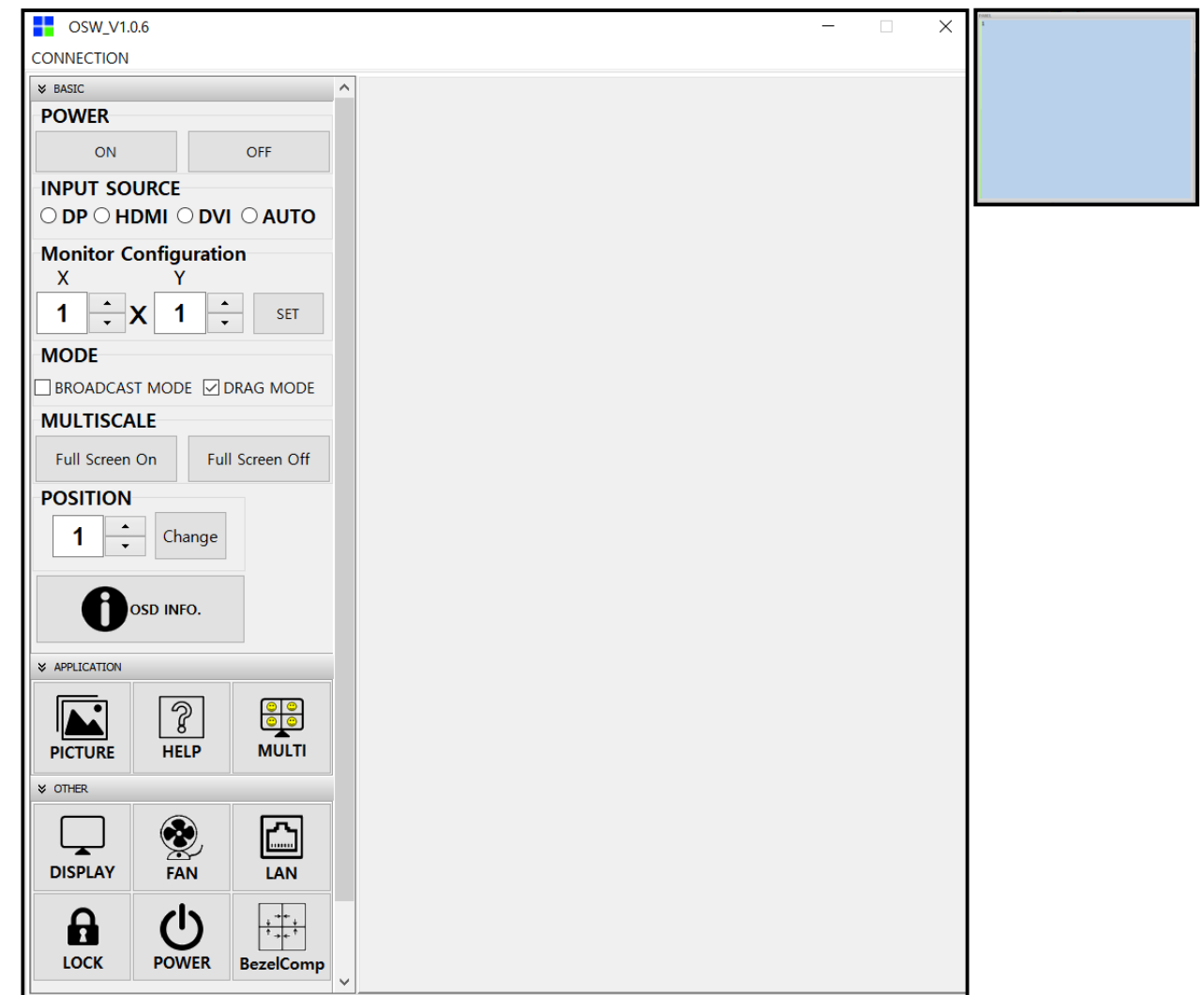

Main Image of OSW (Orion Software)

### 6.2.1 Main Menu

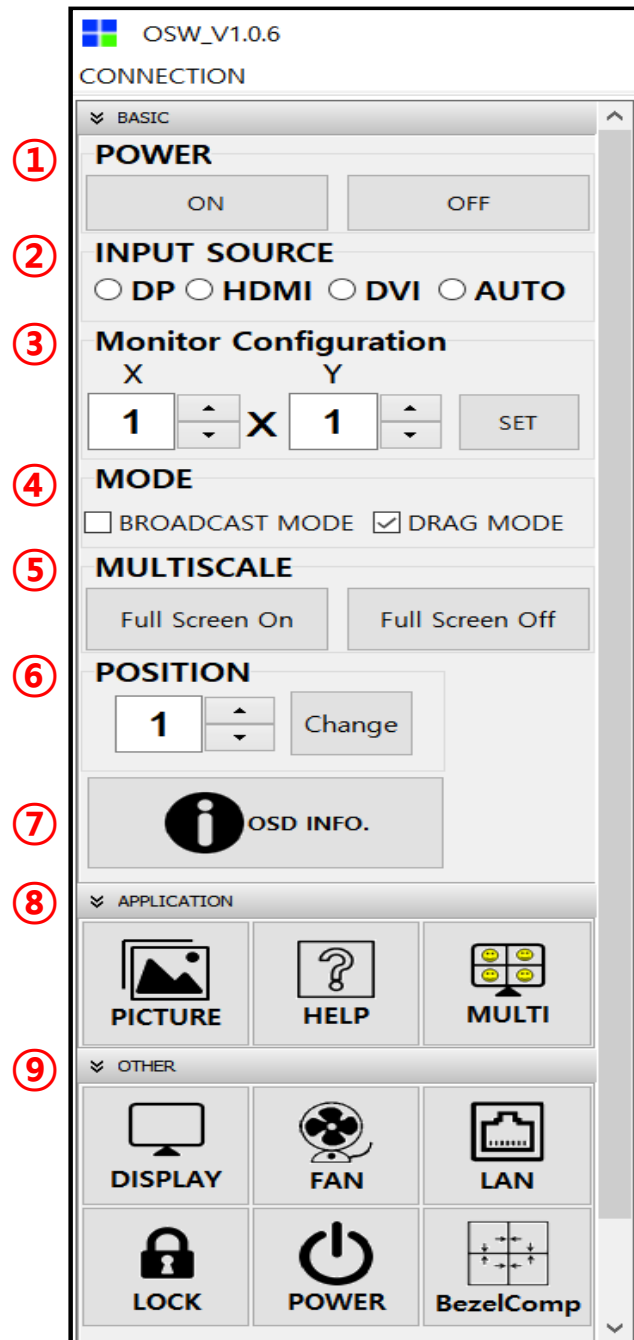

- ① **POWER**  
Power On/Off.
- ② **INPUT SOURCE**  
Input Source.(DP, HDMI, DVI, AUTO)
- ③ **MONITOR CONFIGURATION**  
Monitor Configuration X\*Y(16\*16) Set.
- ④ **MODE**  
Broadcast Mode, Drag Mode.
- ⑤ **MULTI SCALE**  
Full Screen On/Off.
- ⑥ **POSITION**  
Screen Position.
- ⑦ **OSD INFO**  
On Screen Display Information.
- ⑧ **APPLICATION**  
Picture, Help, Multi
- ⑨ **OTHER**  
Display, Fan, Lan, Lock, Power, Bezel Comp.

### 6.2.2 Multi Panel

- This is a panel for selecting monitor.
- It can help for controlling

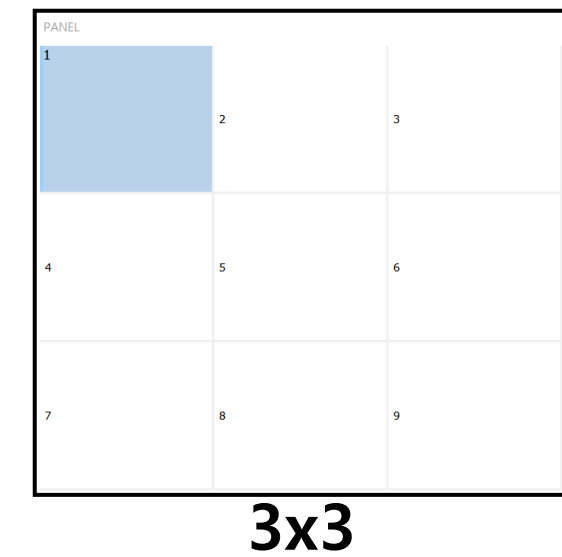
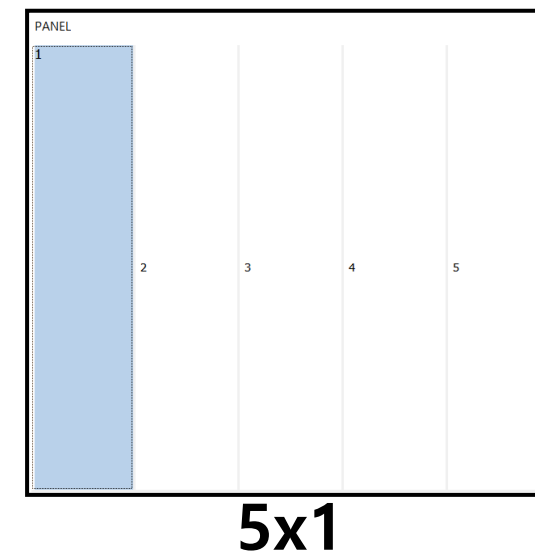
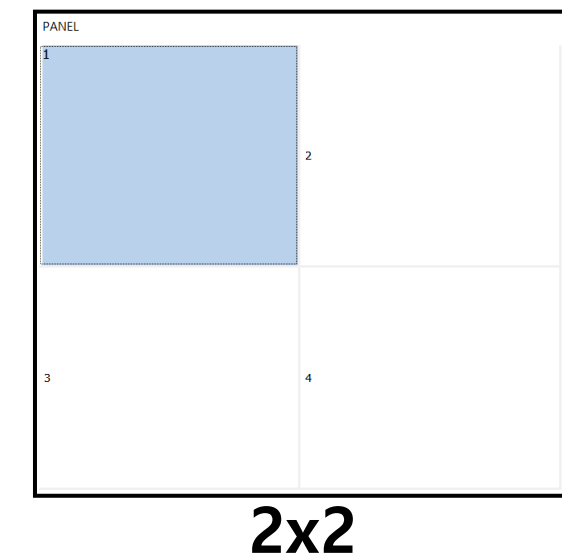
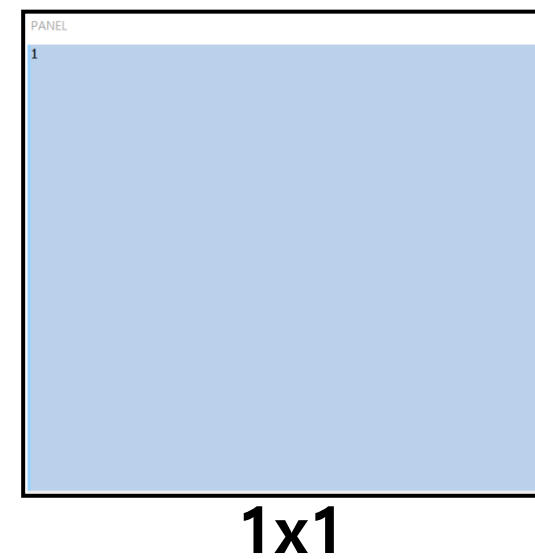

### 6.3. Communication Configuration

#### 6.3.1. COM Port For OSW

- Com Port connects or disconnects the communication between PC and MLCD.
- Connect MLCD to PC Com Port via RS-232C cable.

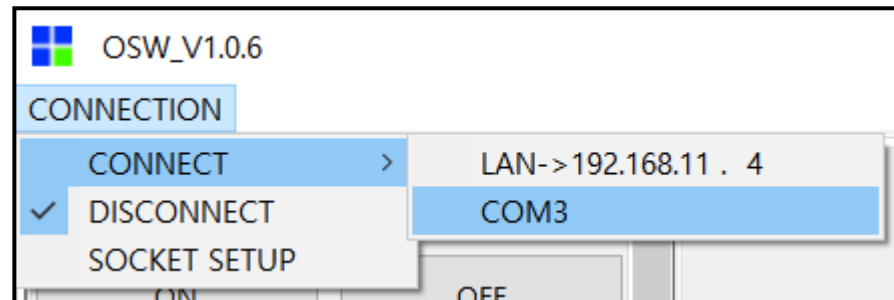

- Go to "OSW Menu → CONNECTION → CONNECT" and select the comport you want to connect.
- In order to disconnect the communication, click "DISCONNECT"..
- **When you use USB-to-RS-232C converters, you need to set Com Port again, because OSW uses one of Com Port no. 1 to 30.**  
 ※ Available Com Port on the PC is automatically recognized and displayed.

#### 6.3.2. LAN Port For OSW

- LAN Port connects or disconnects the communication between PC and MLCD.
- Connect MLCD to PC LAN Port via LAN cable.

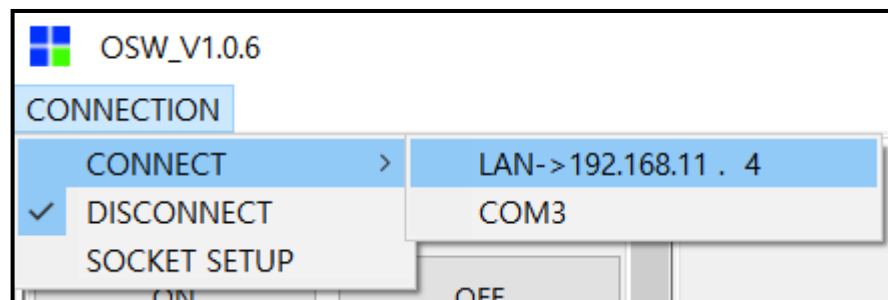

- Go to "OSW Menu → CONNECTION → CONNECT" and select the LAN port you want to connect.
- In order to disconnect the communication, click "DISCONNECT"..
- ※ Destination IP address is configured using "SOCKET SETUP" menu.
- ※ Destination IP address is IP address of the MLCD you want to connect.

#### 6.3.3. Socket Setup

1. Execute the OSW.
2. Select "OSW Menu → CONNECTION → SOCKET SETUP".

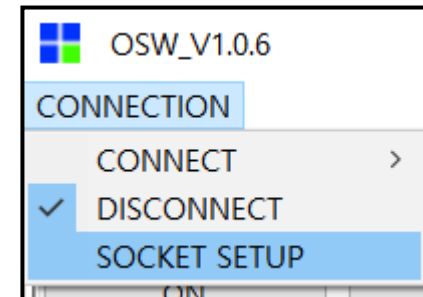

3. Type in IP Address of MLCD.
4. Click "PING TEST" to check status of communication.
5. Close the Communication setup window

#### • Socket Setup Menu Description

- **Edit Box** : Set the IP address.
- **Port Number** : Fixed as 9761.  
 \* Caution: You cannot change the port number.
- **Ping Test**: Test the IP address.

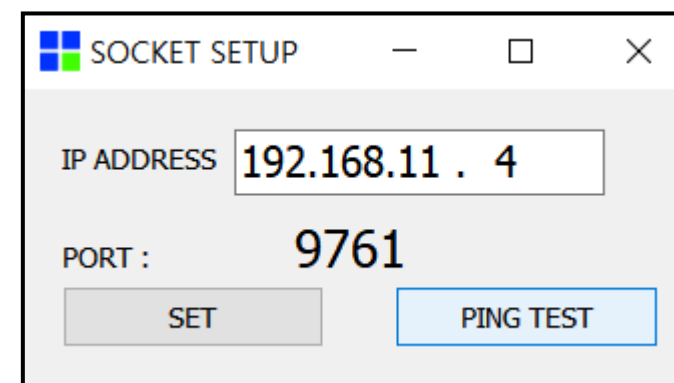

SOCKET SETUP

### 6.3.4. LAN Port For MLCD

#### 6.3.4.1 In case of connection to a LAN Hub

- This function is used to control the MLCD via LAN PORT.
- During the setting process, MLCD and control PC should be connected via RS-232C cable only. Do not connect Ethernet.
- After setting process, the control PC should be connected to one of MLCD sets with Ethernet cable only. For the connection between the MLCD sets, they should be connected with RS-232C cables.

※The Ethernet cable should be connected to RS-232C starting point

#### ■ Network IP setting for MLCD

1. Execute the OSW.
2. After Serial Connection, Turn on the MLCD.
3. Click left button of the mouse on the MLCD that you want to control on the screen configuration window.(This MLCD should be connected to LAN cable)

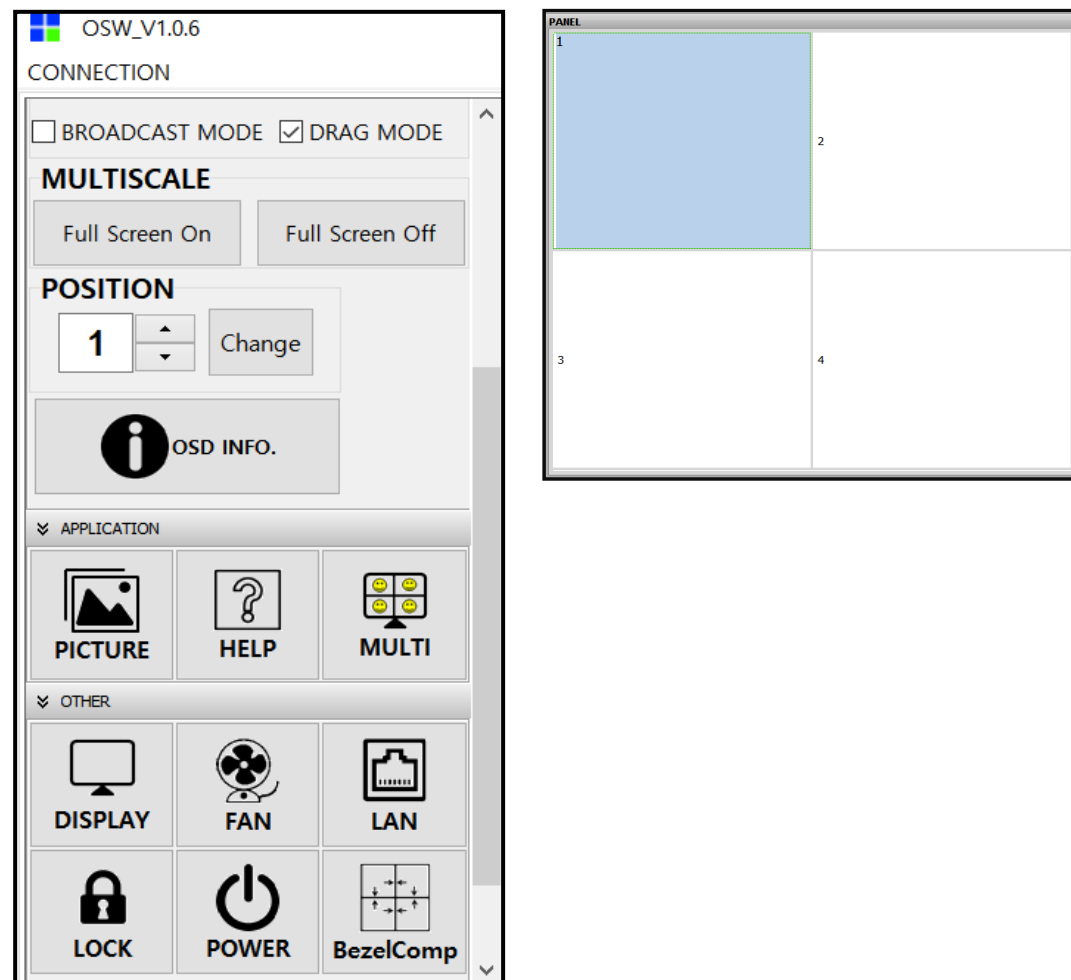

4. Click " OTHER → LAN "

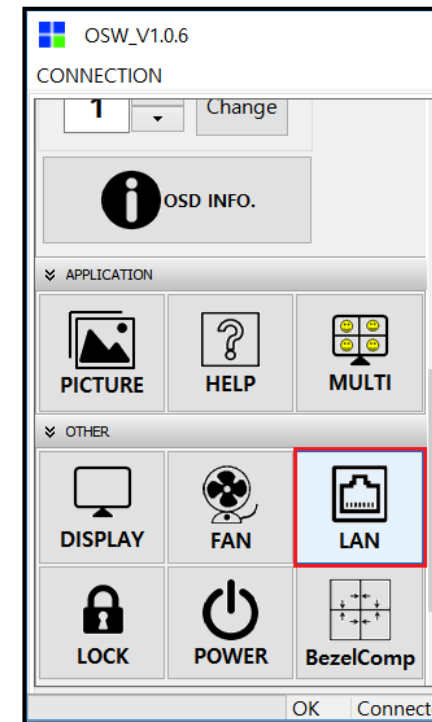

5. Type in the IP address provided by the network administrator.

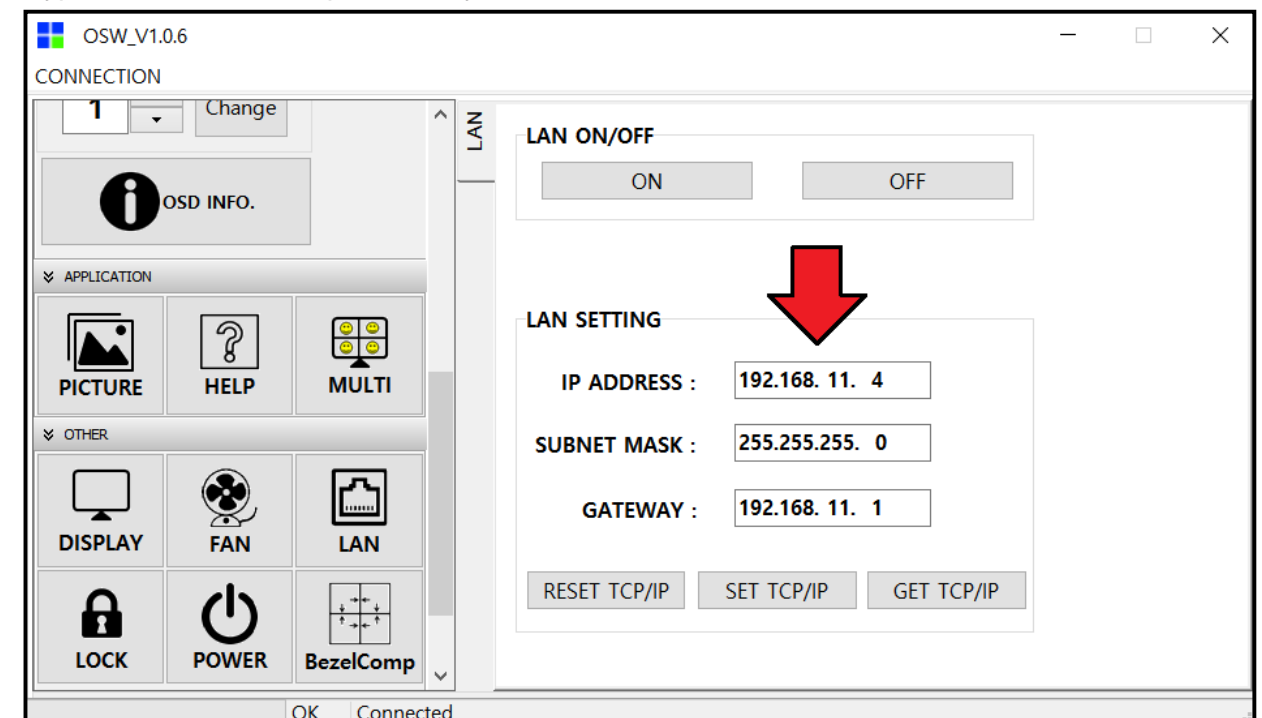



6. Save the IP address by clicking "SET TCP/IP" after type-in.

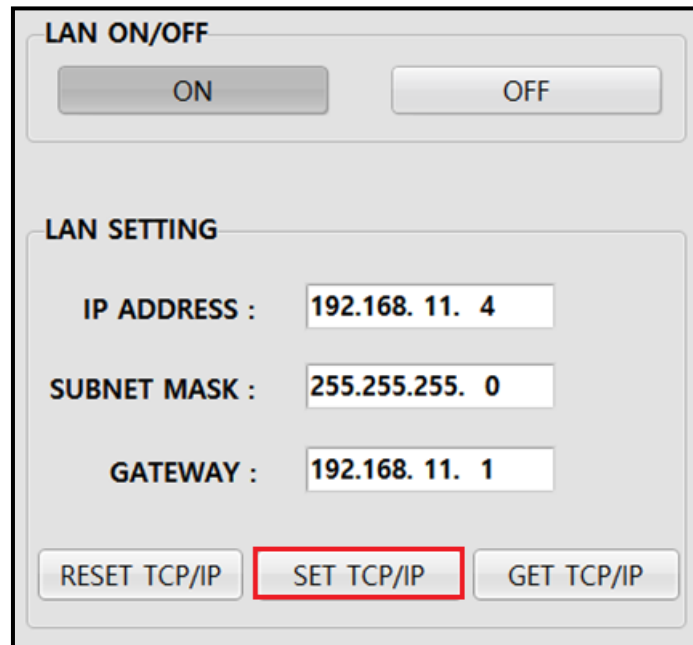

7. Click "GET TCP/IP" and check whether the IP address is correct.

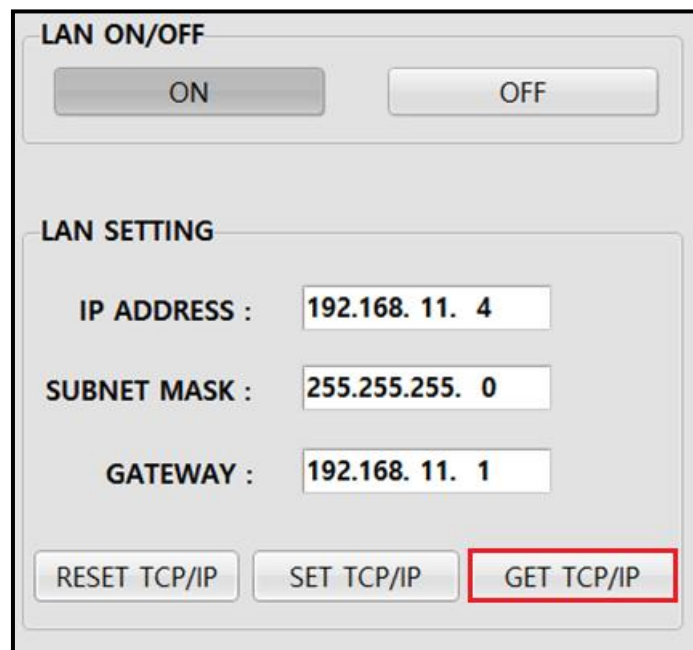

### 6.3.4.2. In case of connection to user's computer

#### ■ Check the network informations

1. Execute the OSW.
2. After Serial Connection, Turn on the MLCD.
3. Click left top of the mouse on the MLCD that you want to control on the screen configuration window.(This MLCD should be connected to LAN cable)
4. Click → OTHER → LAN
5. Click the "LAN ON" and click "GET TCP/IP" to read the initial network configuration of the MLCD.

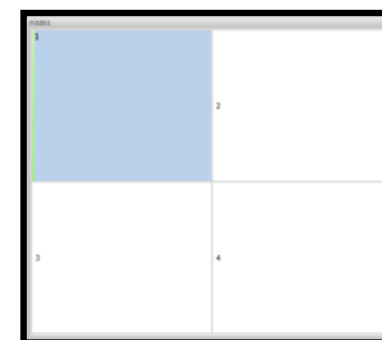
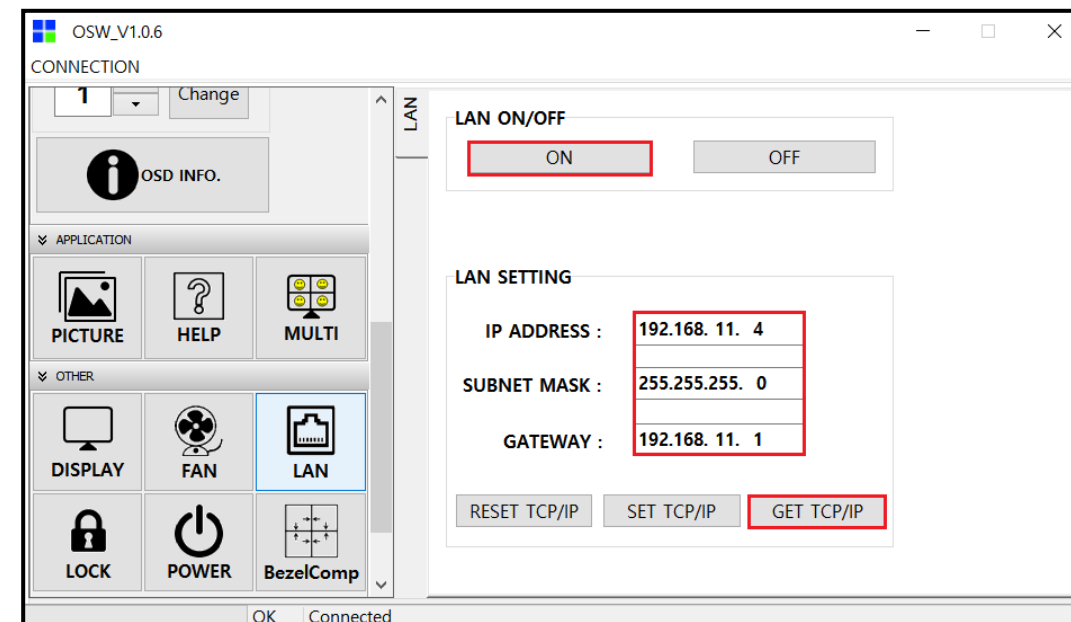

6. Input the network information of the user's PC to be identical with MLCD set. However, the final digit of the IP address must be different.

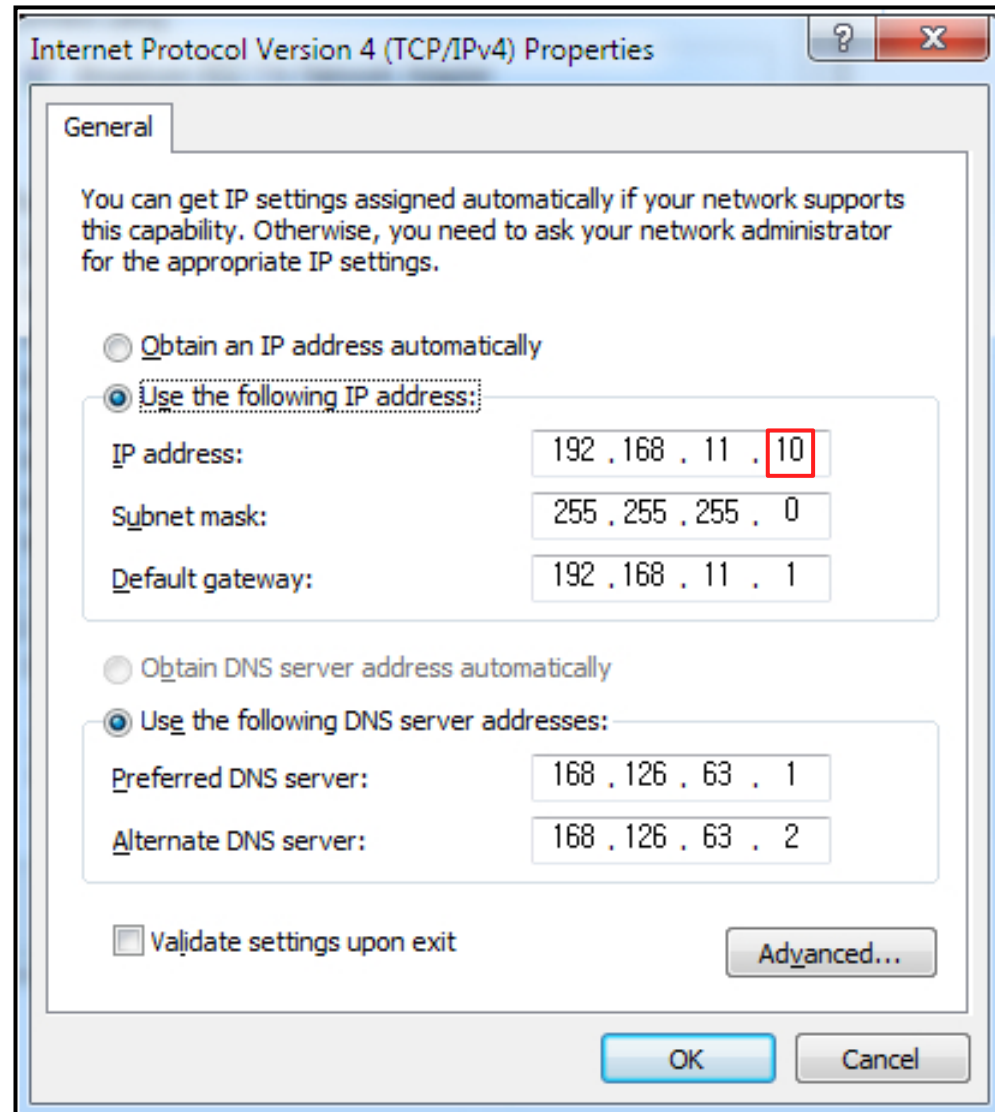

## 6.4. Screen Configuration

### ■ Input column/row number of the MLCD Matrix.

- Column/row can be selected within the range from 1 to 16. The maximum MLCD quantity of OSW control is 254 sets.
- After inputting column/row number, MLCD matrix with input source color is displayed in the "Screen Configuration" after click the button "SET"

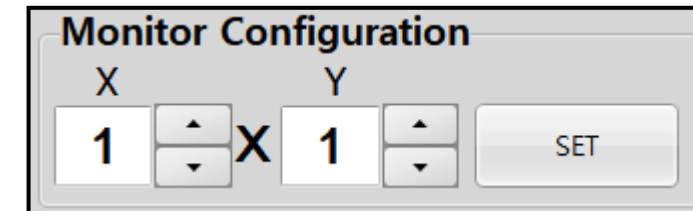

Screen Configuration Setting

### ■ BROADCAST.

- When broadcast checkbox is checked, entire command transmission method is broadcast.
- When broadcast checkbox is not checked, entire command transmission method is normal mode.
- User Transmit the Protocol command respectively to Selected MLCD Sets in normal transmission method.

※ You can't select the MLCD in screen configuration in broadcast.

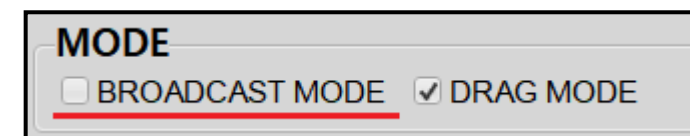

Mode Setting

### ■ DRAG MODE.

- When the Drag Mode checkbox is not checked, the screen configuration window will be clicked only one.

### 6.5. Explanation of the command transmission method.

#### ■ Normal Transmission Method.

BROADCAST MODE

: You select MLCD sets in "Screen Configuration Window" clicking the left button of the mouse. Maybe you want to select more than one MLCD set, drag the mouse. Then you can transmit the Protocol command respectively to selected MLCD Sets.

#### ■ Broadcast Transmission Method.

BROADCAST MODE

: When broadcast checkbox is checked, entire command transmission method is broadcast. You can transmit the Protocol command simultaneously to all connected MLCD sets.

※ All Protocol commands are affected by the command transmission method.

### 6.6. Basic Control

- To control basic operation in Main Screen.

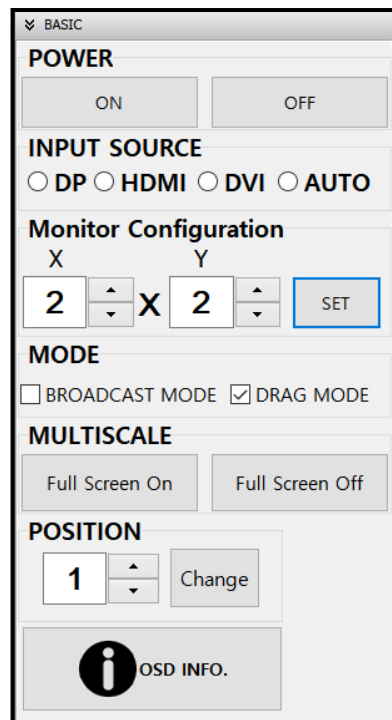

**Caution**

- Please wait for at least 10 seconds before executing "Power On" command after the first AC power connection. If not, it may cause abnormal behavior.
- Please disconnect AC power and reconnect in case of abnormal behavior.

- POWER** : " POWER ON/OFF " button is to control power of selected MLCD Sets.

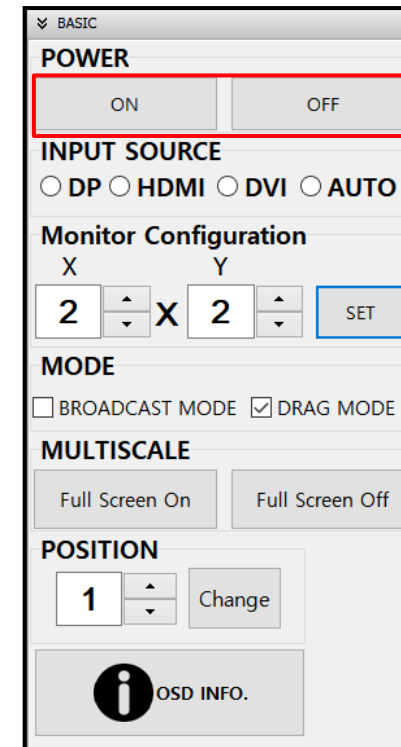

- MULTISCALE** : " Full Screen On " button is to make multiscaling screen. " Full Screen Off " button is to make individual screen.

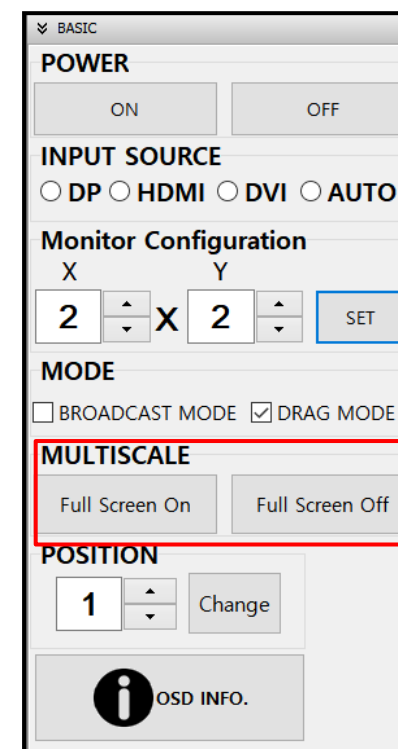

- Drag the panel -> Click the "Full Screen On" button

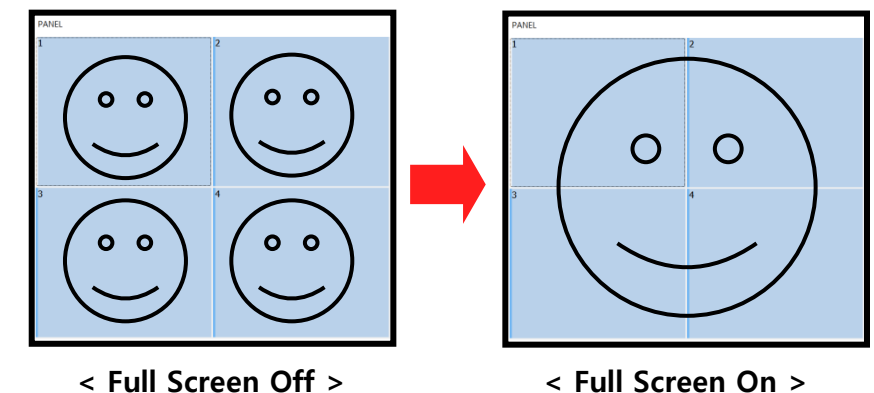

- **INPUT SOURCE** : To select one of input sources from DP, HDMI, DVI, AUTO Port.

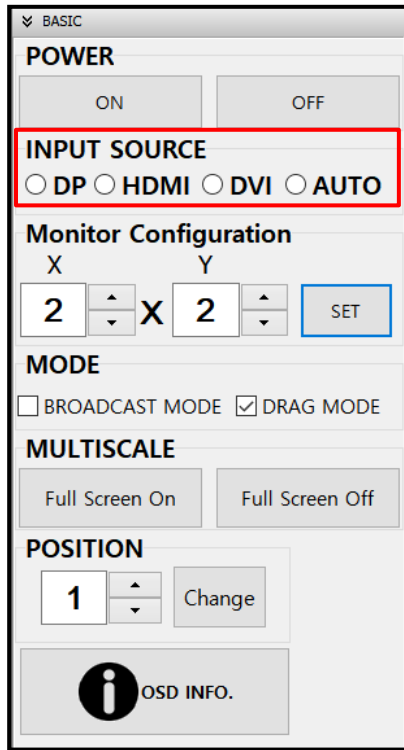

- **INFO.** : "INFO." button is to display the resolution of the input source and the signal. It is displayed at the center of the screen.

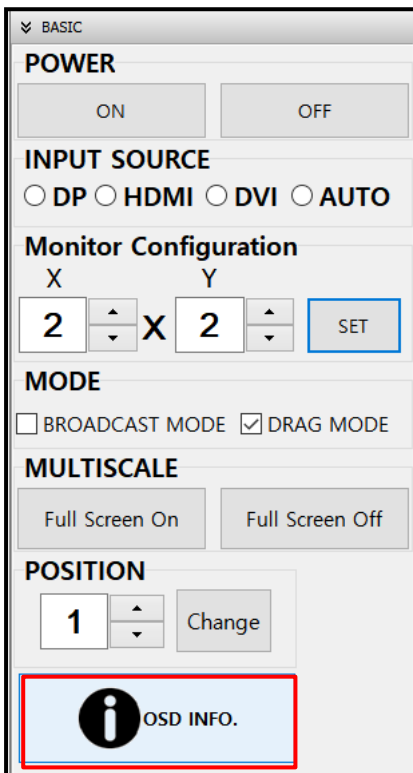

- **POSITION** : To change monitor position.(only one monitor)

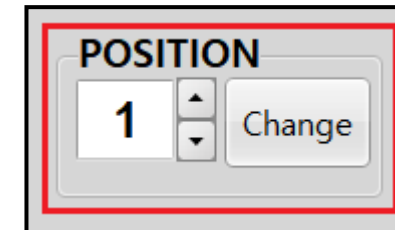

1. Select → Screen configuration window



2. Click the "Change" button after change the position number

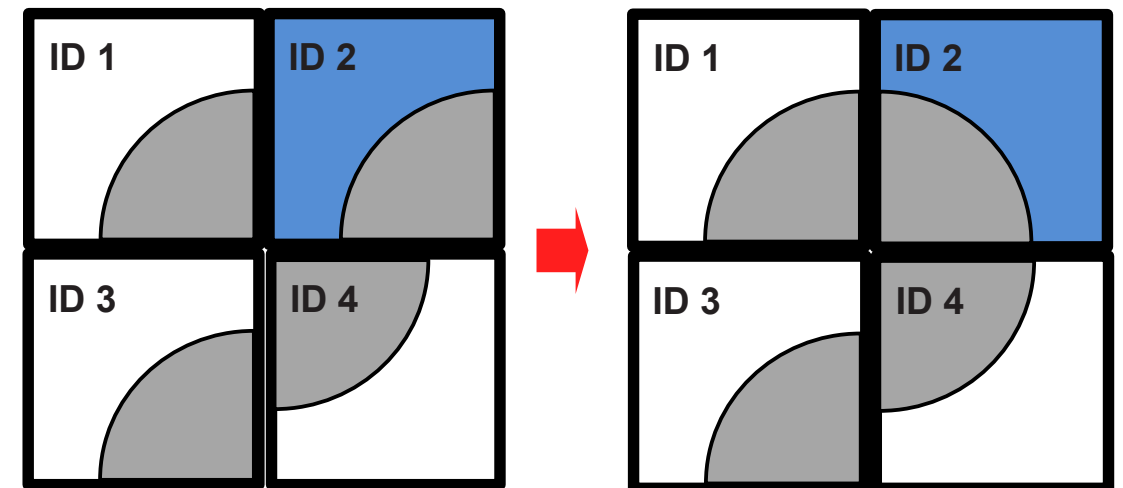
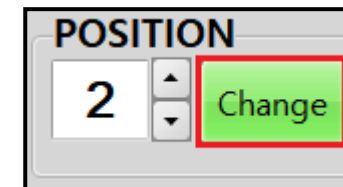

3. Select → Screen configuration window



4. Click the "Change" button after change the position number

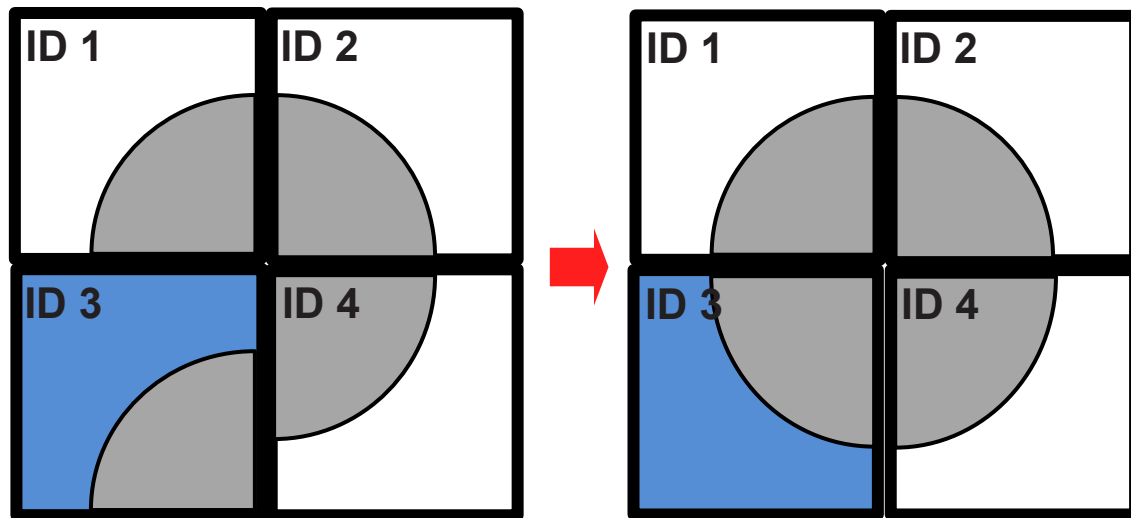
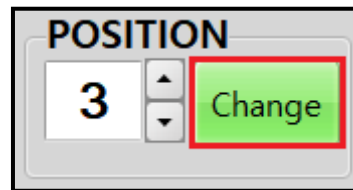

## 6.7. Control

### 6.7.1. Power ON Control

- Go to "OTHER → POWER" to control power related operation.

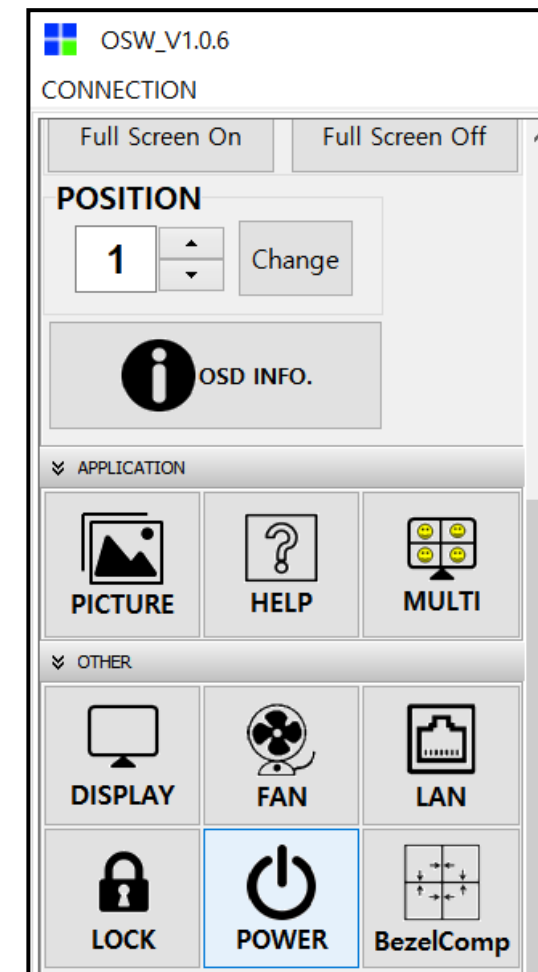

- **AUTO POWER** : Automatic power on by AC power connection.

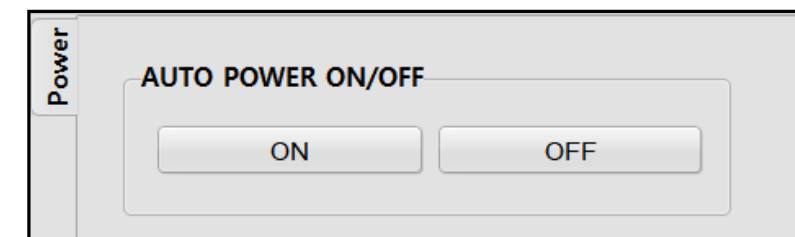

### 6.7.2. Display Control

- Go to "OTHER → DISPLAY" to control display related operation.

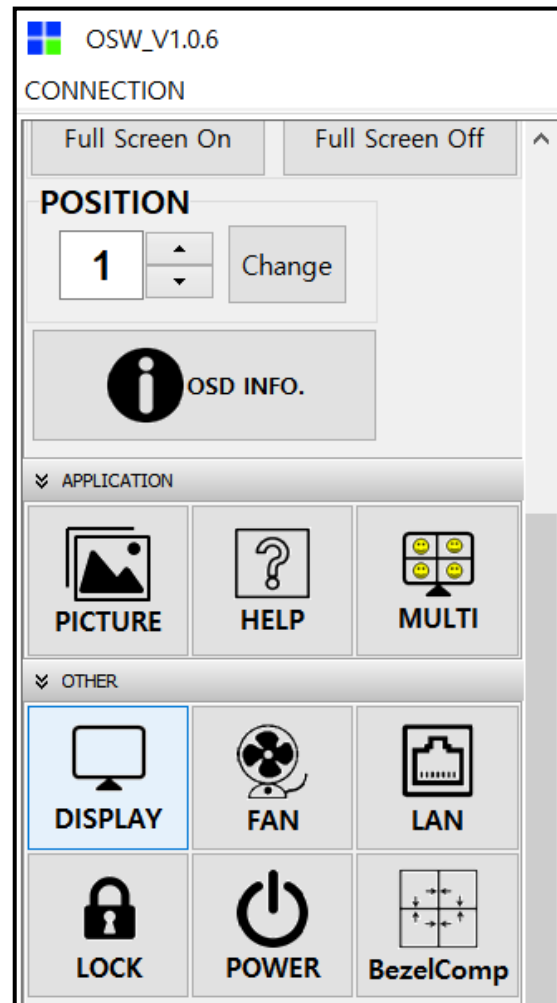

- **DISPLAY RESET** : Reset of setting value to default.



### 6.7.3. Picture Control

- To use Picture Control, go to "APPLICATION → PICTURE".

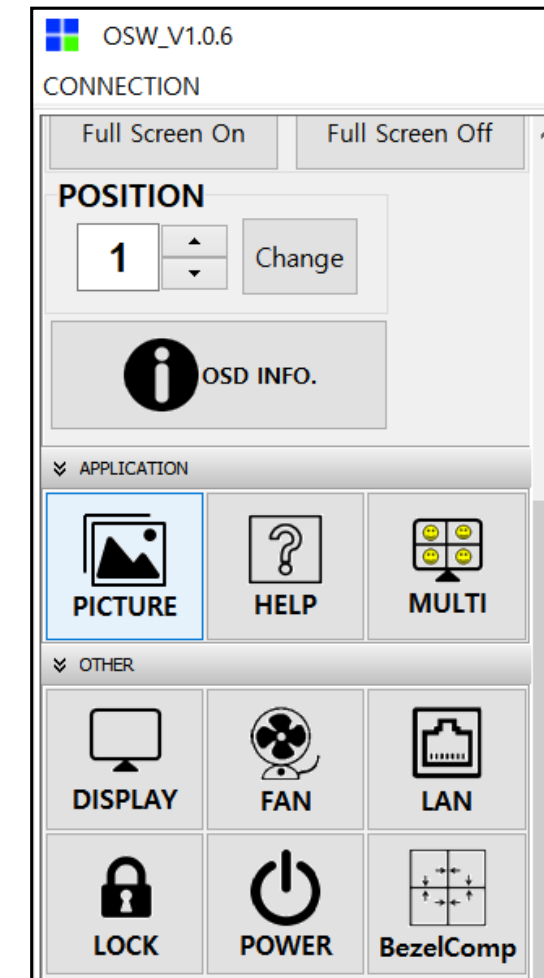

- **BRIGHTNESS** : Brightness adjusts the brightness of the monitor. (0~100)
- **CONTRAST** : Contrast adjusts the difference between darkness and lightness on the monitor. (0~100)
- **SHARPNESS** : Sharpness adjusts sharpness of the monitor. (0~4)
- **HUE** : Adjust the hue value of the screen. (0~100)
- **SATURATION** : Adjust the saturation value of the screen. (0~100)
- **BACKLIGHT** : Adjust the backlight value of the screen.(0~100)
- **GAMMA** : Select a display gamma for best picture quality.(1.8/ 2.0/ 2.2/ 2.4)
- **COLOR TEMP** : Color temperature of the screen - 10000K, 9300K, 6500K, STUDIO, USER.

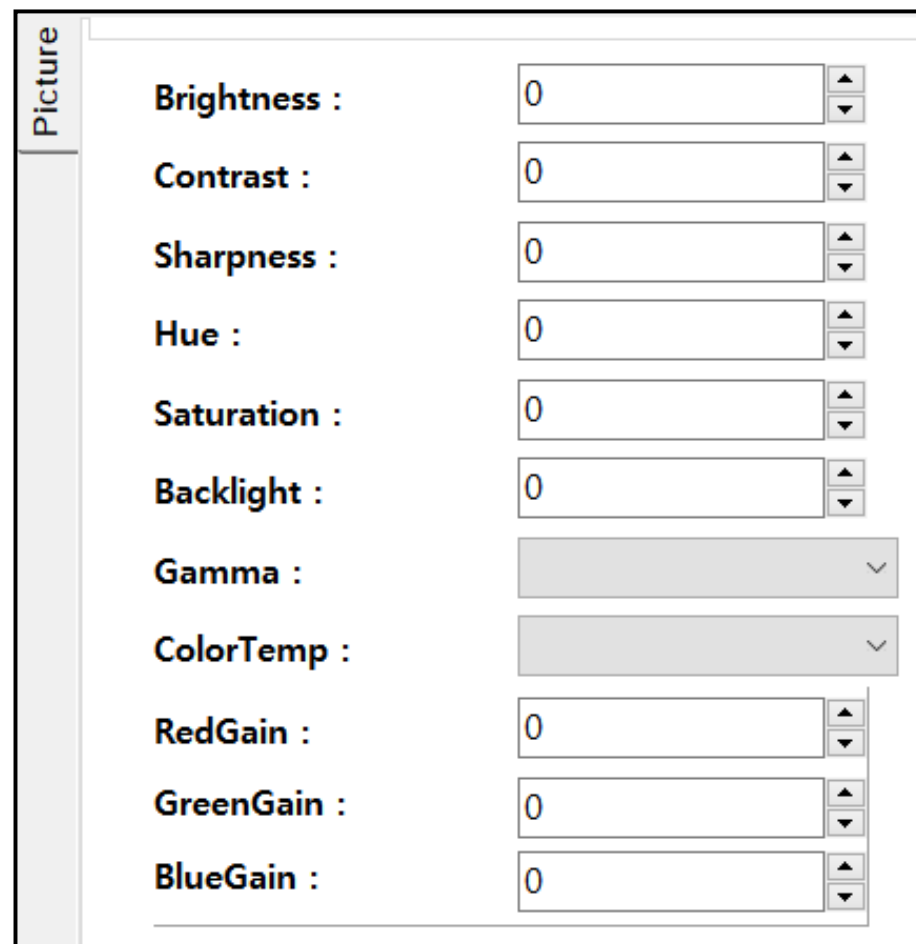

### 6.7.4. FAN Control

- Go to " OTHER → FAN " to control fan related operation.

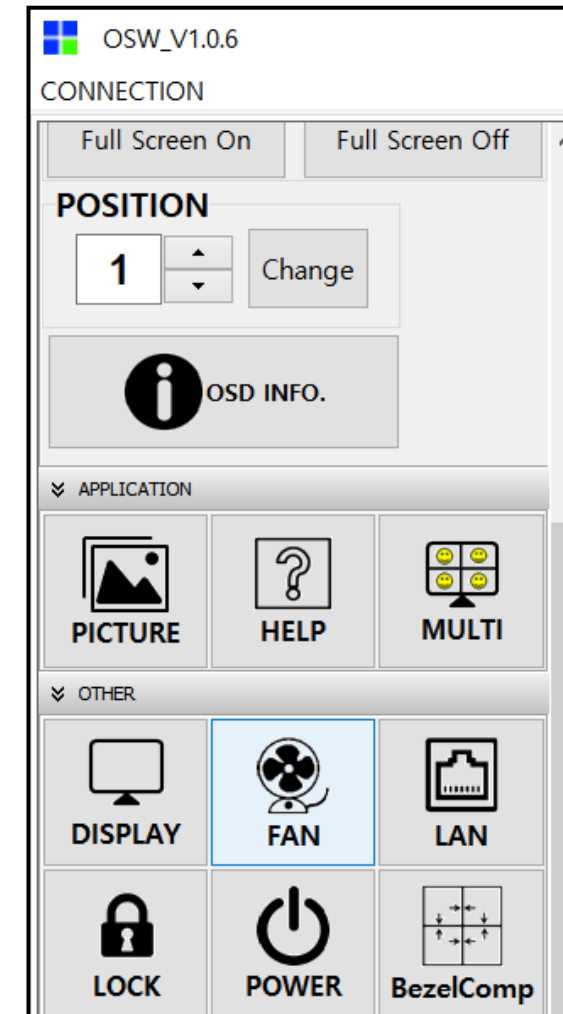

- **FAN** : FAN On/Off

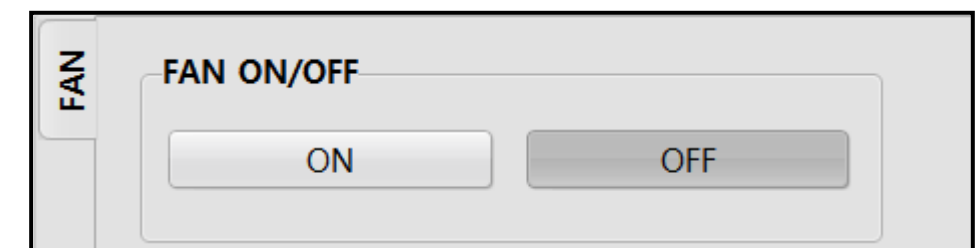

### 6.7.5. LOCK Control

- Go to " OTHER → LOCK " to control lock operation.

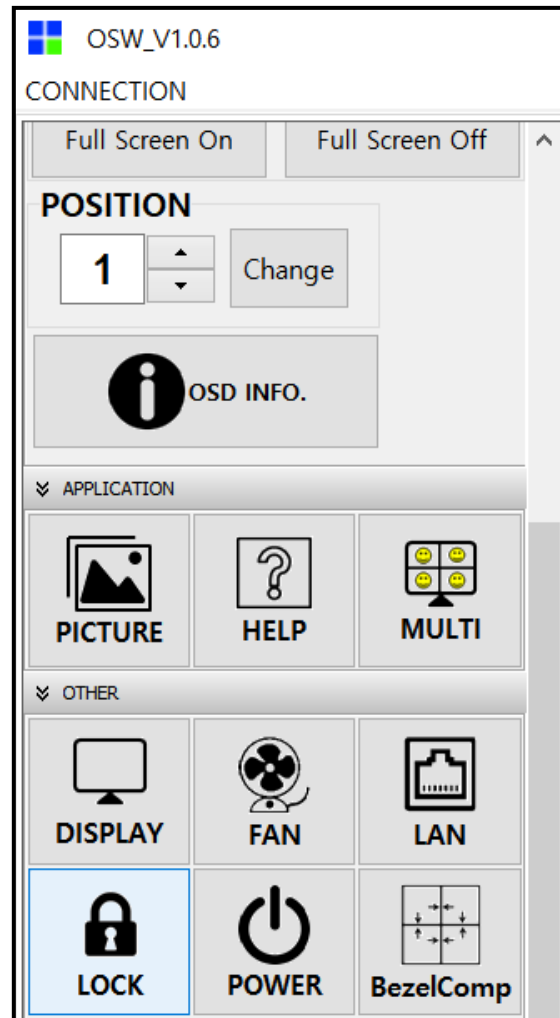

### 6.7.6 Help

- Go to " APPLICATION → HELP " to check model information

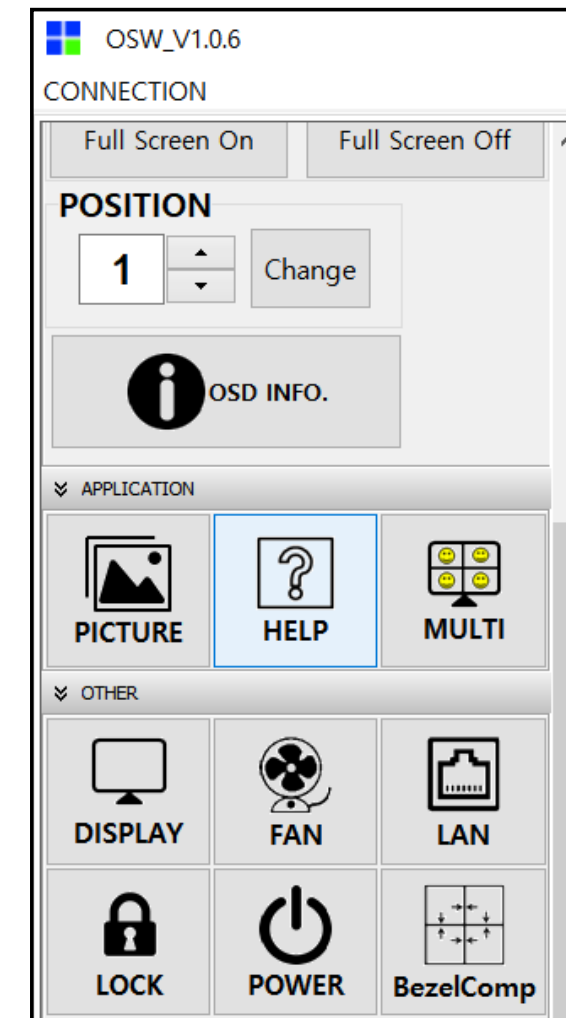

- IR Lock : IR (Remote Controller) Lock On or Off





- **Model Info** : Click → “ **GET** ” button to check model information



- **About OSW** : Click → “ **About OSW** ” tab to check osw information

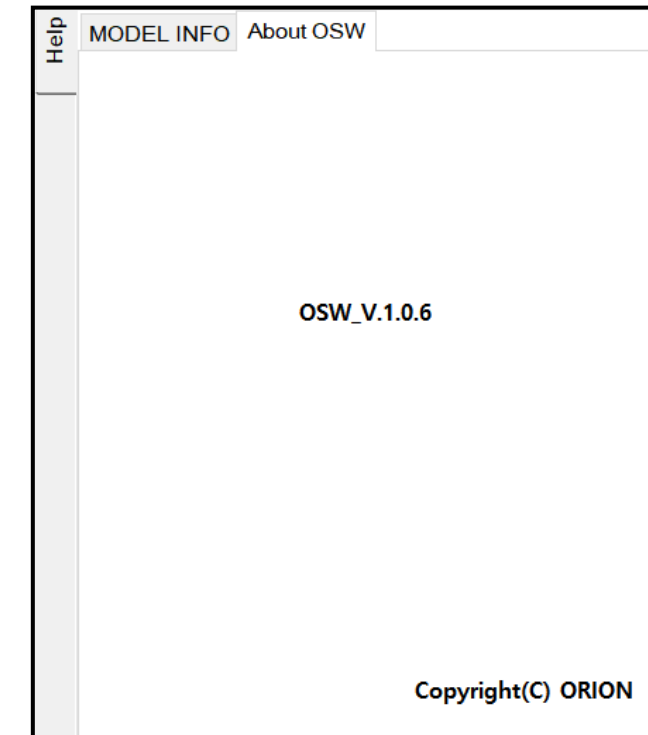

- **TAG NAME SET**

1. Select the panel



2. Type in edit box and click the set button.

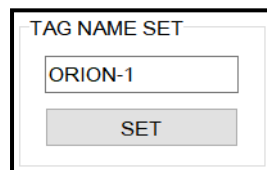

3. Check the Tag name

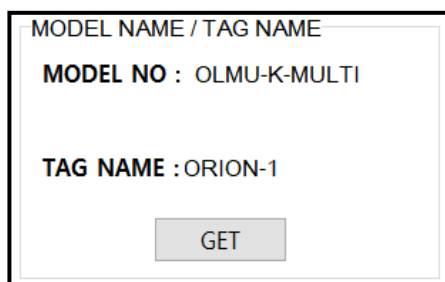

### 6.7.7. Bezel Control

- Go to " OTHER → Bezel Comp " to control Bezel Compensation

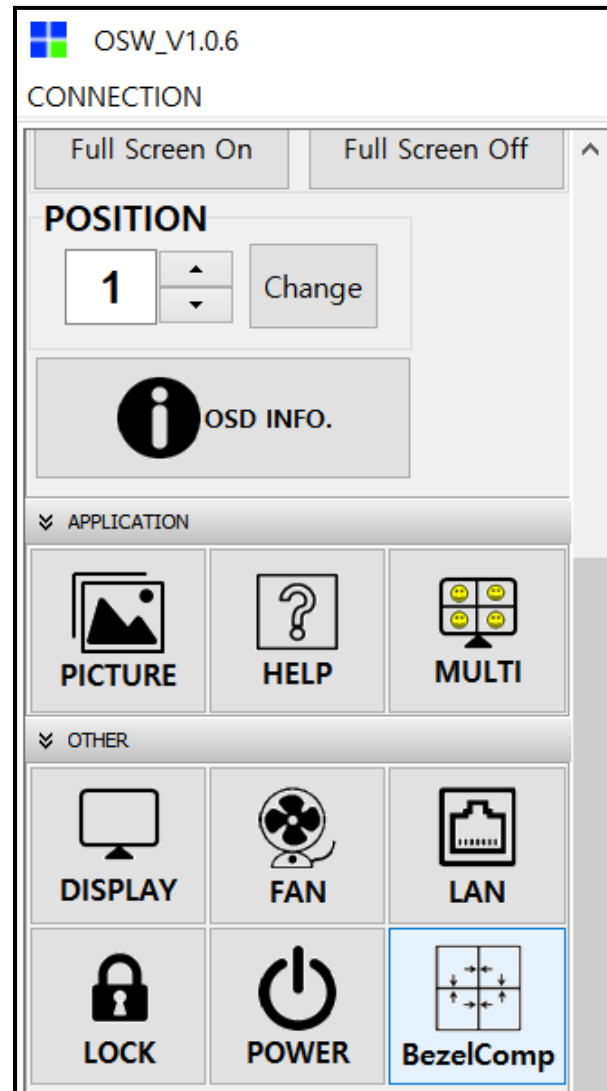

- **Bezel Compensation** : Bezel Compensation On/Off
- **Bezel Comp Value** : Compensating the frame width.(0~30)

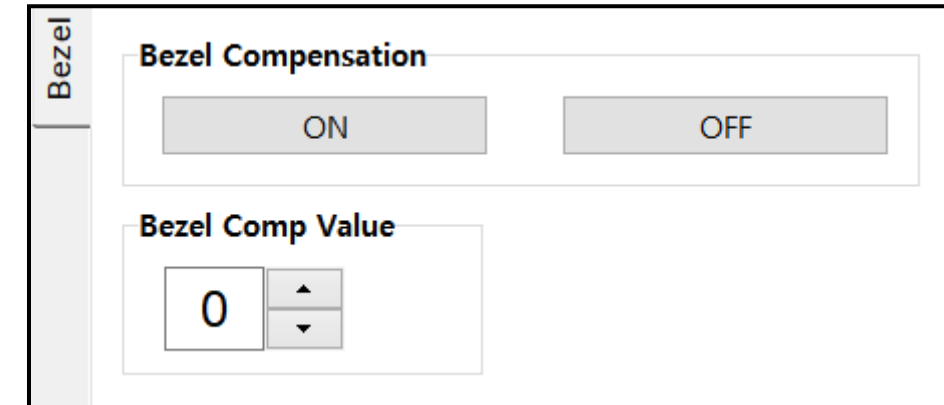

# 7. PROTOCOL

## Introduction

- This document contains the communication PROTOCOL between LCD and its control devices for better use.
- It focuses on the brief functional explanation and communication protocol without detailed technical matters.

### 7.1. Communication Setting

ITEM	SPECIFICATION			
TRANSMISSION & RECEPTION TYPE	ASYNCHRONOUS SERIAL COMMUNICATION			
CONNECTION TYPE	DAISY CHAIN			
BAUD RATE	57600 bps			
DATA BITS	8			
PARITY	NONE			
STOP BITS	1			
FLOW CONTROL	NONE			
CABLE & PIN ASSIGN	9PIN D-SUB, MALE / FEMALE STRAIT TYPE			
	PC	PIN NO.	PIN NO.	MONITOR
	RX DATA	2	2	TX DATA
	TX DATA	3	3	RX DATA
	GND	5	5	GND

### 7.2. Protocol Format

#### 2.1 Send Protocol Format

STX	COMMAND		LEN	DATA						EXT
STX	MCMD	SCMD	LEN	GID	MID1	MID2	D1	...	Dn	EXT

#### 2.2 Receive Protocol Format

STX	COMMAND		LEN	DATA						CS	EXT
STX	MCMD	SCMD	LEN	GID	MID1	MID2	D1	...	Dn	CS	EXT

\* STX - 0x02, EXT - 0x03

#### 2.3 Description of Protocol Format

ITEM	DESCRIPTION	VALUE	SIZE	REMARK
STX	START OF CODE	0x02	1 BYTE	
MCMD	MAIN COMMAND	VARIABLE	1 BYTE	
SCMD	SUB COMMAND	VARIABLE	1 BYTE	
LEN	LENGTH OF ID & DATA	VARIABLE	1 BYTE	
GID	GROUP ID	VARIABLE	1 BYTE	ID = 0 : ALL MONITOR(BROADCAST)
MID1	MONITOR ID (MSB)	VARIABLE	1 BYTE	
MID2	MONITOR ID (LSB)	VARIABLE	1 BYTE	
D1	FIRST DATA	VARIABLE	1 BYTE	DATA : n BYTE
Dn	nTH DATA	VARIABLE	1 BYTE	
CS	CHECKSUM	VARIABLE	1 BYTE	SUM = "FF"
EXT	END OF CODE	0x03	1 BYTE	

## 7.3. Command

### 3.1 Power Control Command and Data

FUNCTION	MCMD	SCMD	DATA	REMARK
POWER ON/OFF	0x0100		D1 : 0x01-ON, 0x00-OFF	
AUTO POWER ON ON/OFF	0x0110		D1 : 0x01-ON, <b>0x00-OFF</b>	
DIALOG BOX OPEN (AUTO POWER)	0x01F0		-	READ ONLY
DIALOG BOX OPEN (AUTO POWER)	0x01F0		D1 : 0x01-ON, <b>0x00-OFF</b>	RECEIVE ONLY

### 3.2 Display Control Command and Data

FUNCTION	MCMD	SCMD	DATA	REMARK
INPUT SOURCE	0x0210		D1 : 0x30- <b>DP</b> , 0x20-HDMI, 0x10-DVI, 0x80-AUTO	
DIALOG BOX OPEN	0x02F0		-	READ ONLY
DIALOG BOX OPEN (MONITOR DATA)	0x02F0		D1 : 0x00 (FIXED, NOT USED) D2 : POWER ON INPUT	RECEIVE ONLY
RESET (W/ DEFAULT DATA)	0x02FE		D3 : ROTATE	WRITE ONLY

### 3.3 Picture Control Command and Data

FUNCTION	MCMD	SCMD	DATA	REMARK
BRIGHTNESS	0x0300		D1 : 0 ~ 100 ( <b>DEFAULT 50</b> )	
CONTRAST	0x0301		D1 : 0 ~ 100 ( <b>DEFAULT 50</b> )	
SHARPNESS	0x0302		D1 : 0 ~ 4 ( <b>DEFAULT 2</b> )	
BACKLIGHT	0x0310		D1 : 0 ~ 100 ( <b>DEFAULT 90</b> )	
	0x0320		D1 : <b>0x00-OFF</b> , 0x01-1.8, 0x02-2.0 0x03-2.2, 0x04-2.4	
COLOR TEMPERATURE	0x0321		D1 : 0x00-USER, 0x03-STUDIO, 0x41-6500, <b>0x5D-9300</b> , 0x64-10000	
USER RED/GREEN/BLUE	0x0322		D1 : 0x00-RED, 0x02-GREEN, 0x03-BLUE D2 : 0 ~ 255 ( <b>DEFAULT 127</b> )	
	0x0323		D1 : 0 ~ 100 ( <b>DEFAULT 50</b> )	
SATURATION	0x0324		D1 : 0 ~ 100 ( <b>DEFAULT 50</b> )	

DIALOG BOX OPEN	0x03F0	-	READ ONLY
DIALOG BOX OPEN (W/ MONITOR DATA)	0x03F0	D1 : BRIGHTNESS D2 : CONTRAST D3 : SHARPNESS	RECEIVE ONLY
RESET (W/ DEFAULT DATA)	0x03FE	D4 : BACKLIGHT D5 : GAMMA D6 : COLOR TEMPERATURE D7 : USER COLOR TEMPERATURE RED D8 : USER COLOR TEMPERATURE GREEN D9 : USER COLOR TEMPERATURE BLUE D10 : HUE D11 : SATURATION	WRITE ONLY

### 3.4 Multi Display Control Command and Data

FUNCTION	MCMD	SCMD	DATA	REMARK
NEW ID SET	0x0600		D1 : NEW GROUP ID NO. D2 : NEW MONITOR ID NO. (MID1) D3 : NEW MONITOR ID NO. (MID2)	WRITE ONLY
AUTO ID	0x0601		-	WRITE ONLY
MULTI SCALE	0x0610		D1 : TOTAL COLUMN NO. D2 : TOTAL ROW NO. D3 : GROUP ID NO. D4 : MONITOR ID NO. (MSB) D5 : MONITOR ID NO. (LSB)	
BEZEL COMP. ON/OFF	0x0620		D1 : 0x01-ON, <b>0x00-OFF</b>	
BEZEL COMP. VALUE	0x0621		D1 : 0 ~ 30 ( <b>DEFAULT 0</b> )	
DIALOG BOX OPEN	0x06F0		-	READ ONLY
DIALOG BOX OPEN (W/ MONITOR DATA)	0x06F0		D1 : BEZEL COMP. ON/OFF D2 : BEZEL COMP. VALUE	RECEIVE ONLY
RESET (W/ DEFAULT DATA)	0x06FE		D3 : POWER ON DELAY	WRITE ONLY

## 3.5 OSD Control Command and Data

FUNCTION	MCMD	SCMD	DATA	REMARK
INFORMATION OSD ON	0x0710	-		WRITE ONLY

## 3.6 E.T.C Control Command and Data

FUNCTION	MCMD	SCMD	DATA	REMARK
FAN ON/OFF	0x07A0		D1 : <b>0x01-ON</b> , 0x00-OFF	
IR LOCK	0x0800		D1 : 0x01-ON, <b>0x00-OFF</b>	
DIALOG BOX OPEN	0x08F1		-	READ ONLY
DIALOG BOX OPEN (W/ MONITOR DATA)	0x08F1		D1-FAN ON/OFF, D2-IR LOCK	RECEIVE ONLY

## 3.7 LAN Configuration Command and Data

FUNCTION	MCMD	SCMD	DATA	REMARK
LAN ON/OFF	0x0750		D1 : 0x01-ON, <b>0x00-OFF</b>	
GET TCP/IP	0x0760		D1~D4 : IP ADDRESS D5~D8 : SUBNET MASK D9~D12 : GATEWAY D13~D17 : DNS PORT NUMBER	READ ONLY
SET TCP/IP	0x0761		D1~D4 : IP ADDRESS D5~D8 : SUBNET MASK D9~D12 : GATEWAY	
RESET TCP/IP	0x07FE		D1~D4 : IP ADDRESS ( <b>192.168.0.2</b> ) D5~D8 : SUBNET MASK ( <b>255.255.255.0</b> ) D9~D12 : GATEWAY ( <b>192.168.0.1</b> )	
DIALOG BOX OPEN	0x07F0		-	READ ONLY
DIALOG BOX OPEN (W/ MONITOR DATA)	0x07F0		D1-LAN ON/OFF D2~D5 : IP ADDRESS D6~D9 : SUBNET MASK D10~D13 : GATEWAY D14~D18 : DNS PORT NUMBER	RECEIVE ONLY

## 3.8 Model Information Command and Data

FUNCTION	MCMD	SCMD	DATA	REMARK
SET TAG NAME	0x0031		D1~D16 : TAG NAME	
DIALOG BOX OPEN	0xA0F0		-	READ ONLY
DIALOG BOX OPEN (W/ MONITOR DATA)	0xA0F0		D1~D16 : MODEL NUMBER D17~D32 : TAG NAME	RECEIVE ONLY
	0xA0F1		D1~D16 : FIRMWARE VERSION D17~D19 : MAC ADDRESS	RECEIVE ONLY

## 3.9 Monitor Status Command and Data

FUNCTION	MCMD	SCMD	DATA	REMARK
DIALOG BOX OPEN	0xA1F0		-	READ ONLY
DIALOG BOX OPEN (W/ MONITOR DATA)	0xA1F0		D1 : POWER STAUTS (0x01-ON, 0x00-OFF) D2 : AUTO POWER ON (0x01-ON, 0x00-OFF) D3 : GROUP ID (1 ~ 5) D4 : MONITOR ID (MSB, 0x00 FIXED) D5 : MONITOR ID (LSB, 0~254) D6 : INPUT SOURCE (0x30-DP, 0x20-HDMI, 0x10-DVI, 0x80-AUTO) D7 : RESOLUTION	RECEIVE ONLY

## 8. Before calling for service

- Before calling for any repair, check the following and then refer to a near A/S center.

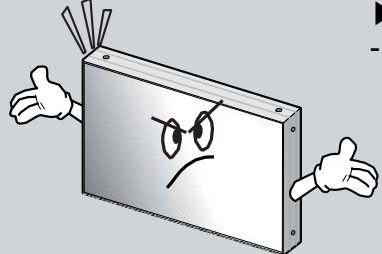

► "Tick" sound from the main body.

- If there is no problem with the screen or sound, the "tick" sound is likely to result from the cabinet lightly shrinking with the change of room temperature. The sound does not affect product's performance. ORION Homepage Log on

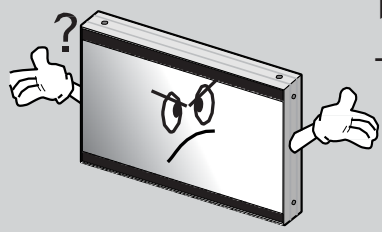

► No image at upper and lower part of the screen.

- As for a screen which is over 16:9 in width (such as cinema-sized one), no image may be displayed at upper and bottom part of the screen.

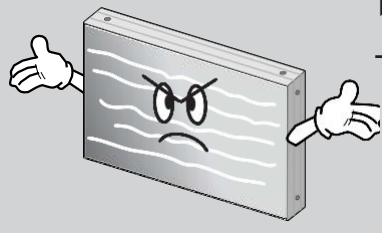

► Speckles or white lines on the screen

- Check whether the problem is caused by vehicle, streetcar, high-voltage cable or neon sign, which emitting interference wave or electromagnetic induction. Avoid any interfering object.

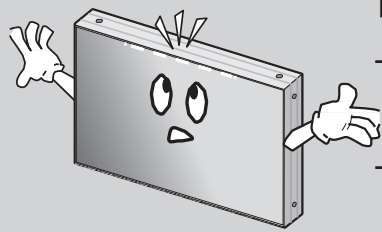

► Light leakage can be found at the edge areas around the screen.

- If the light leakage is not detected at 1m from the screen, the panel is considered as no defect. (LG LCD applies the same in specification standard)
- To minimize the light leakage, the monitor sets should be installed with high accuracy in horizontal and vertical position.

## 9. Applicable signals

※ Vertical Frequency : Standard ±0.5 Hz, Vertical Lines : Standards ±7 Lines \* H [dot] / V [line]

Resolution	Pixel Clock [MHz]	Horizontal [Pixels]				Vertical [Lines]				Polarity (H. / V.)	Standard Type	Input
		Total	Addr. Width	Sync. Width	Back Porch	Total	Addr. Width	Sync. Width	Back Porch			
640*480*60	25.175	800	640	96	40	525	480	2	25	- / -	DMT	DVI/ HDMI/ DP
800*600*60	40.002	1056	800	128	88	628	600	4	23	- / -	DMT	
1024*768*60	65	1344	1024	136	160	806	768	6	29	- / -	DMT	
1280*768*60	79.5	1664	1280	128	192	798	768	7	20	+ / +	CVT	
1360*768*60	85.5	1792	1360	112	256	795	768	6	18	+ / +	CVT	
1280*1024*60	108	1688	1280	112	248	1066	1024	3	38	- / -	DMT	
1600*1200*60	162	2160	1600	192	304	1250	1200	3	46	+ / +	DMT	
480P	27	858	720	62	60	525	480	6	30	- / -	CEA-861	HDMI/ DP
576P	27	864	720	64	68	625	576	5	39	- / -	CEA-861	
720P24	59.4	3300	1280	40	220	750	720	5	20	+ / +	CEA-861	
720P25	74.25	3960	1280	40	220	750	720	5	20	+ / +	CEA-861	
720P30	74.25	3300	1280	40	220	750	720	5	20	+ / +	CEA-861	
720P50	74.25	1980	1280	40	220	750	720	5	20	+ / +	CEA-861	
720P60	74.25	1650	1280	40	220	750	720	5	20	+ / +	CEA-861	
1080P24	74.25	2750	1920	44	148	1125	1080	5	36	+ / +	CEA-861	DVI/ HDMI/ DP
1080P25	74.25	2640	1920	44	148	1125	1080	5	36	+ / +	CEA-861	
1080P30	74.25	2200	1920	44	148	1125	1080	5	36	+ / +	CEA-861	
1080P50	148.5	2640	1920	44	148	1125	1080	5	36	+ / +	CEA-861	
1080P60	148.5	2200	1920	44	148	1125	1080	5	36	+ / +	CEA-861	
3840*2160*30	297	4400	3840	88	296	2250	2160	10	72	+ / +	-	HDMI/ DP
3840*2160*60	594	4400	3840	88	296	2250	2160	10	72	+ / +	-	

## 10. Specification

Product Name		UNB Multi-LCD Monitor			
Model Name		OLMU-K4650	OLMU-K4670	OLMU-K5550	OLMU-K5570
LCD Panel	Manufacture	SAMSUNG		LG	
	Back Light Unit Type	Direct LED			
	Module Dimension(H x V mm)	1021.98 x 576.6		1213.4 x 684.2	
	Active Display Area(H x V mm)	1018.08 x 572.7		1209.6 x 680.4	
	Number of Pixels(H x V)	1920 x 1080 (16:9)			
	Pixel Pitch(mm)	0.530 x 0.530		0.630 x 0.630	
	Display Colors	16.7M(8bit)		1.06Billion(10bits)	
	Luminance of White(Typ. cd/m <sup>2</sup> )	500	700	500	700
	Contrast Ratio(Typ.)	3,500 : 1		1,400 : 1	1,200 : 1
	Surface Treatment	Haze 44%, Anti-Glare, 3H		Haze 10%, Anti-Glare, 3H	
Life Time(Typ. Ta : 25±°C)	50,000Hrs		60,000Hrs		
Power Supply		AC 100V ~ 240V±10% (50/60Hz)			
Power Consumption(W)	Maximum	140	180	250	310
	Typ.	120	160	220	270
	Stand-By	≤ 0.5			
Seam Gap_Multi Configuration(Typ. mm)		3.7(Bezel to Bezel)		3.5(Bezel to Bezel)	
Dimension (W x H x D mm)		1022 x 576.6 x 100.8		1213.4 x 684.2 x 100.5	
Mounting (H x V mm)		580 x 340		600 x 400	
Weights (kg)		23 ± 0.5		32 ± 0.5	
Orientation		Portrait / Landscape			
Input Signal	Support Resolution	480p, 576p, 720p, 1080p, UHD			
	HDCP	Ready			
	Frequency	H : 31~140kHz, V : 29~76Hz			
In/Output Terminal	Input	DP x 1, HDMI x 1, DVI x 1, RS-232C x 1, LAN x 1, IR x 1, A/S x 1			
	Output	DP x 1, RS-232C x 1			

## 11. Regulatory Information

Manufacturer's Name: ORION CO.,LTD.

Manufacturer's Address : 217, 1gongdan-ro, Gumi-si, Gyeongsangbuk-do, Korea D  
eclares that the products Model Numbers: OLMU-K5550

Conforms with the provisions of:

Council Directive 2004/108/EC on Electromagnetic Compatibility; EN55022:2010 Radiated and C  
onducted Emissions from IT Equipment EN55024:2010 Immunity of IT Equipment

Including:	EN61000-4-2	Electrostatic Discharge
	EN61000-4-3	Radiated Immunity
	EN61000-4-4	Electrical Fast Transients
	EN61000-4-5	Line Surge
	EN61000-4-6	RF Conducted Susceptibility
	EN61000-4-8	Magnetic Field Immunity
	EN61000-4-11	Voltage Dips and Interrupts
	And:	EN61000-3-2
EN61000-3-3		Voltage fluctuations and Flicker

Council Directive 2006/95/EC on Low Voltage Equipment Safety:

EN60950:2006+A11+A1+A12 Safety of IT Equipment

**Note:** This equipment has been tested and found to comply with the limits for a Class A digital device, pursuant to part 15 of the FCC Rules. These limits are designed to provide reasonable protection against harmful interference when the equipment is operated in a commercial environment. This equipment generates, uses, and can radiate radio frequency energy and, if not installed and used in accordance with the instruction manual, may cause harmful interference to radio communications. Operation of this equipment in a residential area is likely to cause harmful interference in which case the user will be required to correct the interference at his own expense.

Any changes or modifications to the display not expressly approved by could void the user's authority to operate this equipment.

Other Certifications

CISPR 22

## 12. Dimension

### 12.1. OLMU-K4650 / OLMU-K4670

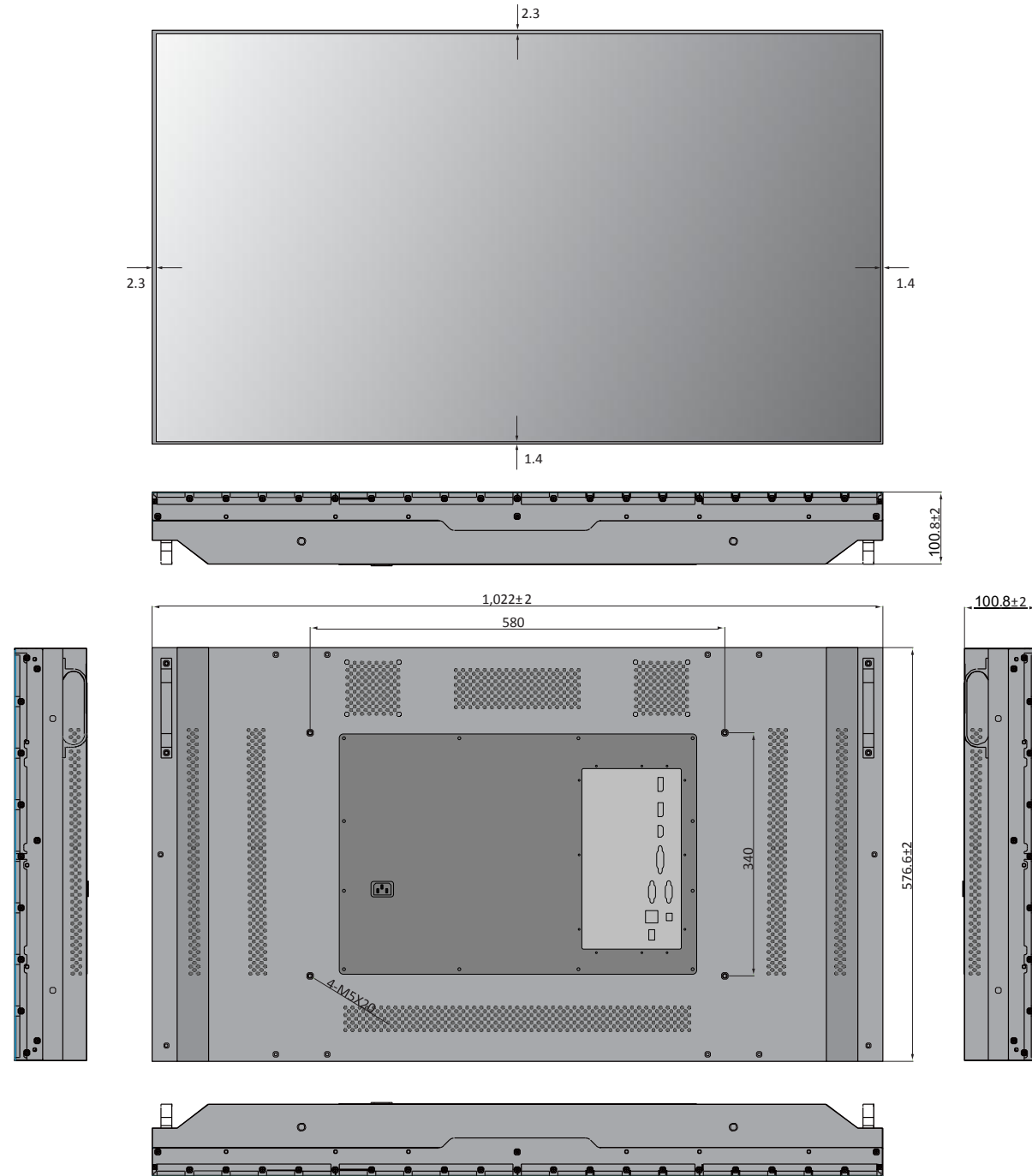

### 12.2. OLMU-K5550 / OLMU-K5570

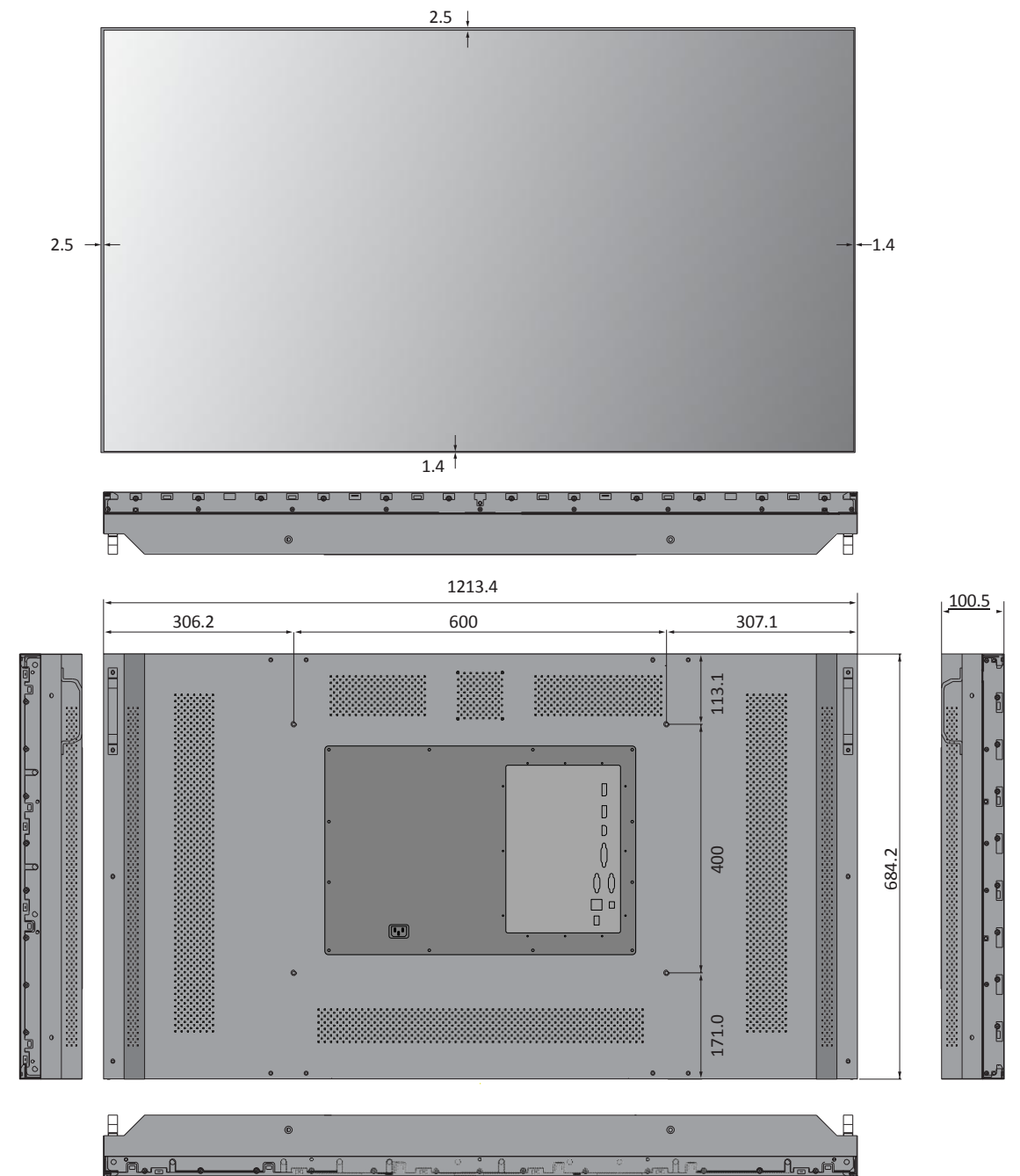



MEMO

MEMO