

A revolutionary MLCD
Hybrid Video System

A revolutionary MLCD
Hybrid Video System

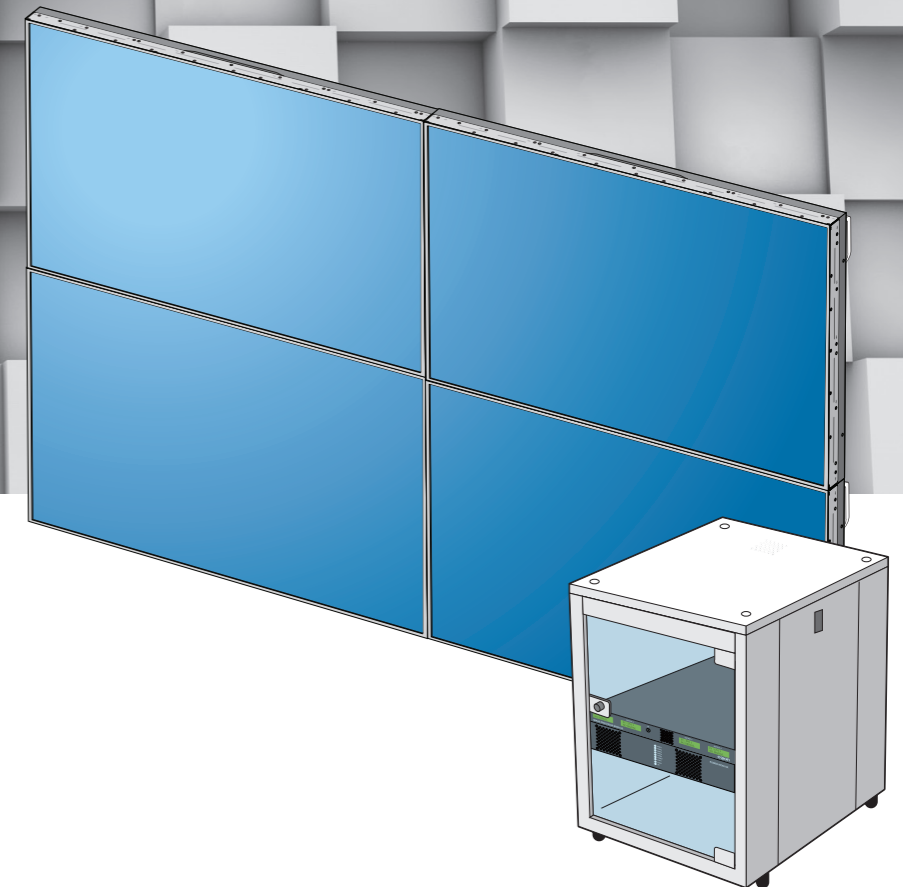

ORION CO.,LTD.
www.oriondisplay.net

Address: 257-6, Gongdan-dong, Gumi-si, Gyeongsangbuk-do, Korea
Tel : +82-2-6678-8533, Fax: +82-2-6678-8599

User's Manual
OLW-5550

Thank you for purchasing our MLCD.
Please read through this user's manual for safety before installing this product.
This product is manufactured for Multi LCD model only.

Features of MLCD

- ▶ Enjoy a wide flat screen with high brightness and high quality.
- ▶ Easy to install and move due to its thin design
- ▶ Enjoy your favorite programs with various split-screen features simultaneously presenting several programs.

Thank you for purchasing our MLCD monitor.









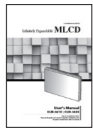

This manual describes how to use the product and notes in use.
 Please read the manual carefully before using it.
 After reading this manual, please retain for future reference.
 If you have any questions or a problem occurs, please contact either the company you purchased this product from or an authorized service center.

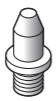
- ※ **Displaying static picture for an extended period of time may cause an burn-in effect.**
- ※ **Burn-in effect and the faults in brightness and picture elements caused by fixed images are not subject to the warranty coverage.**

 **Warning** If you fail to comply with the regulations for safety and proper use, fire or injury may be caused.

 **Warning** To prevent electric shock, Do not remove cover.
 No user serviceable part inside
 Refer servicing to qualified service personal.

Supplied Accessories

User's Manual 	Multi-Screen Control System(MSCS) 	Guide Pin(4pcs) 	Power Cable 	CAT-6 Cable(1EA) 	DC Power Cable(1EA) 
 Power Module	 Image Processor Module	VIDEO Cable (1ea per panel) The length may vary according to customers' request. (2, 3, 5, 7, 10, 15, 20, 30M) 	COMM Cable (1ea per panel) The length may vary according to customers' request. (2, 3, 5, 7, 10, 15, 20, 30M) 	DC Power Cable (1ea per panel) The length may vary according to customers' request. (2, 5, 8, 10, 15, 20M) 	

Optional Accessories

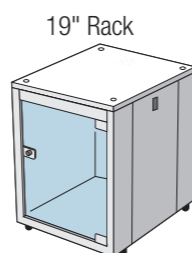
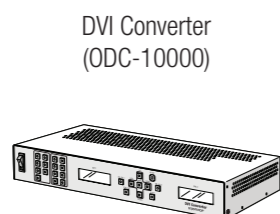
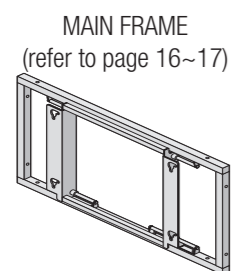

Notice to users



Class A digital device

It is a device designed for business purpose with a safety certificate for electromagnetic interference, which user should be mindful of.

" Important Safety Instructions"

- 1) Read these instructions.
- 2) Keep these instructions.
- 3) Heed all warnings.
- 4) Follow all instructions.
- 5) Do not use this apparatus near water.
- 6) Clean only with dry cloth.
- 7) Do not block any ventilation openings. Install in accordance with the manufacturer's instructions.
- 8) Do not install near any heat sources such as radiators, heat registers, stoves, or other apparatus (including amplifiers) that produce heat.
- 9) Do not defeat the safety purpose of the polarized or grounding-type plug. A polarized plug has two blades with one wider than the other. A grounding type plug has two blades and a third grounding prong. The wide blade or the third prong are provided for your safety. If the provided plug does not fit into your outlet, consult an electrician for replacement of the obsolete outlet.
- 10) Protect the power cord from being walked on or pinched particularly at plugs, convenience receptacles, and the point where they exit from the apparatus.
- 11) Only use attachments/accessories specified by the manufacturer.
- 12) Use only with the cart, stand, tripod, bracket, or table specified by the manufacturer, or sold with the apparatus. When a cart is used, use caution when moving the cart/apparatus combination to avoid injury from tip-over.

- 13) Unplug this apparatus during lightning storms or when unused for long periods of time.
- 14) Refer all servicing to qualified service personnel. Servicing is required when the apparatus has been damaged in any way, such as power-supply cord or plug is damaged, liquid has been spilled or objects have fallen into the apparatus, the apparatus has been exposed to rain or moisture, does not operate normally, or has been dropped.
 The symbol in figure 21 shall be shown adjacent to the text of item 12 above.

	CAUTION RISK OF ELECTRIC SHOCK DO NOT OPEN	
<p>CAUTION : TO REDUCE THE RISK OF ELECTRIC SHOCK, DO NOT REMOVE COVER (OR BACK). NO USER-SERVICEABLE PARTS INSIDE. REFER SERVICING TO QUALIFIED SERVICE PERSONNEL.</p>		



This symbol is intended to alert the user to the presence of uninsulated "dangerous voltage" within the product's enclosure that may be of sufficient magnitude to constitute a risk of electric shock to persons.



This symbol is intended to alert the user to the presence of important operating and maintenance(servicing) instructions in the literature accompanying the appliance.

NOTICE

1. To disconnect the apparatus from the mains, the plug must be pulled out from the mains socket, therefore the mains plug shall be readily operable
2. WARNING - To Reduce The Risk Of Fire Or Electric Shock, Do Not Expose This Appliance To Rain Or Moisture.
3. Apparatus shall not be exposed to dripping or splashing and no objects filled with liquids, such as vases, shall be placed on the apparatus.
4. Use only a properly grounded plug and receptacle
5. "Warning" CAUTION – These servicing instructions are for use by qualified service personnel only. To reduce the risk of electric shock, do not perform any servicing other than that contained in the operating instructions unless you are qualified to do so.
6. "Warning" CAUTION – These servicing instructions are for use by qualified service personnel only. To reduce the risk of electric shock, do not perform any servicing other than that contained in the operating instructions unless you are qualified to do so.

Contents

1. Safety Precautions	10
2. Guidance for Users	12
2.1. LCD Panel	12
2.2. Receiver Module	13
2.3. Power Module	14
2.4. Image Processor Module	15
3. How to Install	16
4. How to Connect Cables	18
4.1. Single Image Processor Connection (for One 2X2 MLCD formation)	18
4.2. Multi Image Processor Connection (for two or more 2X2 MLCD formation)	20
5. Setting and operation of MSCS software	22
5.1. MSCS Installation	22
5.2. Start MSCS	23
5.3. Control signal connections	24
5.3.1. Setting of COM Port	24
5.3.2. Setting of LAN Port	25
5.4. "New design/Last design" setting	30
5.5. Selecting the command transmission method	31
5.6. Image Processor Configuration	32
5.7. Multi Screen Configuration	33
5.9. Power On/Off	37
5.8. Input Channel Change	38
5.8.1. Play button	38
5.8.2. Mouse (left button use)	39
5.8.3. Mouse Drag & Drop	40
5.10. Loop Out (Daisy-Chain Out) Channel Configuration	41
5.11. Slide Show	42
5.12. Picture Control	47
5.13. Timer Control	48
5.14. Equalizer Control	49
5.15. Option Control	51
5.16. ORION Homepage log on and Version Information	52
6. MSCS Protocol	53
*Attachment : ASCII to HEX Conversion Table	75
7. Before calling for service	76
8. DVI Resolution	77
9. Specification	78

※ Cautions for consisting System

Caution for the other control program besides MLCD Control Program (MSCS)

- If you want to use automatic power on/off function that make MLCD turned on/off by connecting main power, allow at least 20 seconds of Stand-by time before MLCD is turned on, when you make control program.
- If RS-232C communication signal or other image signal is applied to 9 or more sets simultaneously, communicational error may occur. (Power on & Broadcast)

Environmental condition for installation

- Since MLCD panel is very sensitive for physical impact, installation requires considerable caution.
- Minimum clearance(20cm) must be secured for smooth ventilation. (See page 5, 16~17) Installation must avoid air tight or near air tight places. Improper ventilation causes malfunction and shortens product lifetime by rapid internal temperature rise. If MLCD has to installed at the improper ventilation, additional ventilation openings or fans must be provided to keep the internal temperature between 0 ~ 35°C.
- For ground of MLCD and application devices, it should be connected as frame ground.
- Considering MLCD Max power consumption, check the main electric specification.

Consideration for easier service

- When you design the exterior design for MLCD system, consider easier disassembly for possible service occasion in the future.
- The sliding Universal Unit of ORION is recommended for easier service.
- If service people can step into the backside of MLCD system, it can greatly reduce time and effort for service.
- In case of higher locations, consider the installation location and exterior design for easier service.

※ Clearance for Ventilation



- When you install MLCD, make sure there is at least 20cm clearance for effective ventilation and do not seal off MLCD sets.
- If MLCD sets are installed at the locations of bad ventilation, the inner temperature can be raised rapidly and it can cause frequent malfunctions and rapid reduction of the product life.

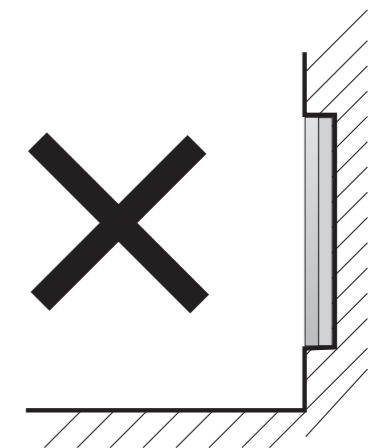
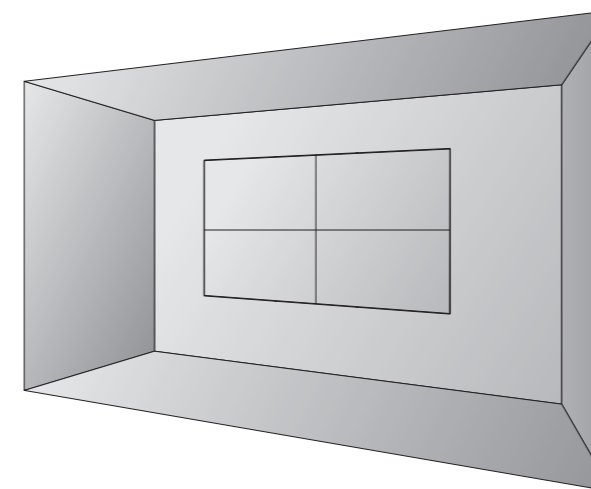
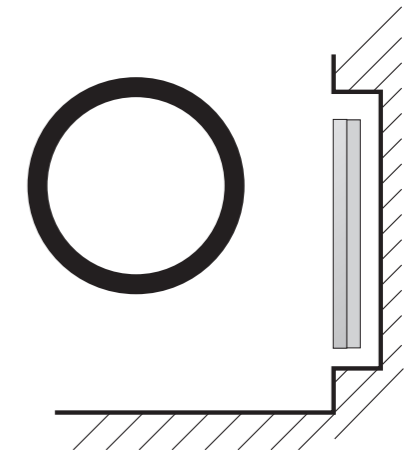
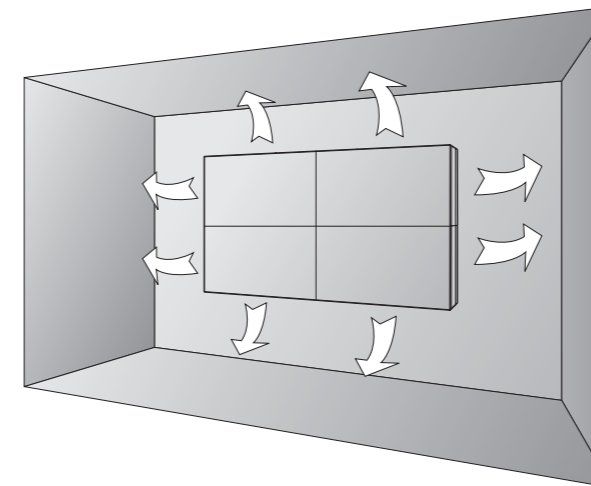

- ※ Ventilation space in front of MLCD must be furnished for heat dispersion. If the front space of MLCD has to be sealed, there must be consideration for the heat dispersion in the rear side of MLCD.

WARNING



※ Please keep following instruction for panel protection without exception.

- This product can be damaged even with minor impact for its nature. Please keep following instruction to carry or store the products.

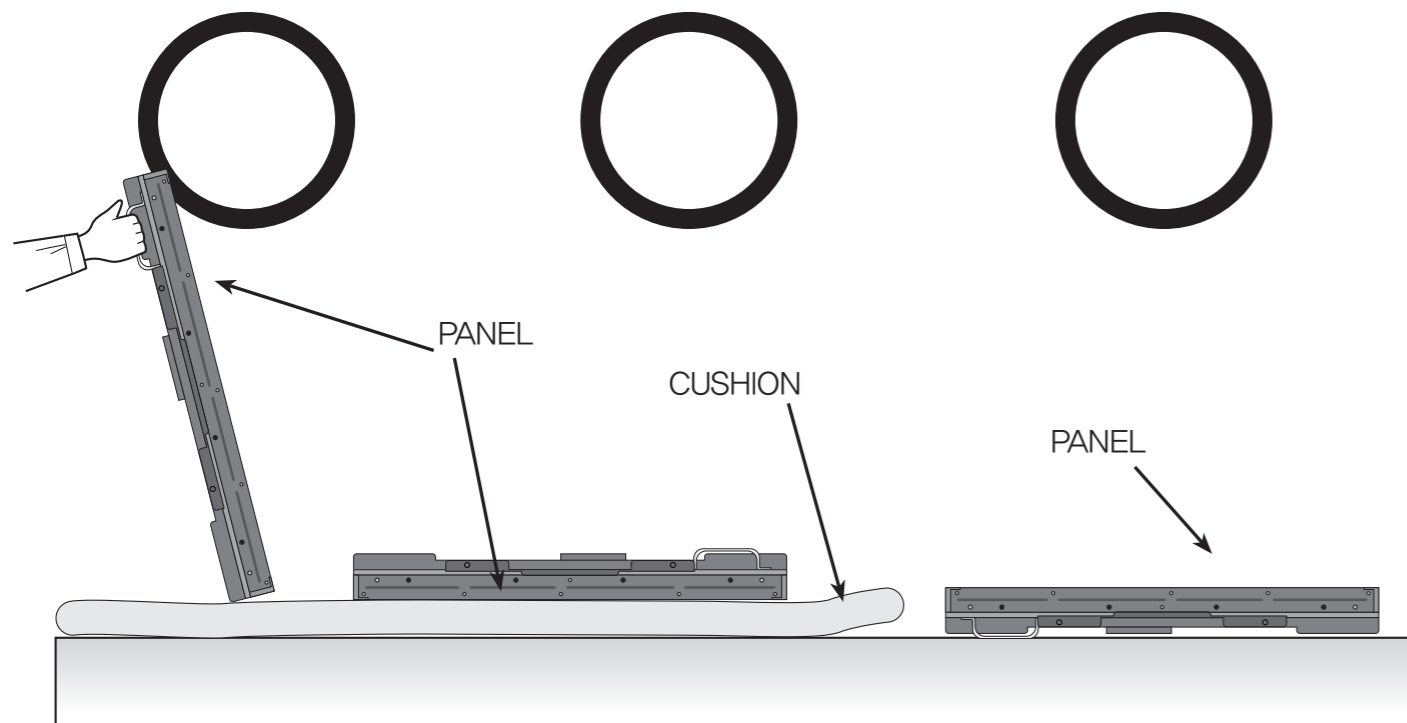

- If you need to stand LCD, you must use handles on the back and lean over the LCD to avoid panel touches ground or floor.
- If you need to lay down LCD as face down position, please use shock-absorbing pads under the LCD.
- If you need to lay down LCD as face up position, please be cautious for falling objects on the surface of the LCD.



※ Handle with Caution.

- Shock/Impact on the set's sides will result in internal circuit damages.
- The edge/bottom of the panel are fragile. Use shock-absorbing pads or rugs for laying down the product.

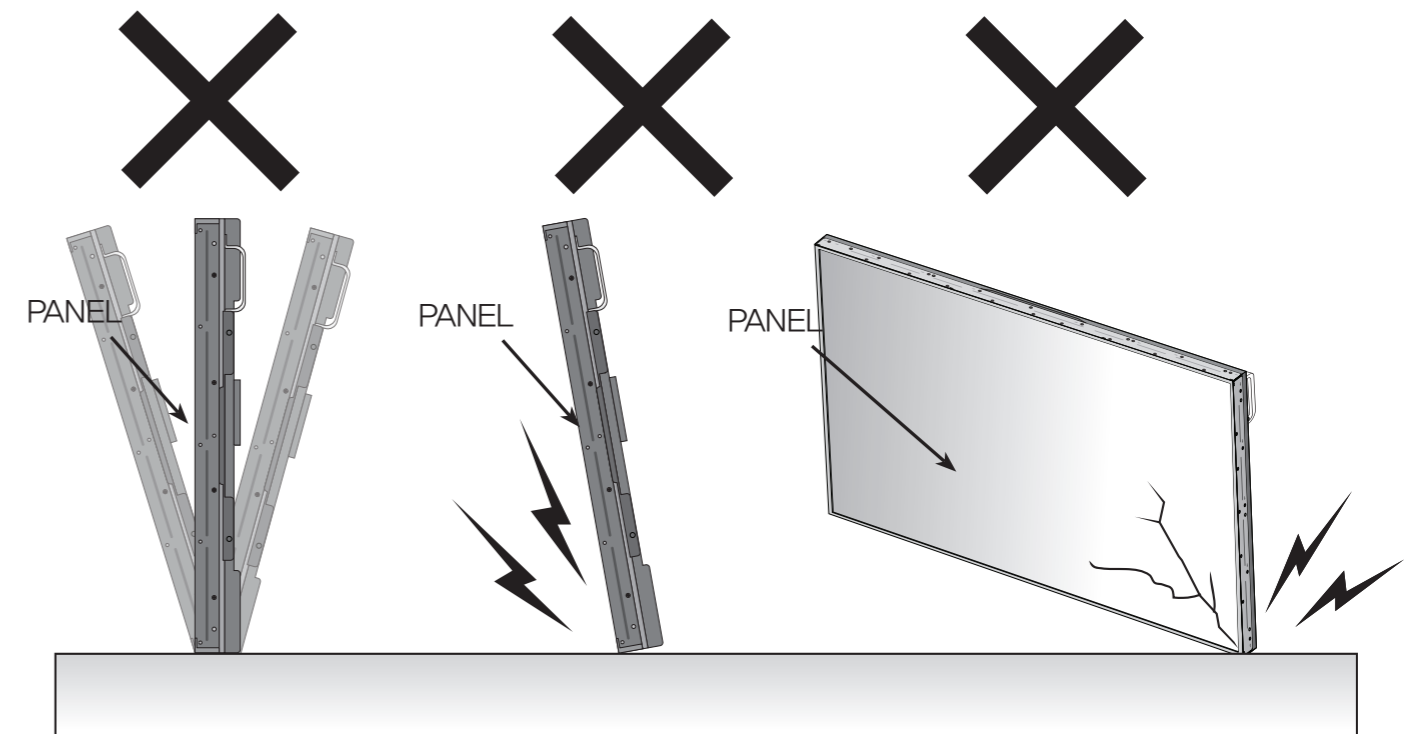

- Please do not stand LCD alone. It may fall or slip off and Panel can be broken or damaged.
- Please do not lean over the LCD. It may damage the bottom part of the LCD.
- Please do not lean over the LCD toward the edge part. It may damage the edge part of the LCD.

WARNING

※ How to carry MLCD

It always needs two persons to carry or install MLCD.
 When you carry MLCD with up straight manner, please hold handles on the back and bottom part of the panel together.
 Please be careful not to touch the bottom part of the panel when you put down the panel.

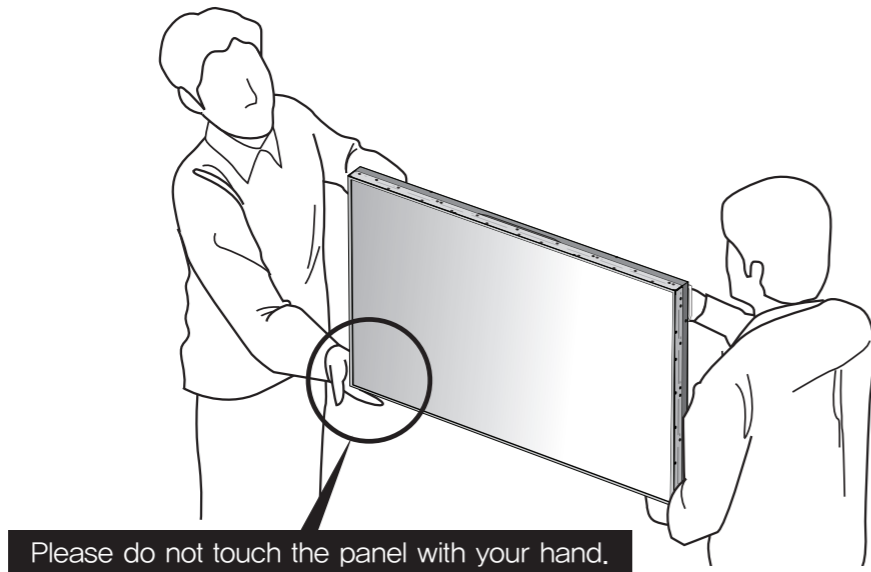

When you carry MLCD with flatbed manner, please hold handles on the back and lower part of the back.
 Please be careful not to touch the bottom part of the panel when you put down the panel.

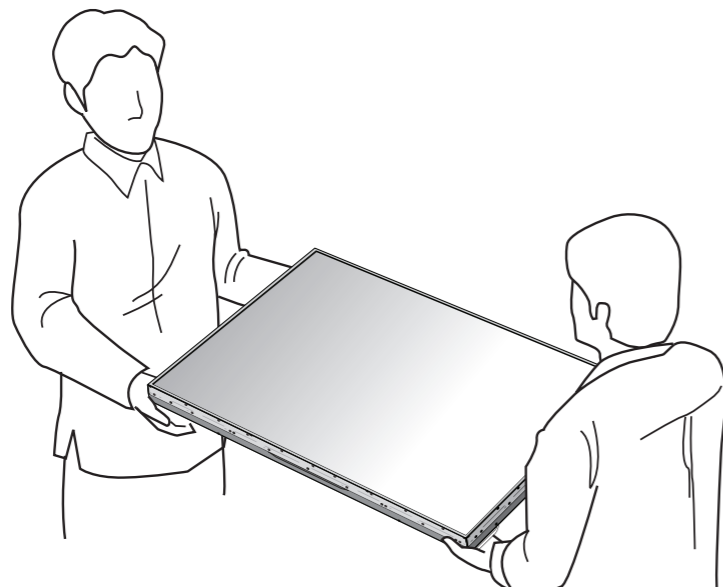

※ Application information

If static images are displayed on the screen for a long time, it causes burn-in image.
 Please keep the following instruction to optimize the lifetime and functions of the product.

1. Operating condition

- Temperature: 20 ± 15°C
- Humidity: 55 ± 20 %
- Display pattern: moving picture or regular switchover display
- Environmental condition : Well ventilated place is recommended.
- Power off and screen saver : Periodical power-off or screen saver is needed after long-term static display.

※Note : Moving picture or black pattern is strongly recommended for screen saver.

2. Operating methods to minimize burn-in image due to long-term static information display

- Suitable operating time : under 20 hours a day.
- Periodical display contents change from static image to moving picture.
- Periodical background color and character (image) color change

DEPARTURE			DEPARTURE		
Flight No.	Time	Gate	Flight No.	Time	Gate
UA 012	11:20	A02	UA 012	11:20	A02
KE 732	12:10	K17	KE 732	12:10	K17
AN 291	12:45	F11	AN 291	12:45	F11

- Change the images of little luminance difference between the background and characters, periodically.

DEPARTURE			DEPARTURE			DEPARTURE			DEPARTURE		
Flight No.	Time	Gate	Flight No.	Time	Gate	Flight No.	Time	Gate	Flight No.	Time	Gate
UA 012	11:20	A02	UA 012	11:20	A02	UA 012	11:20	A02	UA 012	11:20	A02

- It is not recommended to display the images of huge luminance difference between the background and characters or the images of grey tone.

ARRIVAL				ARRIVAL			
Flight No.	Time	Gate	Delay	Flight No.	Time	Embark	Delay
AA 213	9:20	K11	On time	AA 213	9:20	New York	On time
OZ 621	11:25	G21	10 min.	OZ 621	11:25	Seoul	10 min.
JA 032	12:05	A19	On time	JA 032	12:05	Beijing	On time

- Scroll the characters periodically.

DEPARTURE			DEPARTURE			DEPARTURE		
Flight No.	Time	Gate	Flight No.	Time	Gate	Flight No.	Time	Gate
UA 012	11:20	A02	UA 012	11:20	A02	UA 012	11:20	A02
KE 732	12:10	K17	KE 732	12:10	K17	KE 732	12:10	K17
AN 291	12:45	F11	AN 291	12:45	F11	AN 291	12:45	F11

(Whole Screen Scroll)

WARNING

WARNING

1. Safety Precautions

- If it operates abnormally, stop using it immediately.

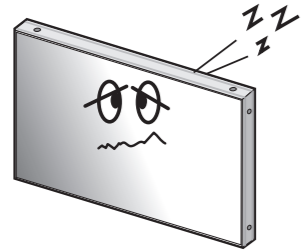

- Do not place any liquid-containing container on it. If the inside is wet, it may cause electric shock or fire.

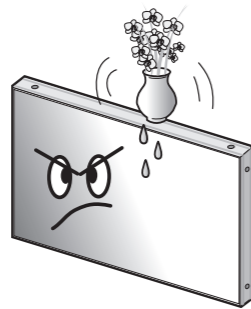

- Do not put any foreign material into the product. It may cause a failure or shorten the life span.

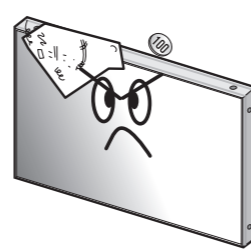

- Please refer to a specialized construction company for installing stand or wall mount unit. Otherwise, damage or injury may be caused.



- Do not touch the device when lightning strikes.

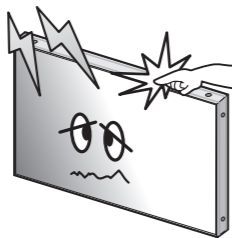

- Do not install in an unstable location. It may cause injury.

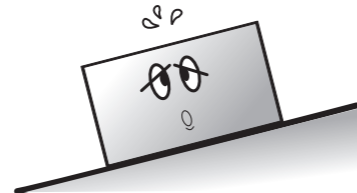

- Avoid any action to damage the power cord or power plug. It may cause fire or electric shock.

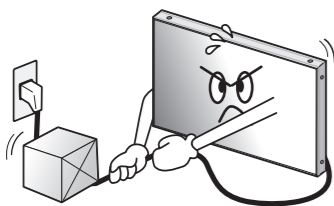

- Do not pull out the power plug with a wet hand. It may cause electric shock.



- Do not exceed ratings of AC outlet or extension cords. It may cause failure.

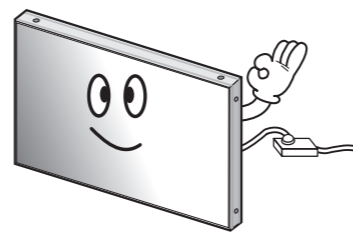

- Do not alter (or disassemble) the product. It may cause electric shock since high voltage is flowing inside.

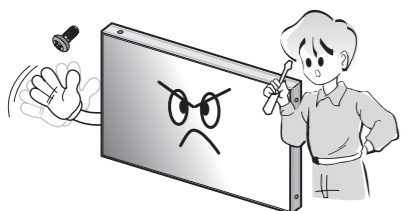

- Do not install the product where it may be exposed to direct sunlight or near any heating device. It may shorten the product's life span or cause failure.

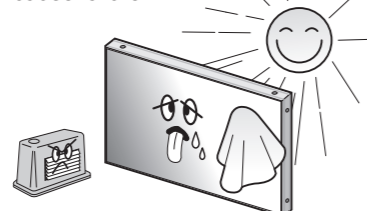

- Make sure the product is not covered with any object. If the ventilation hole is blocked, the inside temperature may rise to cause overheating resulting in fire.



- Do not pull out or hang down the connection cable. It may damage the cord to cause fire or electric shock.

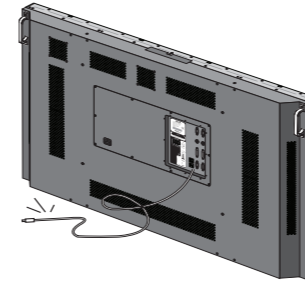

- Do not lean against the product or keep it leaned. It may cause injury or failure.

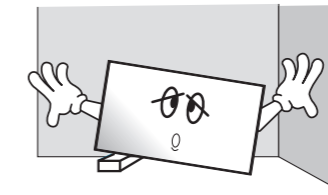

- Do not put it at any place with much humidity, dust, oil, smoke or steam. It may cause failure.

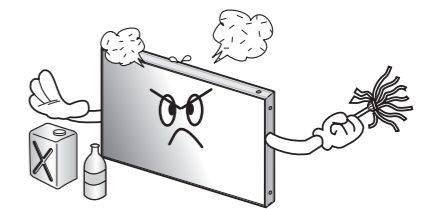

- Pull out the power plug by holding the plug. Otherwise, it may damage the power cord to cause fire or electric shock.

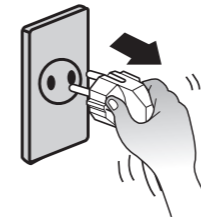

- If you do not want to use the product for a long time, keep the power plug unplugged to save electricity.
- The socket-outlet should be installed near the equipment and be easily accessible.

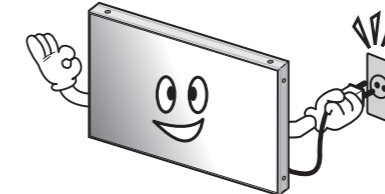

- Do not put any heavy object on it. It may cause failure.

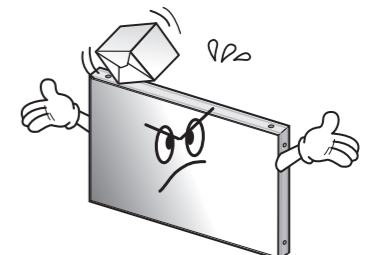

- Install the product on safe and flat surface.

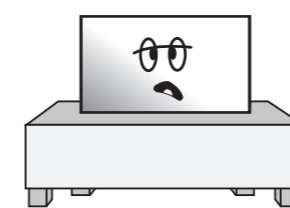

- Do not ride or step on the product. It may cause breakage when fallen down.

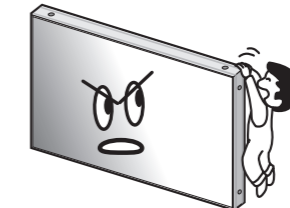

- When moving it, disconnect the connecting cable. Otherwise, it may damage the cable to cause fire or electric shock.

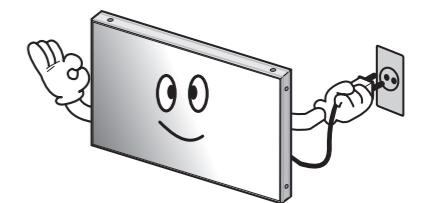

- Do not put candles on the product. If the liquid flows inside the product. It may cause electric shock or fire.

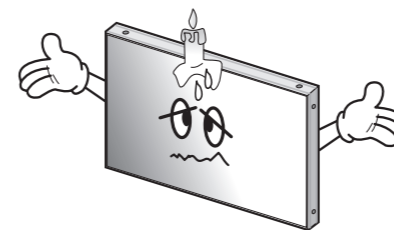

- Do not touch product's front surface with hand. Otherwise, the image quality can be lowered.

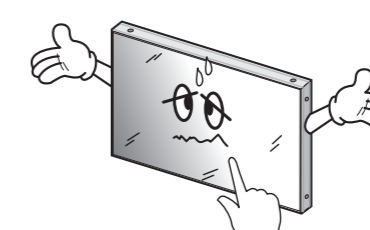

- Do not poke the front screen with sharp material. It may damage the screen and may cause malfunction of the product.

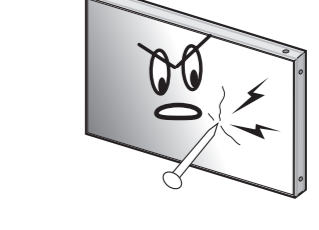

2. Guidance for Users

2.1. LCD Panel



▪ Front

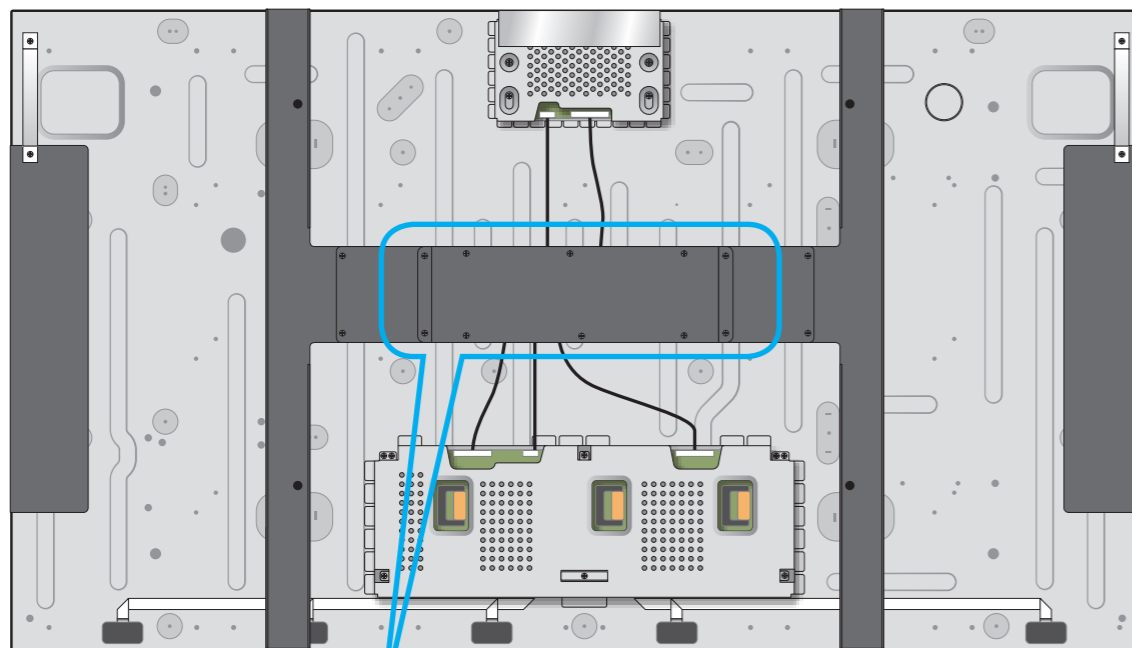

▪ Rear

Receiver Module

2.2. Receiver Module

▪ Upper Deck

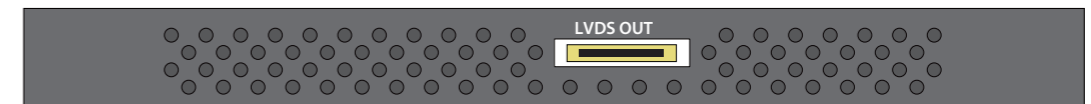

①. **LVDS OUT** : Output port for transferring LVDS signal to LCD Panel

▪ Lower Deck



①. **BLU1 ~ BLU2** : Power supply and control signal input ports for the back light unit in LCD panel

②. **VIDEO** : Image signal input port

③. **COMM** : Control signal input port

④. **ID** : ID configuration switch for Receiver Module

2.3. Power Module

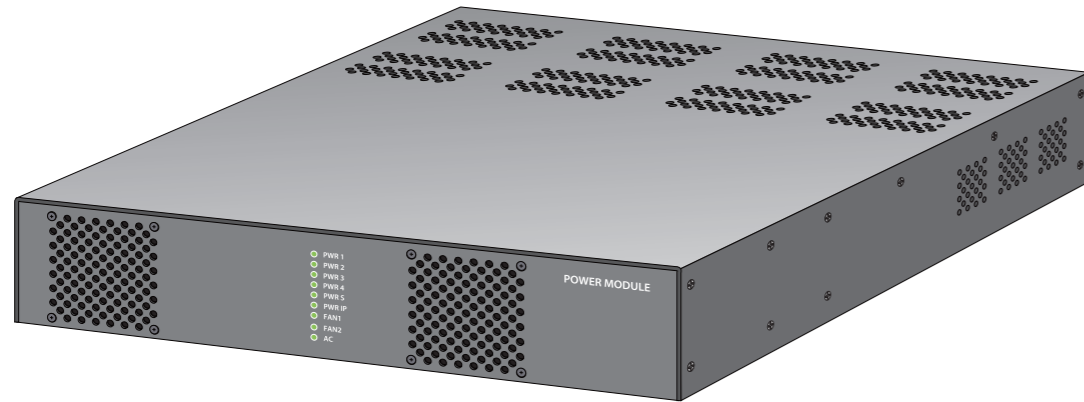

■ Front



- ①. **PWR 1 ~ PWR 4** : Indicator LEDs of the power output port for the Receiver Module 1 ~ 4
- ②. **PWR S** : Indicator LED for the back-up power output port
- ③. **PWR IP** : Indicator LED of the power output port for Image Processor Module
- ④. **FAN1 ~ FAN2** : Indicator LED for the fans in the front
- ⑤. **AC** : Indicator LED for AC power input

■ Rear

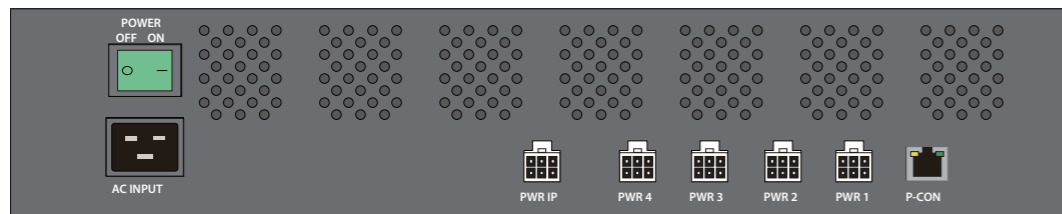

- ①. **POWER** : AC Power On/Off switch
- ②. **AC INPUT** : AC Power input port
- ③. **PWR IP** : Power output port for Image Processor Module
- ④. **PWR 4** : Power output port for Receiver Module 4
- ⑤. **PWR 3** : Power output port for Receiver Module 3
- ⑥. **PWR 2** : Power output port for Receiver Module 2
- ⑦. **PWR 1** : Power output port for Receiver Module 1
- ⑧. **P-CON** : Control signal input port for Power Module

2.4. Image Processor Module



■ Front



- ①. **Output 1 ~ 4** : Indicates the operating status of each Image Processor.
 - Firmware information
 - Input port information for image signal
 - Input image resolution
 - On/Off information for image output port (If the window is off, the port is off.)
- ②. **ID** : ID input switch for image Processor (For multi Image Processors)

■ Rear



- ①. **PWR** : Power input port for Image Processor Module
- ②. **LAN** : Ethernet signal input port
- ③. **P-CON** : Power Module control port
- ④. **232IN** : RS-232C signal input port
- ⑤. **232OUT** : RS-232C signal output port (for Daisy Chain)
- ⑥. **DVI IN1 ~ 4** : DVI signal input ports
- ⑦. **LOOP IN** : DVI signal input port for multi Image Processors
- ⑧. **LOOP OUT** : DVI signal output port for multi Image Processors
- ⑨. **COMM1 ~ COMM4** : Receiver Module control signal output port
- ⑩. **VIDEO1 ~ VIDEO4** : Receiver Module image signal output port

3. How to Install

MAIN FRAME Stand Unit (Option)

- Please do not install our product at following locations to protect the product and prevent possible malfunction.
 - Places of vibration or shock: LCD set may fall and damaged
 - Next or near to Sprinkler sensors: The sensors may detect heat from a set and sprinkler can be activated.
 - Around high voltage power lines: Noise from the power line may affect screen images
 - Around heating apparatus: LCD set may be overheated and damaged.

- The set can be installed as shown below.
(For further information, refer to the optional 'MAIN FRAME Installation and Setup Guide'.)

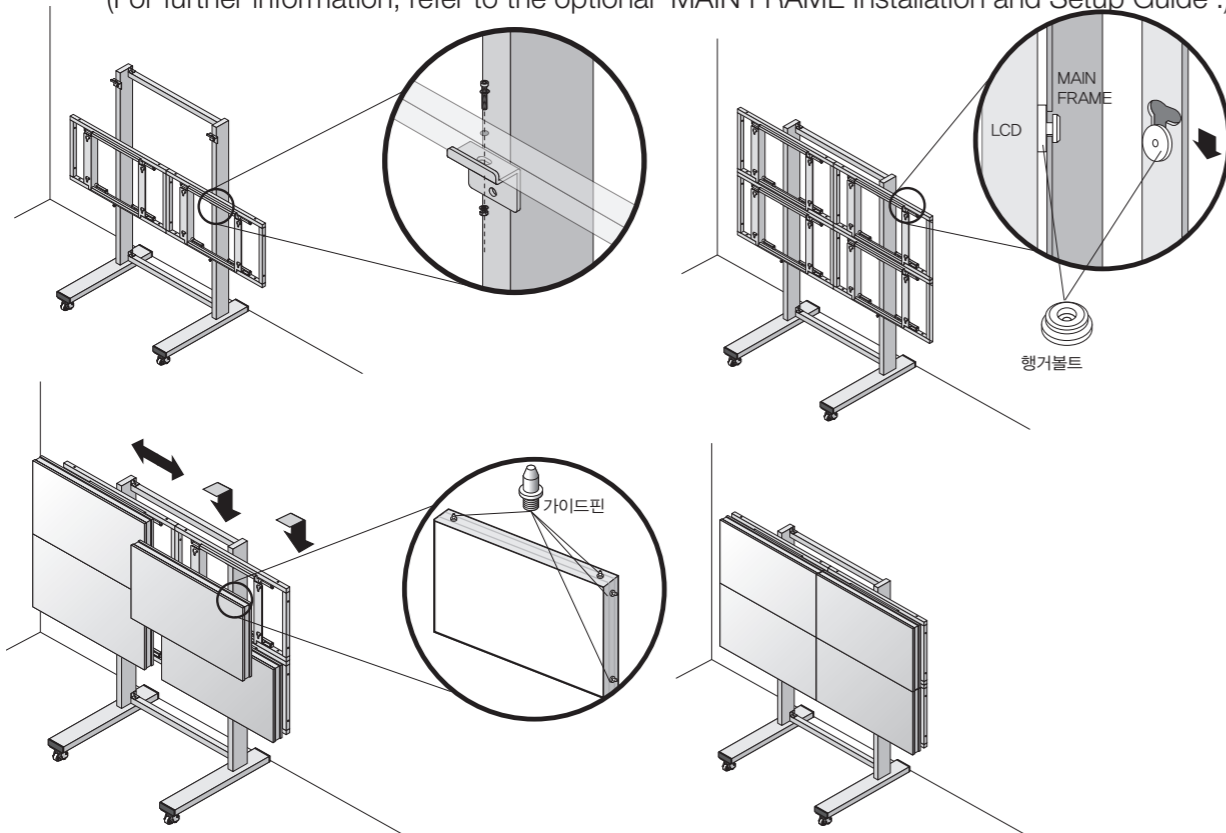

Install on a MAIN FRAME Stand

Please secure minimum clearance as shown in the picture for adequate ventilation and technical service.

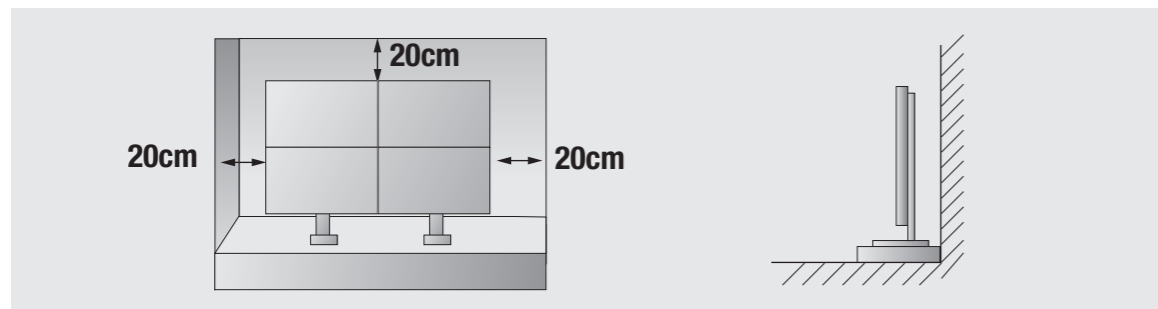

MAIN FRAME Wall Mounting Unit (Option)

- Please check the stability of wall.
If the wall is not strong enough, reinforce the wall before installation.
- Please connect all the cables to proper ports in a set before installation.

- The set can be installed on the wall as shown below.
(For further information, refer to the optional 'MAIN FRAME Installation and Setup Guide'.)

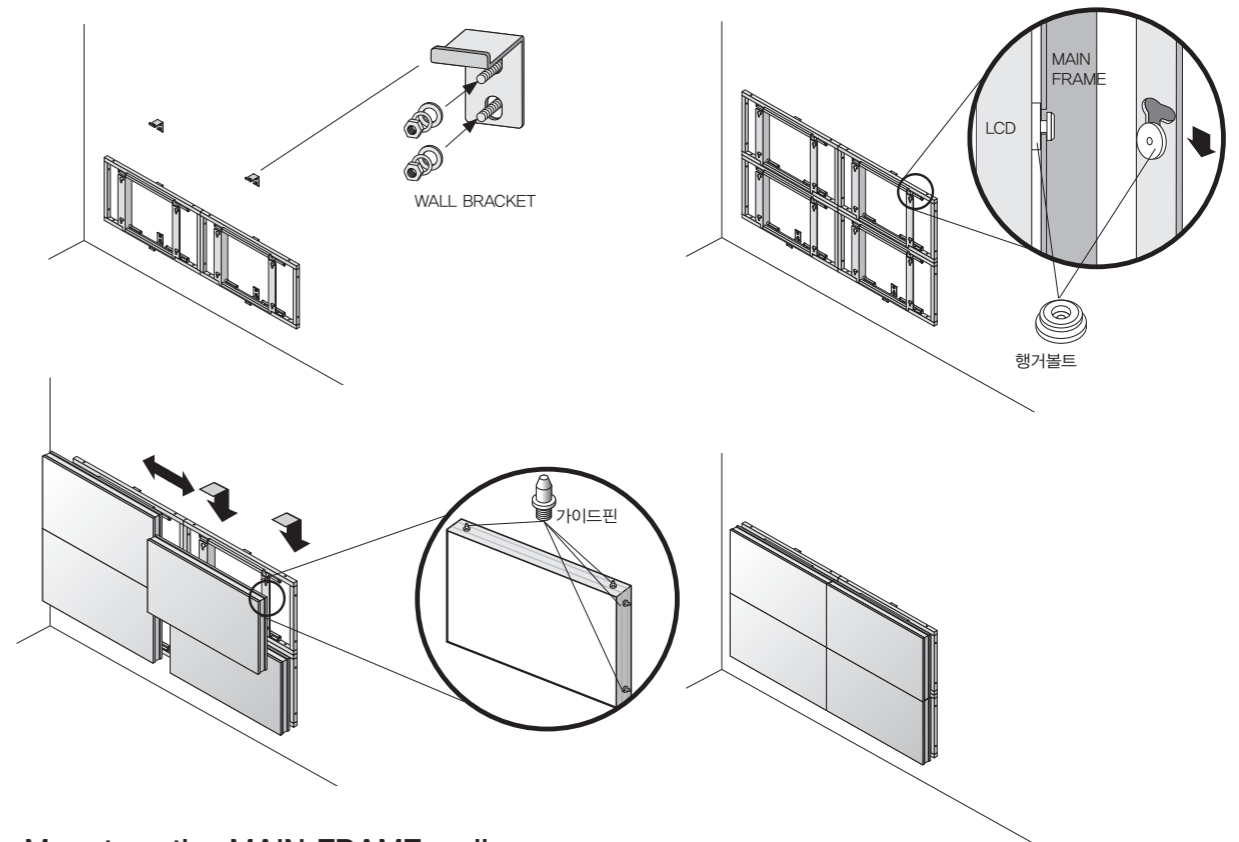

Mount on the MAIN FRAME wall

Please secure minimum clearance as shown in the picture for adequate ventilation and technical service.

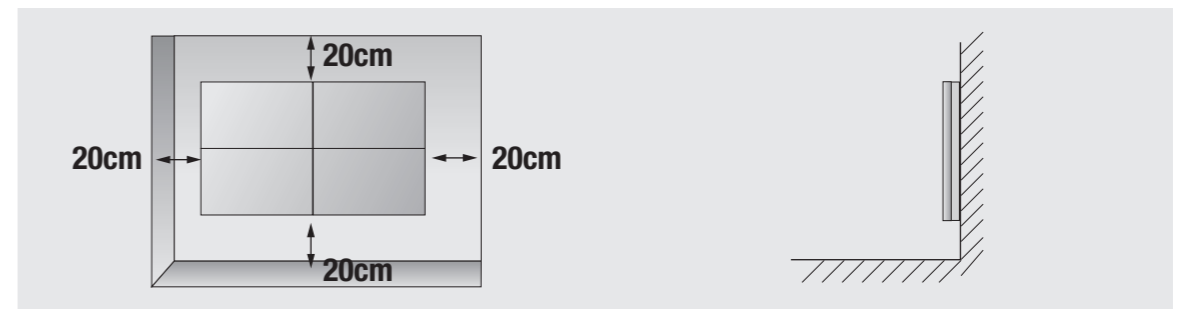

4. How to Connect Cables

- Do not connect/disconnect cables while MLCD or other external equipments are turned on.
- First turn off the power all the attached equipment and make connections.

4.1. Single Image Processor Connection (for One 2X2 MLCD formation)

- Connect the RS-232C IN port of the Image Processor to the Com port of the PC with RS-232C cable.
- Use MSCS (Multi-Screen Control System) program to turn on or off the display and control the screen.
- To control the display, the ID on the Image Processor and the ID in the MSCS must be identical.
- In case there is no Com port, it is necessary to use the converting gender from USB to RS-232C. There can be some malfunctions based on the gender makers.
- The IDs for each Receiver Module must not be overlapped. It should be set from 1 to 4.
- The ID for Image Processor must be set as 1.
- The IDs for Image Processor and Receiver should be set after turning off the power.

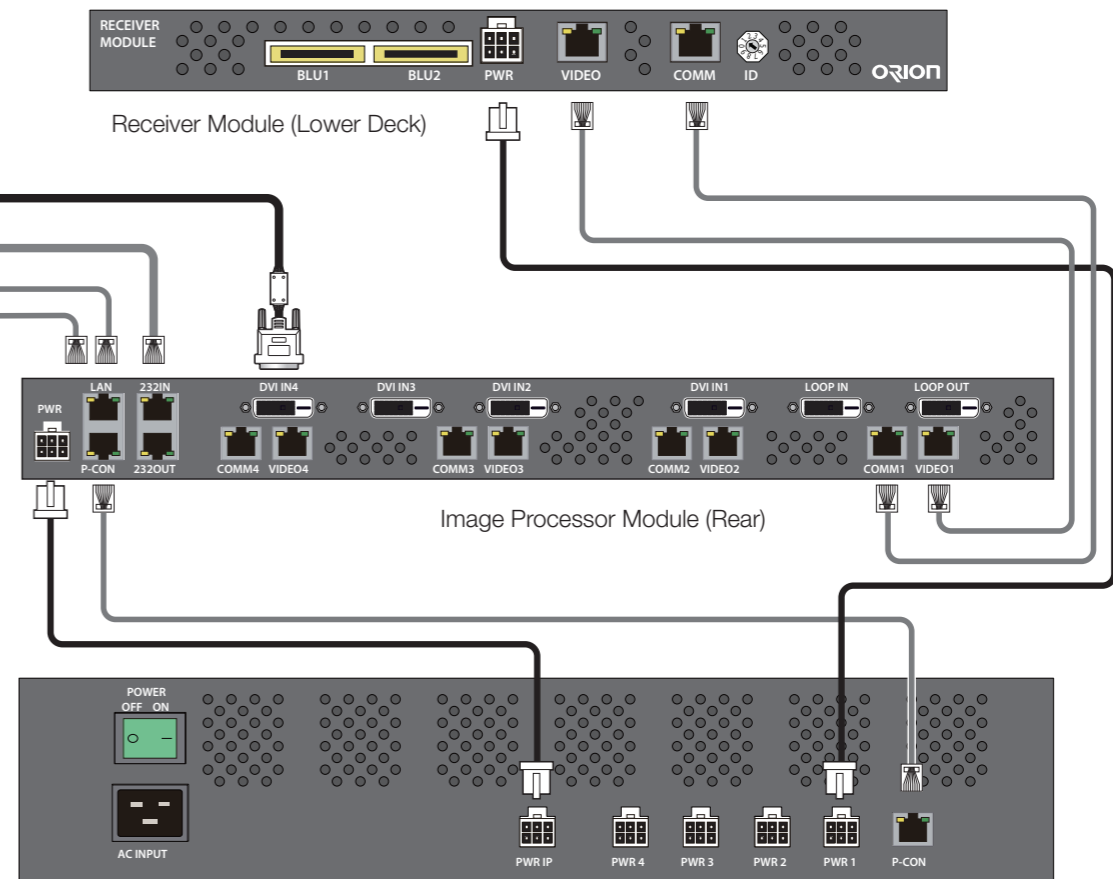
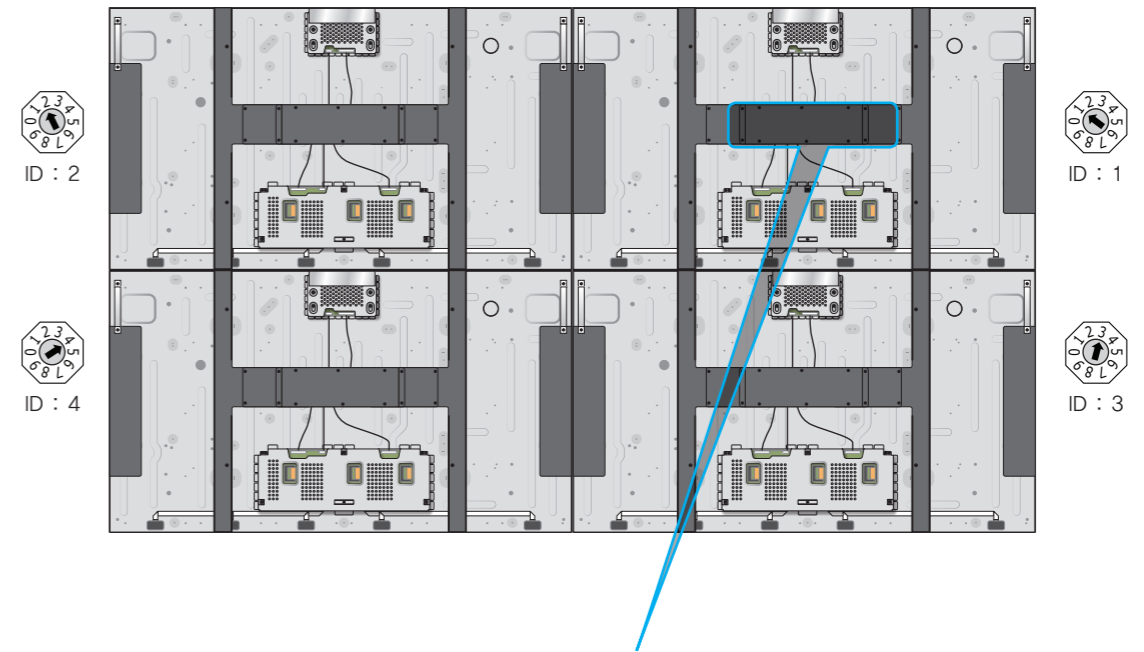
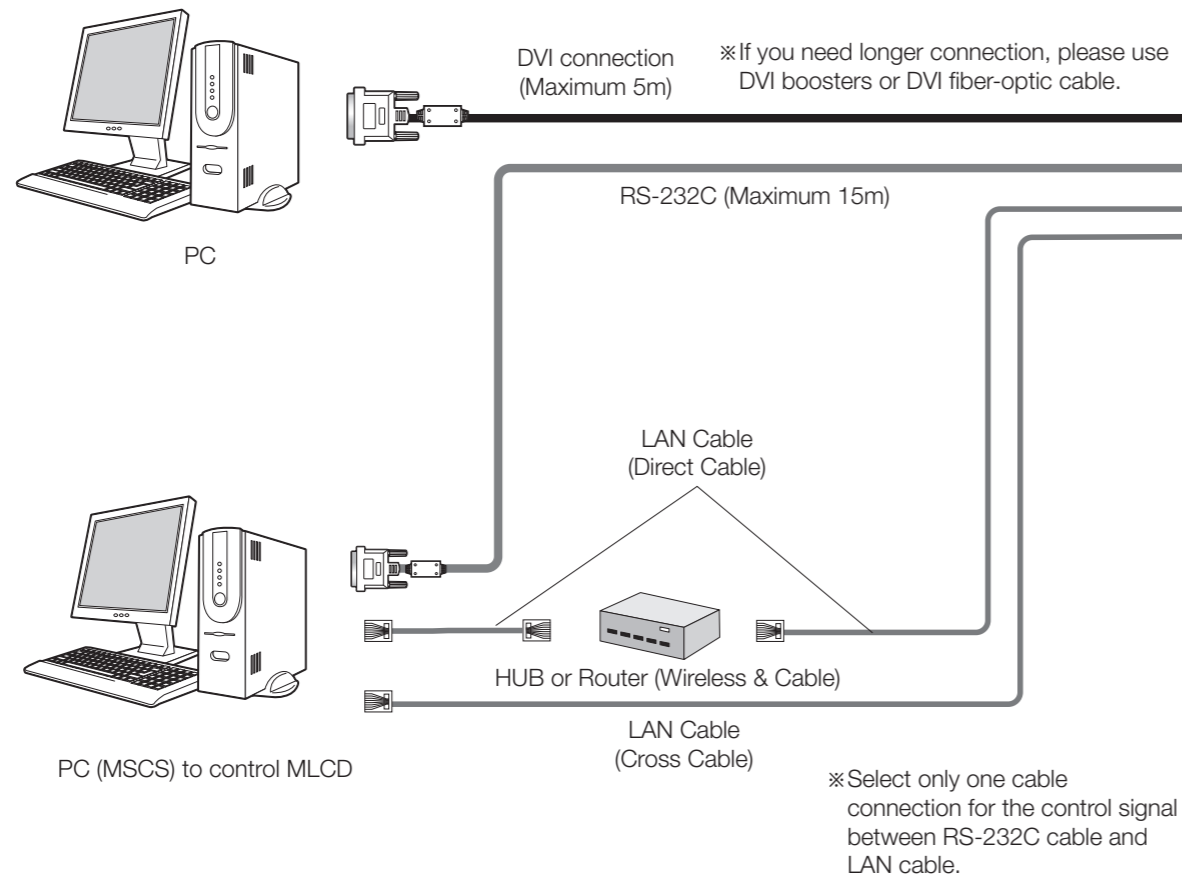

※ Make sure there is at least 4.4cm (1U) clearance between Image Processor Module and Power Module.

4.2. Multi Image Processor Connection (for two or more 2X2 MLCD formation)

- This instruction is for multi Image processor connection (More than 2 Image processors)
- Configure the ID in the front side of the Image Processor to connect more than 2 Image processors.
- Configure the IDs for Image Processor and Receiver after turning off the power.
- RS-232 signal must be used for the control signal connection between Image Processors.
- Only the first Image Processor, which is connected to the LAN port, can be controlled via LAN.

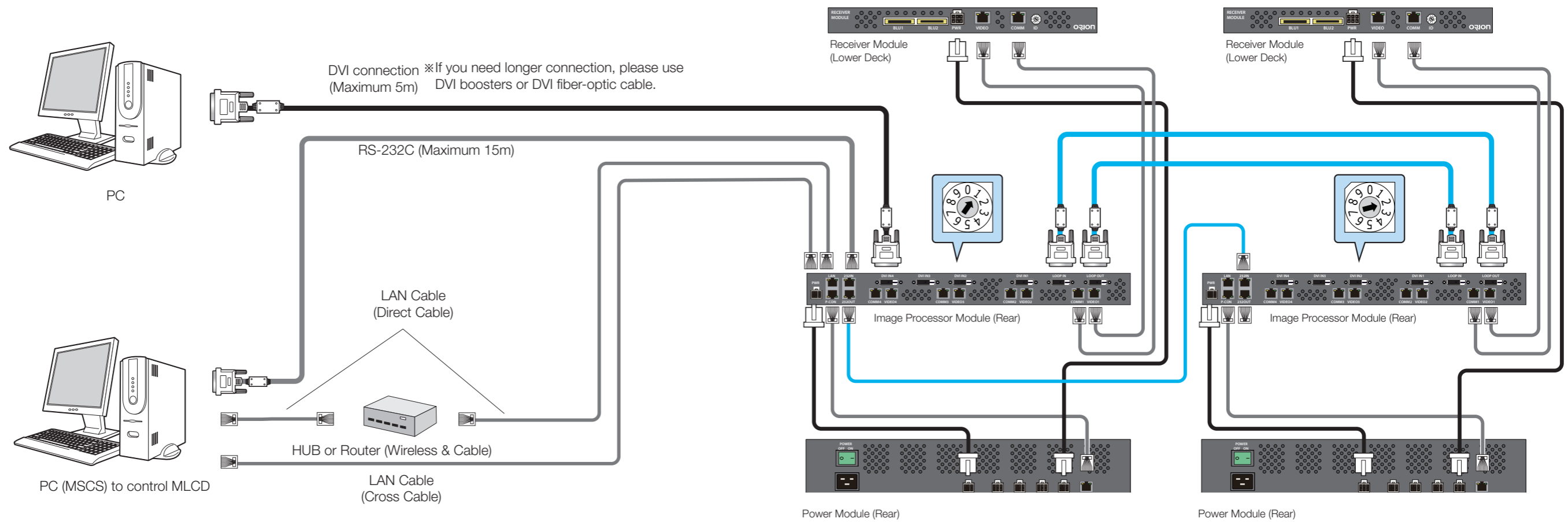
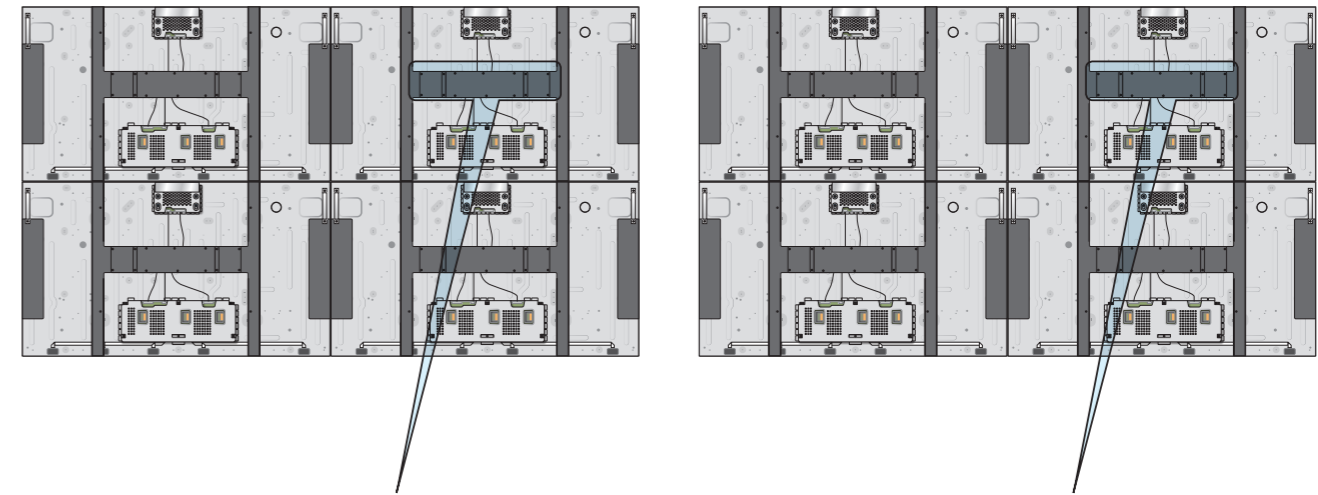

5. Setting and operation of MSCS software

5.1. MSCS Installation

- Insert the Installation CD.
- You can see following installation start screen.
- Select proper version for your product and start installation

• MSCS supports Windows® 2000, Windows® XP and Windows® Vista, Windows® 7™ only



MSCS Installation start screen.

※ MSCS Versions can be changed for function improvement without prior notice.



Caution for using MSCS

1. Data for Picture control, Manual Tracking and so forth can be read by clicking the right button of your mouse on the desired MLCD set from MSCS. Please do not use above function together with the other functions.
2. When you off AC power, execute power off by MSCS first and disconnect AC power to save your configuration.

5.2. Start MSCS

- MSCS is an application program needed to control MLCD.
- When you execute **MSCS (v X.X)** for your product at the installation screen, it will create a new folder at C:/Program File/MSCS (vX.X) and an icon on your computer screen.
- By double clicking the MSCS (v X.X) icon, the initial screen image of MSCS (v X.X) will be displayed as shown in the picture.

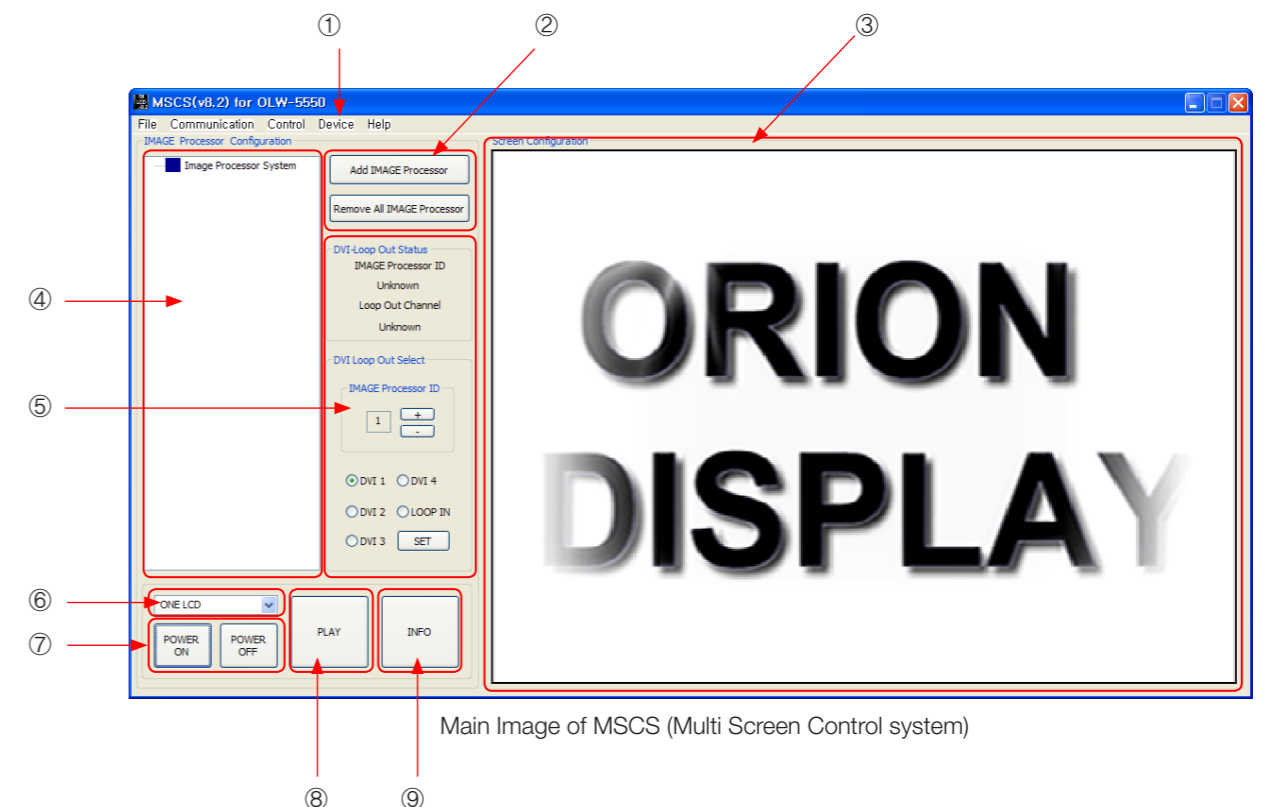

Main Image of MSCS (Multi Screen Control system)

- ① **Menu Bar**
- ② **Image Processor, Add/Remove button**
- ③ **Screen Configuration Window** : Window for configuration and checking the operating conditions.
- ④ **Tree View Window** : Show the Image Processor System.
- ⑤ **DVI Loop Out Status and Configuration Window**: Configure the input channel of Loop Out in the Image Processor or display the operating status.
- ⑥ **Command Mode Window**
- ⑦ **Power Mode Window** : Turn On/Off the display
- ⑧ **Play** : All the connected screens display 1:1 screen play from input channel.
- ⑨ **INFO** : Display the input information of the selected screen.

5.3. Control signal connections

5.3.1. Setting of COM Port

- Com Port connects or disconnects the communication between PC and MLCD.
- Connect MLCD to PC Com Port via RS-232C cable.

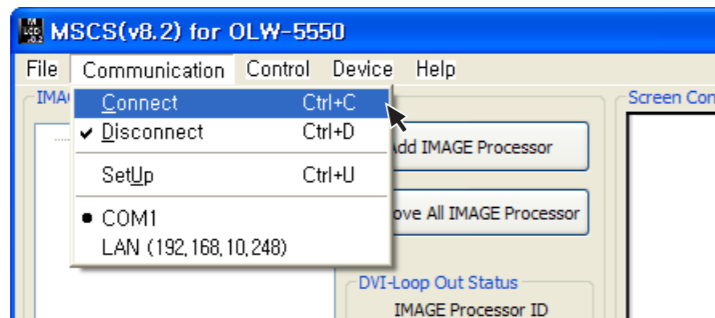

- Go to MSCS Menu -> Communication and set Com Port. Click '**Connect**' using mouse or press '**Ctrl+C**' using keyboard.
- In order to disconnect communication, click 'Disconnect' using mouse or press '**Ctrl+D**' using keyboard.

When you use USB-to-RS-232C converters, you need to set Com Port again, because MSCS uses one of Com Port no. 1 to 30.

※ Available Com Port on the PC is automatically recognized and displayed.

- Com Port Configuration

Baud Rate	115200bps(Fixed)
Data Bit	8Bits
Parity	None
Stop Bit	1Bit
Flow Control	None

5.3.2. Setting of LAN Port

1) In case of connecting to a LAN Hub

- This function is used to control the MLCD via LAN PORT.
- During the setting process, MLCD and control PC should be connected via RS-232C cable only. Do not connect ethernet cable.
- After setting process, the control PC should be connected to one of MLCD sets with Ethernet cable only. For the connection between the MLCD sets, they **should be connected with RS-232C cables**.

■ Network IP setting for MLCD

- 1) Execute the **LAN Configurator** from installation CD.
- 2) Select Com Port and select "**OPEN**".

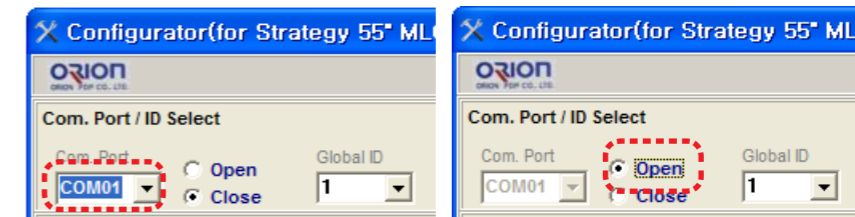

- 3) Select **ID of MLCD** which you want to control.

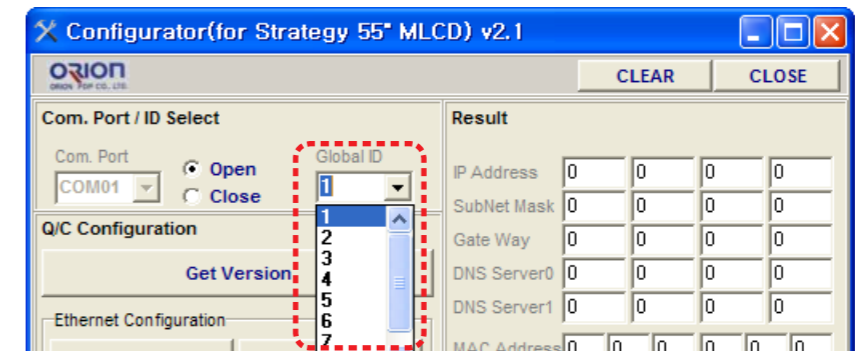

- 4) Input the authorized **IP address**.

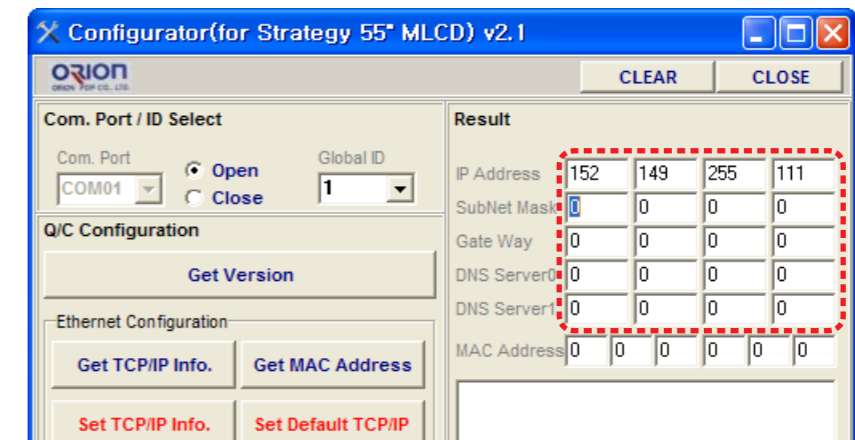

5) Click "SET TCP/IP Info." to save the IP address..

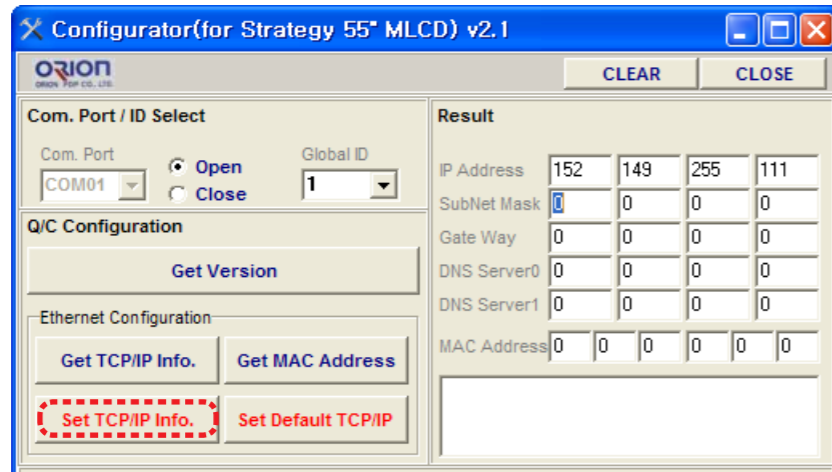

6) Click "GET TCP/IP Info." to check if the IP address is saved correctly.

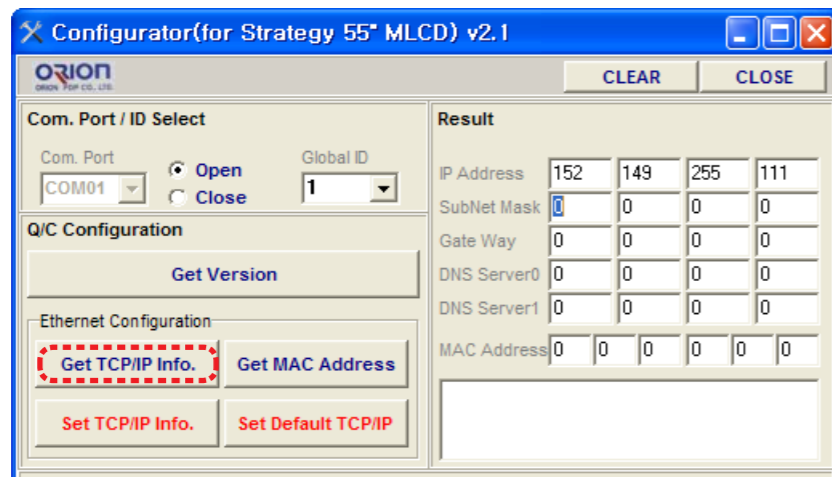

7) Close the LAN Configurator.

2) In case of connecting directly to user's computer

- Cross-LAN cable is required to connect.

■ Check the network informations

- 1) Execute the LAN Configurator from installation CD.
- 2) Select Com Port and select "OPEN".

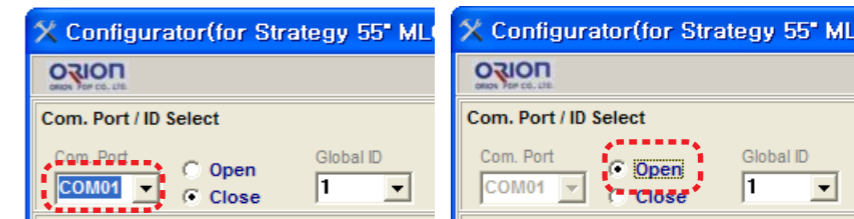

3) Select ID of MLCD which you want to control.

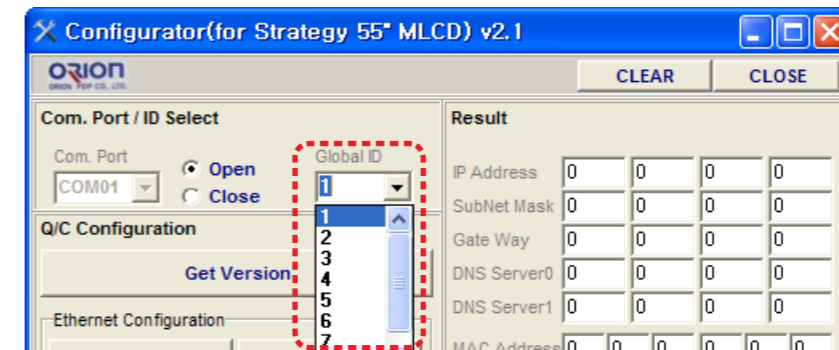

4) Click "GET TCP/IP Info." and check the network informations.

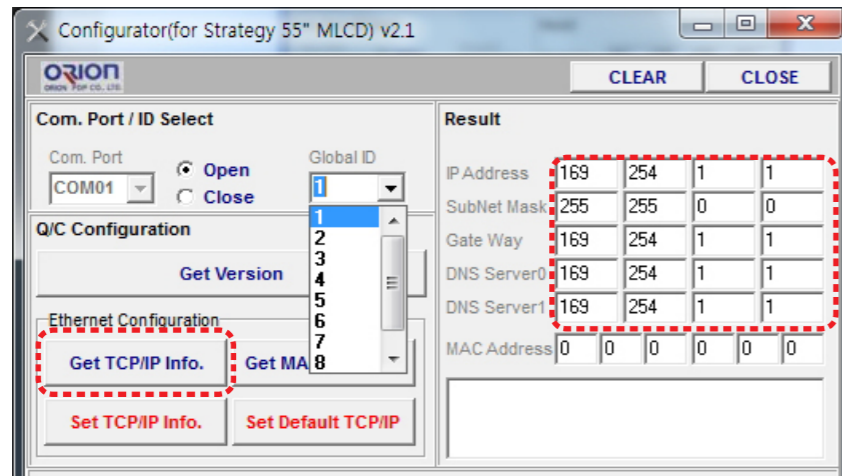

5) Input the network information of the user's PC to be identical with MLCD set. However, the final digit of the IP address must be different.

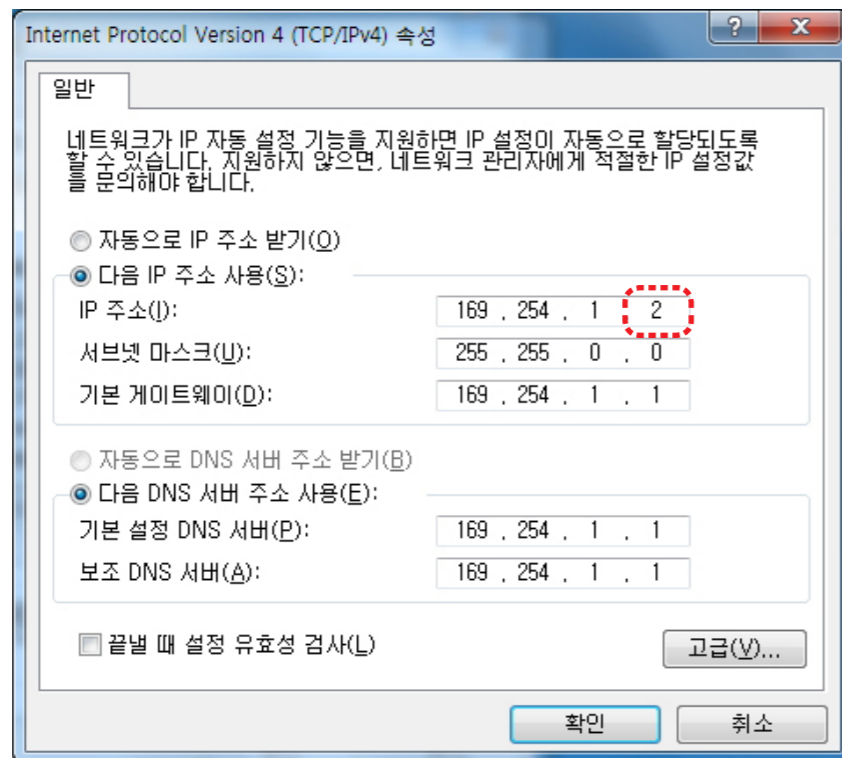

3) Network IP setting for MSCS

- 1) Execute the MSCS.
- 2) Select "Menu->Communication -> Setup" or "Ctrl+U" to start setup.

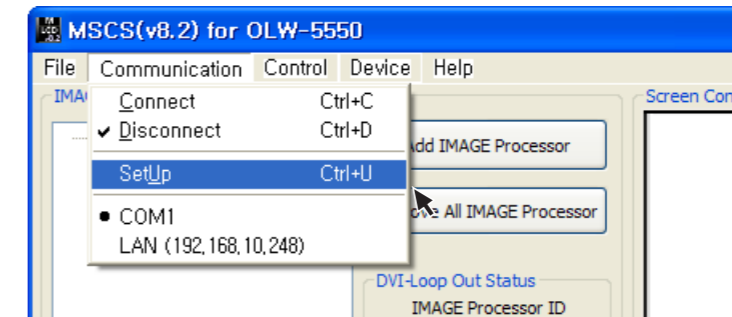

- 3) Select "Socket" radio button.
- 4) Type in IP Address of MLCD.
- 5) Click "Ping Test" to check status of communication.
- 6) Close the Communication setup window

● Menu Description

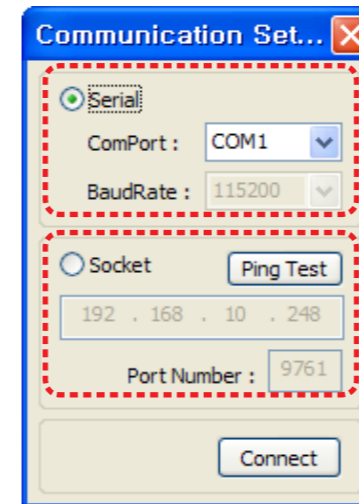

- **Serial** : Set the serial communication as a default communication.
- **Com Port** : Set the port of a PC to communicate with MLCD.
- **Baud Rate** : Fixed at 115200bps.
※ Caution: Users cannot change the Baud rate.
- **Socket** : Set the Ethernet LAN communication.
- **Edit Box** : Set the IP address.
- **Port Number** : Fixed as 9761.
※ Caution: Users cannot change the port number.
- **Ping Test**: Test the IP address.
- **Connect** : Connect the communication.

Communication Setup

5.4. "New design/Last design" setting

- You can see following pop-up window for "New design/Last design" when you click "Connect" or press "Ctrl+C" using keyboard after select communication type.

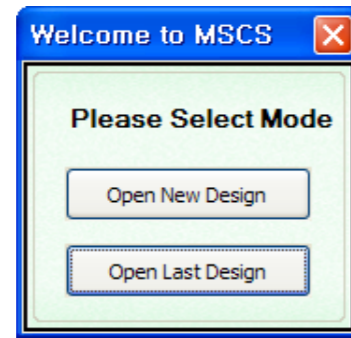

New/Last Design Set

- Click "Open New Design" to prepare new configuration.
- Click "Open Last Design" to go to last design before closing.
- When the connection is successfully completed after setting Com Port, following Message dialog is displayed. The dialog window will be disappeared in 1 second.

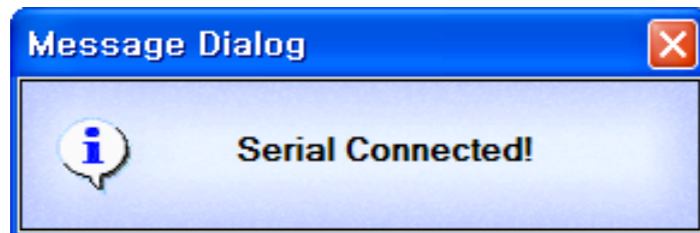

- When the connection is successfully completed after setting Lan Port, following Message dialog is displayed. The dialog window will be disappeared in 1 second.



5.5. Selecting the command transmission method

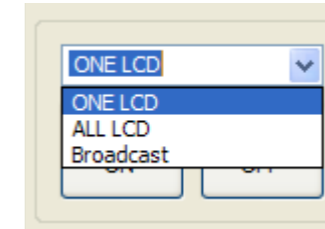

- ONE LCD** : Transmit Protocol Command to one MLCD.
- ALL LCD** : Transmit the Protocol command sequentially to all connected MLCD sets.
- Broadcast** : Transmit the Protocol command simultaneously to all connected MLCD sets.

5.6. Image Processor Configuration

- 1) Click **ADD IMAGE Processor button** according to the number of installed Image Processor. The input channel of Image Processor Module will be displayed at the View window.

You can find out the number of the currently connected Image Processor Module and input channel.(The number of controllable Image Processor is 9 and the maximum input channels are 45.)

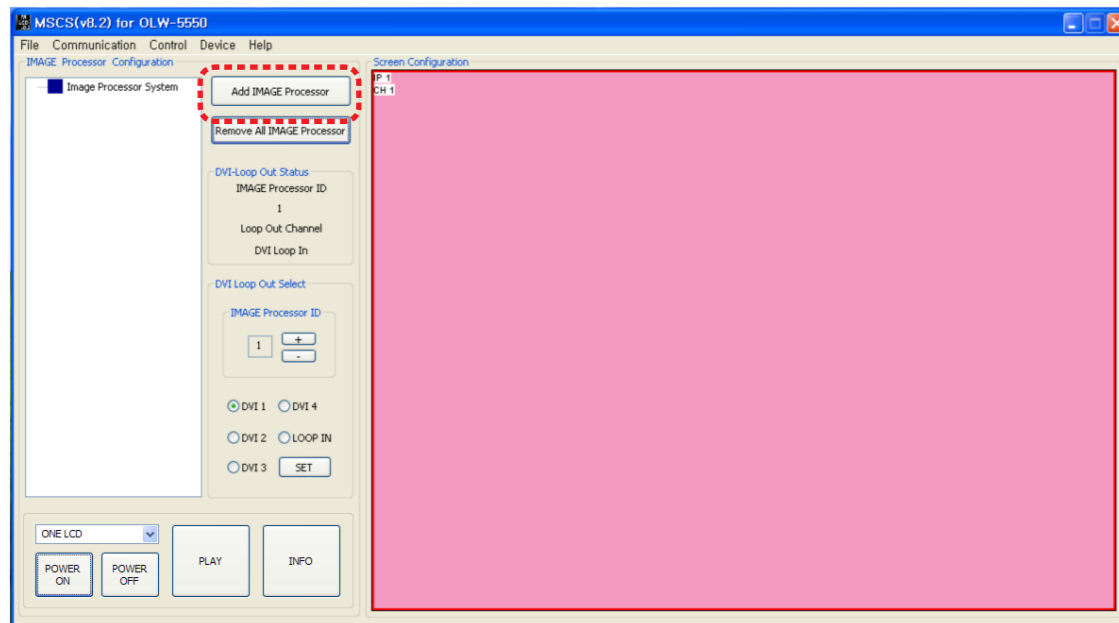

The current Input channel of the Image Processor Module is displayed in the Tree View window.

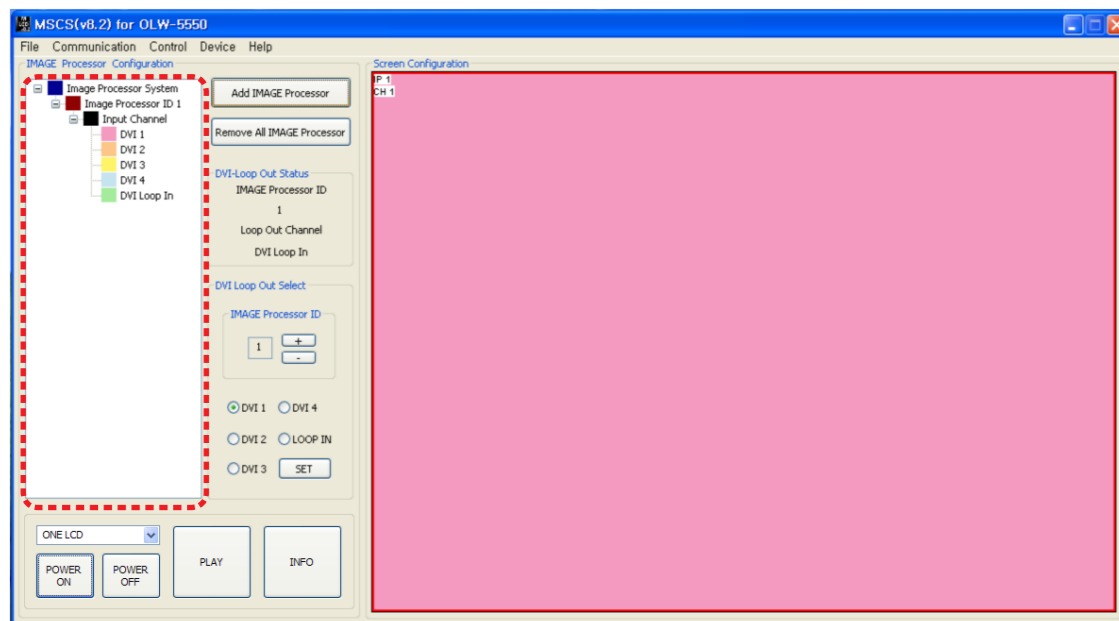

5.7. Multi Screen Configuration

- 1) Screen Configuration Dialog will pop up, when you Click **Image Processor ID Node** in the **Tree View window**.

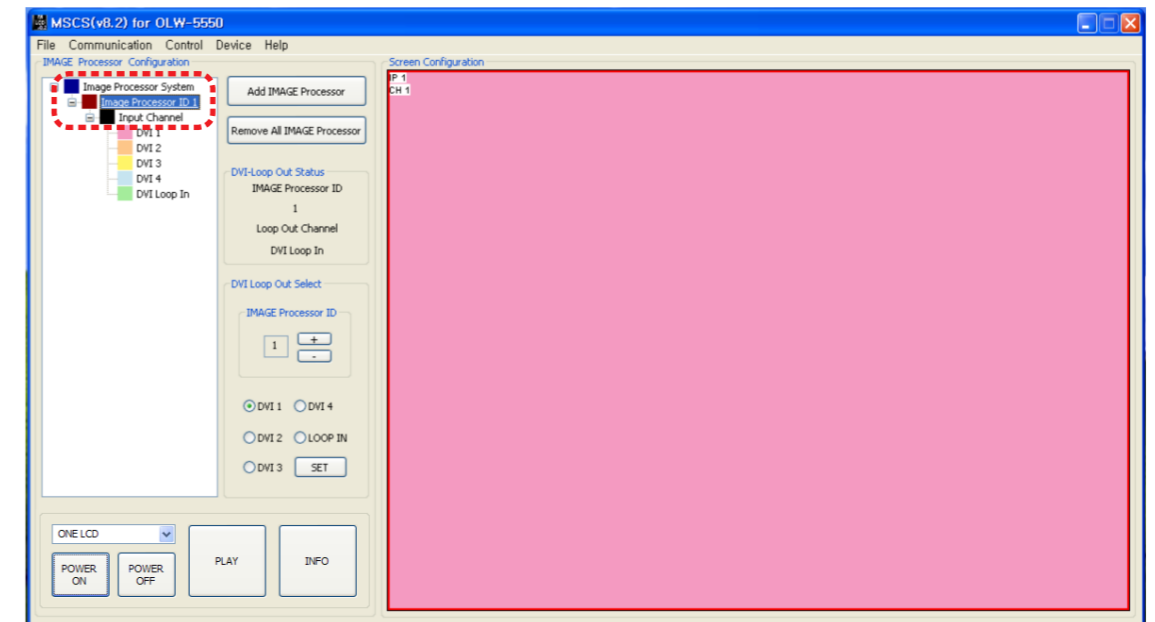

- 2) Screen formations can be selected by Screen Configuration Dialog.
- 3) The number of LCD set in the horizontal direction and vertical direction can be increased or decreased to make your selected screen formation. In case of 1X4 formation, the number of LCD set can be selected **1 to 9** horizontally, and **1 to 3** vertically.
- 4) In case of 2X2 formation, the number of LCD set can be selected **1 to 7** both horizontally and vertically.
- 5) In case of 1X4 formation, the number of LCD set can be selected **1 to 3** horizontally, and **1 to 9** vertically.

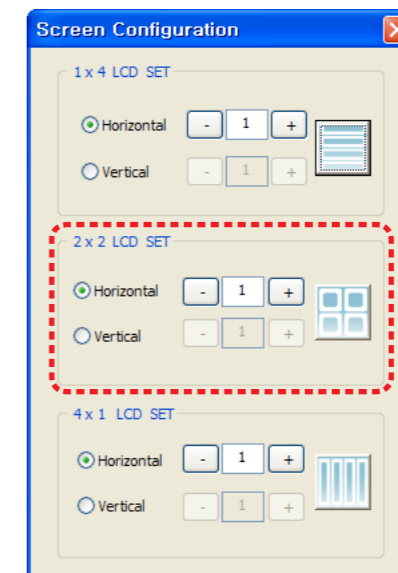

- 6) **Add Image Processor** : Click **Add Image Processor button**, each time one set of Image Processor Module is increased.
- 7) Then, the number of Image Processor Module and input channel will be displayed.

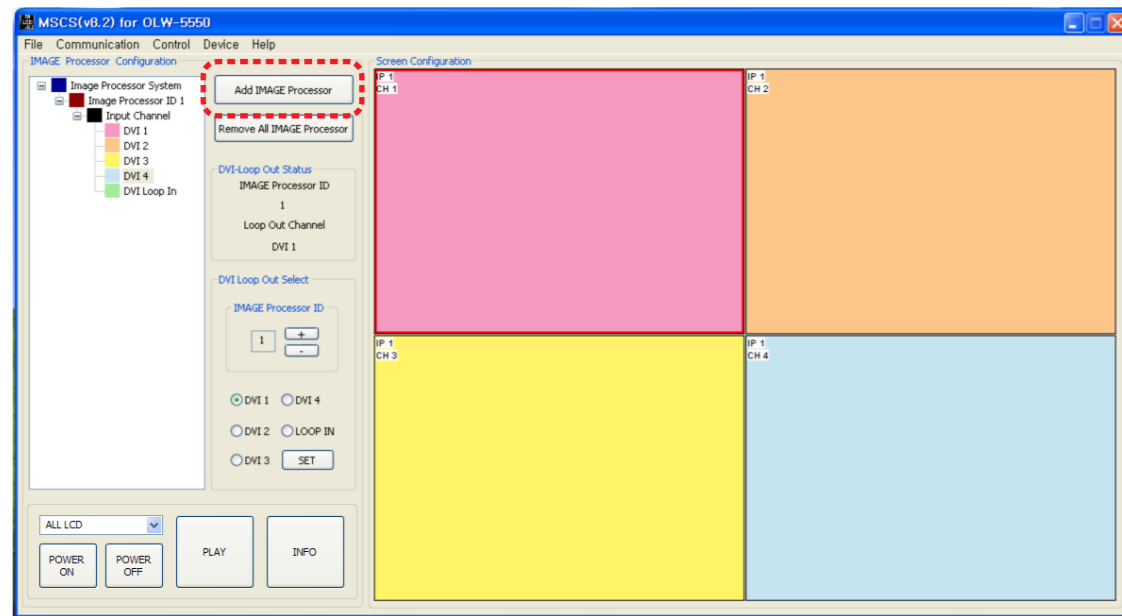

- 9) Select 2x2 LCD set formation in Screen Configuration Dialog and click +button to increase the number 1 to 2, and click  button, 4x2 LCD screen formation will be created at Screen Configuration.

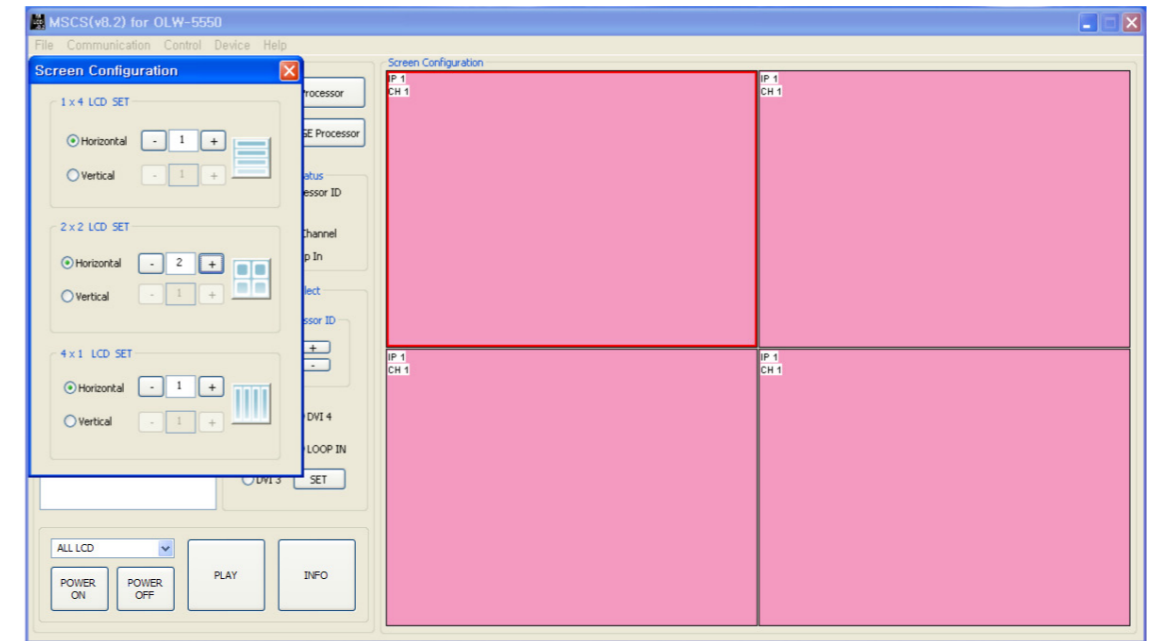

- 8) As you click **Add Image Processor button** again after one Image Processor Module is added, additional Image Processor Module is created as shown in the picture below.

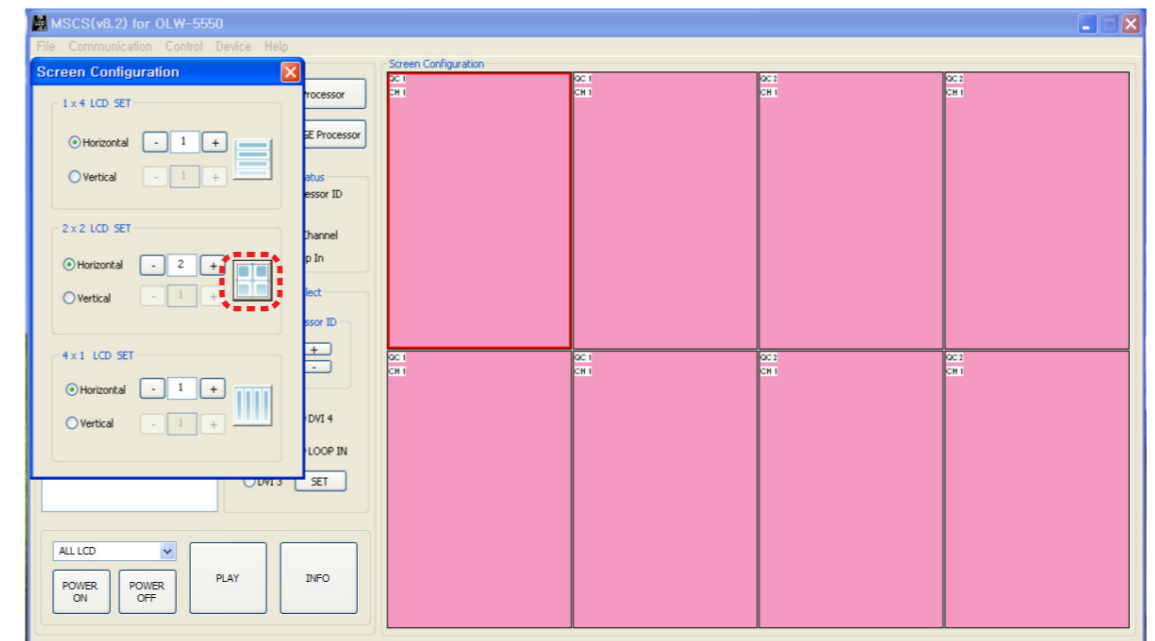
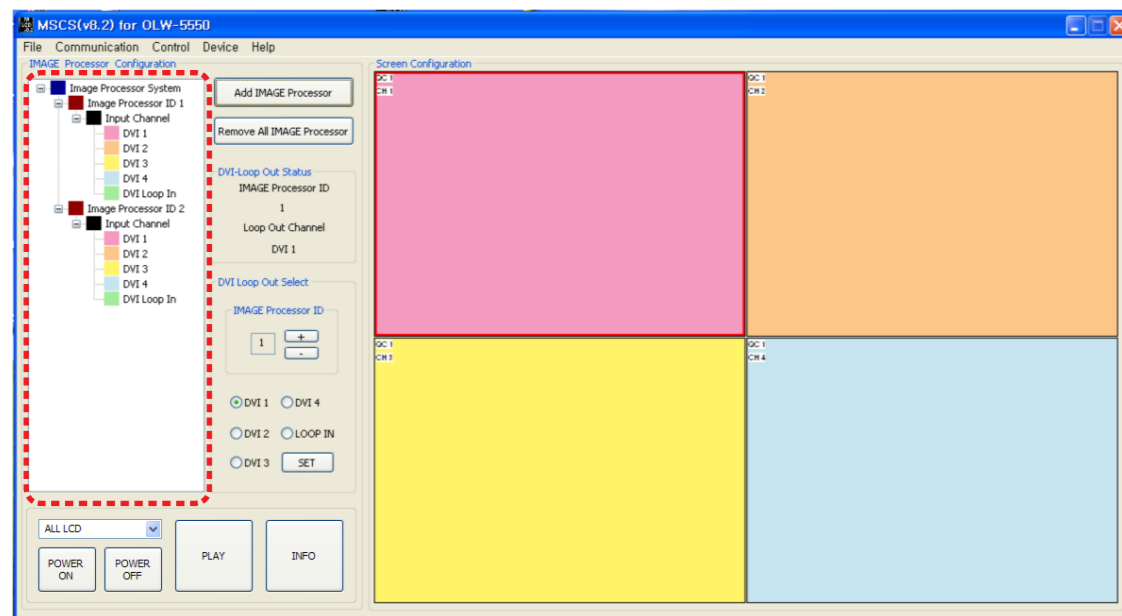

10) **Remove All IMAGE Processor** : If there are any changes in Image Processor Modules or you want to re-configure Image Processor Module, initialize Tree View window with Remove All IMAGE Processor button.

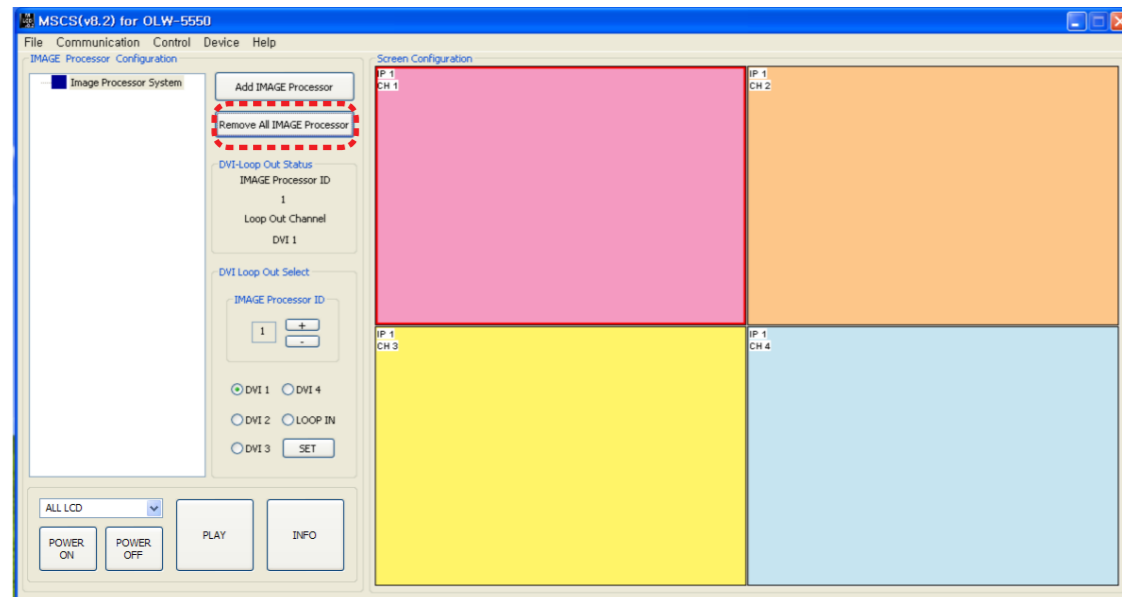
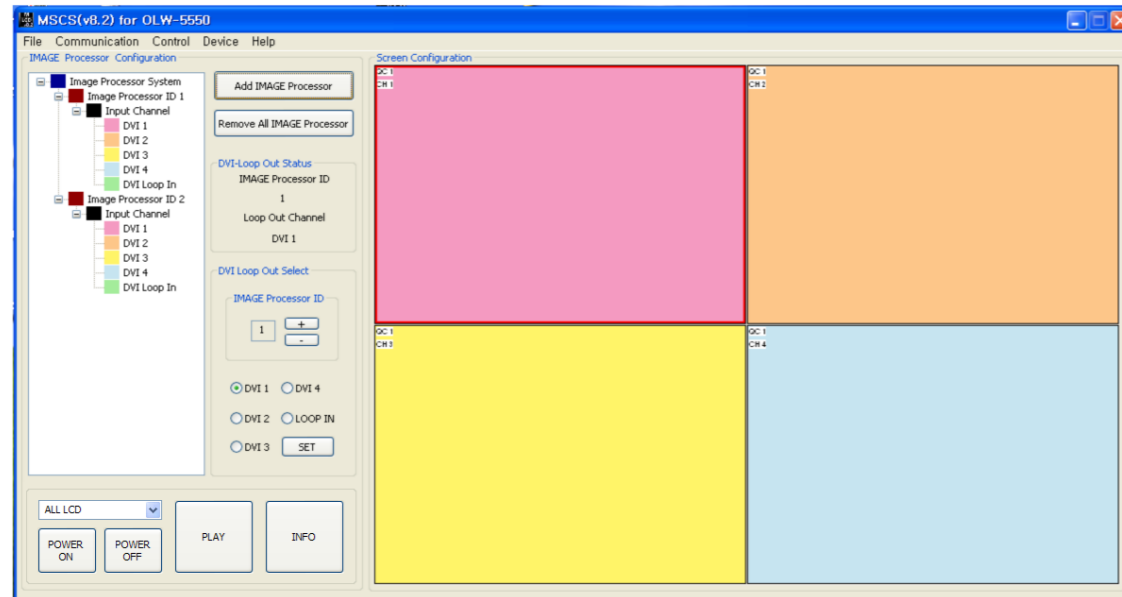

5.9. Power On/Off

1) Select **Broadcast** or **ALL LCD** for command transmission method and click **POWER ON**.
All connected devices will be turned on.

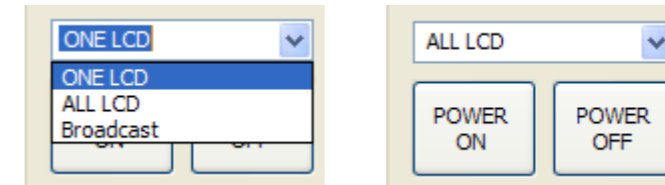

Caution Unexpected momentary power cut may cause malfunction. If you have the malfunction from power cut, unplug the power cord and plug it again at least 1 minute later.

5.8. Input Channel Change

5.8.1. Play button

- e.g.) select DVI 2

- 1) Select the input **channel source** of your choice at the Input Channel in **Tree View window**.
- 2) The selected input source will be displayed at the all screens by clicking **Play button**. Image Processor ID and the Input Channel will be displayed on the screen of MSCS.

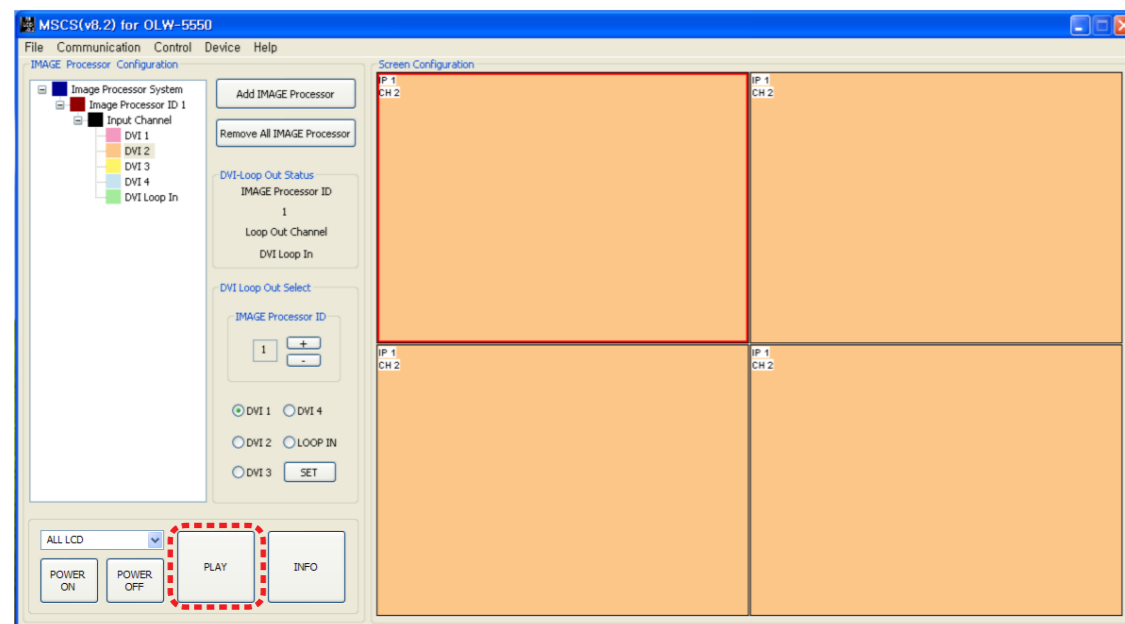
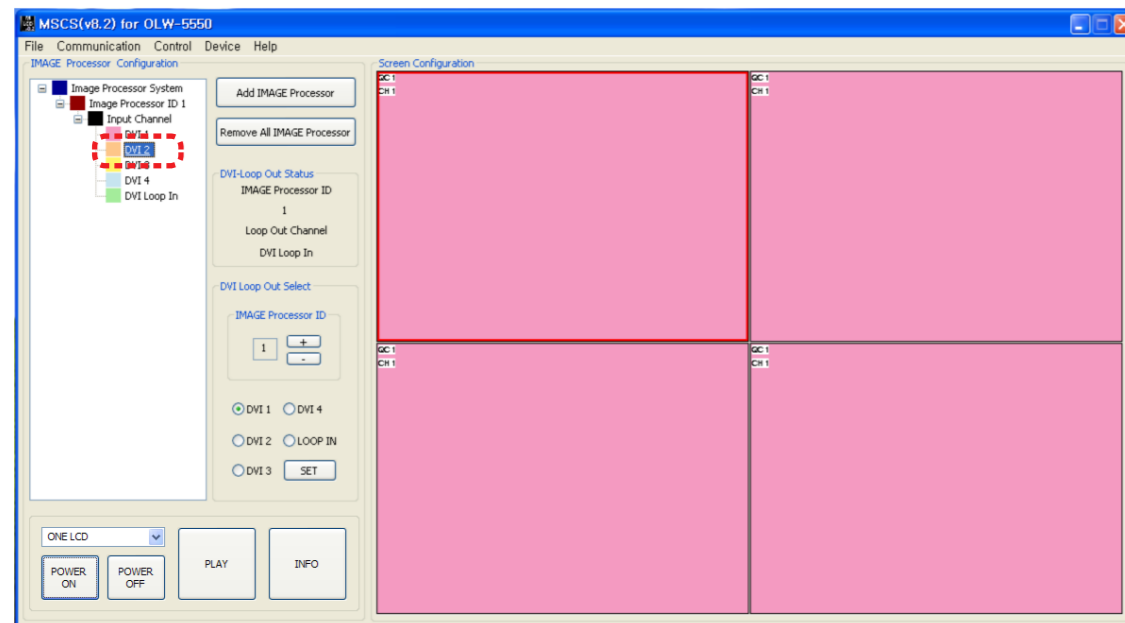

5.8.2. Mouse (left button use)

- e.g.) select DVI 3

- 1) Select the input **channel source** of your choice at the Input Channel in **Tree View window**.
- 2) The selected input source will be displayed at the all screens by clicking the left **button of the mouse**. Image Processor ID and the Input Channel will be displayed on the screen of MSCS.

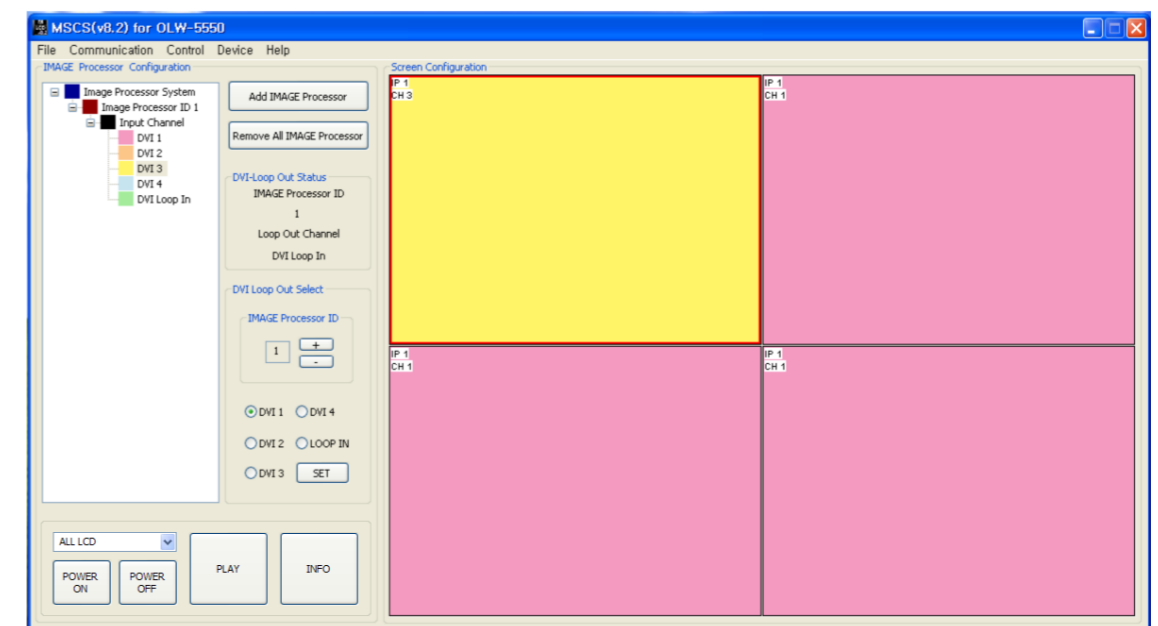
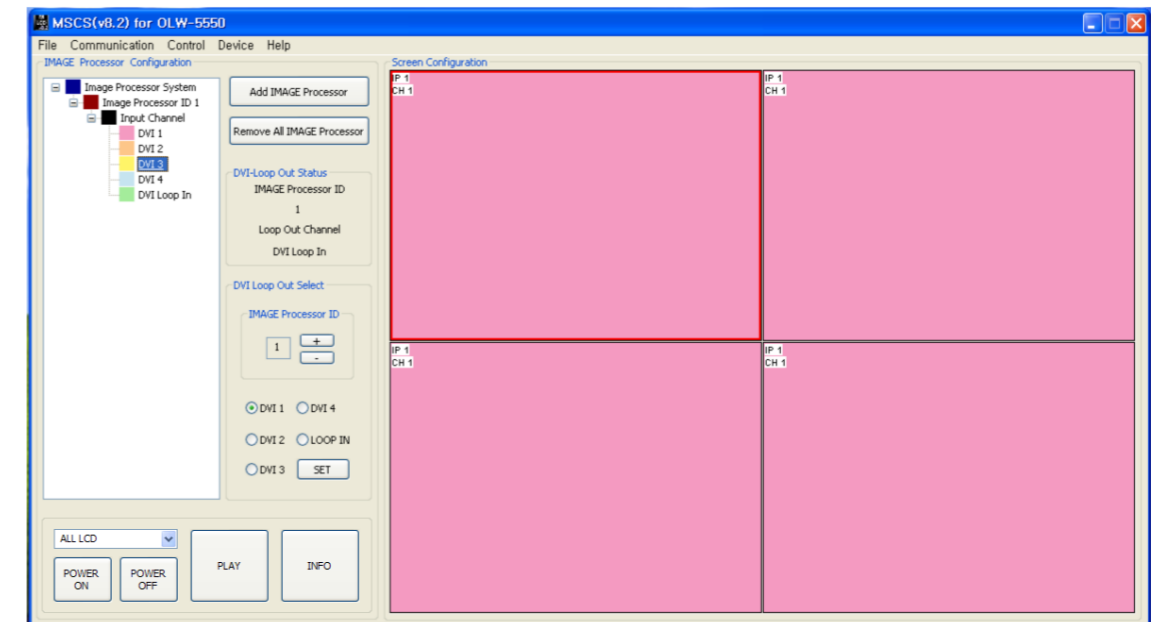

5.8.3. Mouse Drag & Drop

- Select the input channel source of your choice at the Input Channel in Tree View window.
 - e.g.) select DVI 2
- 1) Click the **selected screen** with the **left button** and drag.
- 2) The screen will be converted to **DVI 2** as soon as you **release the button**.

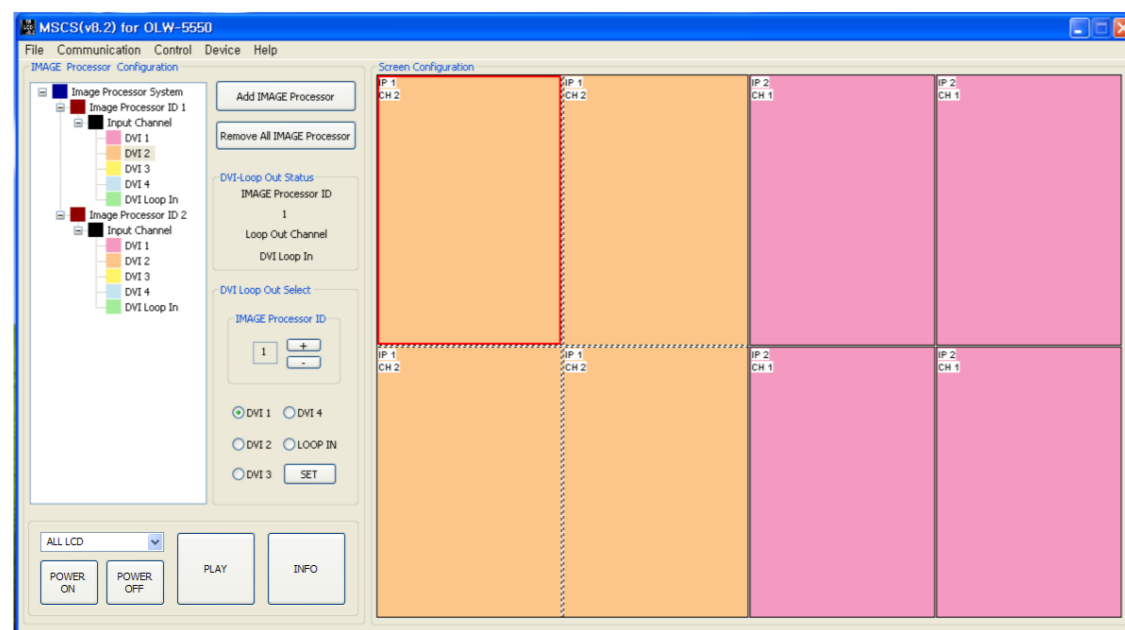
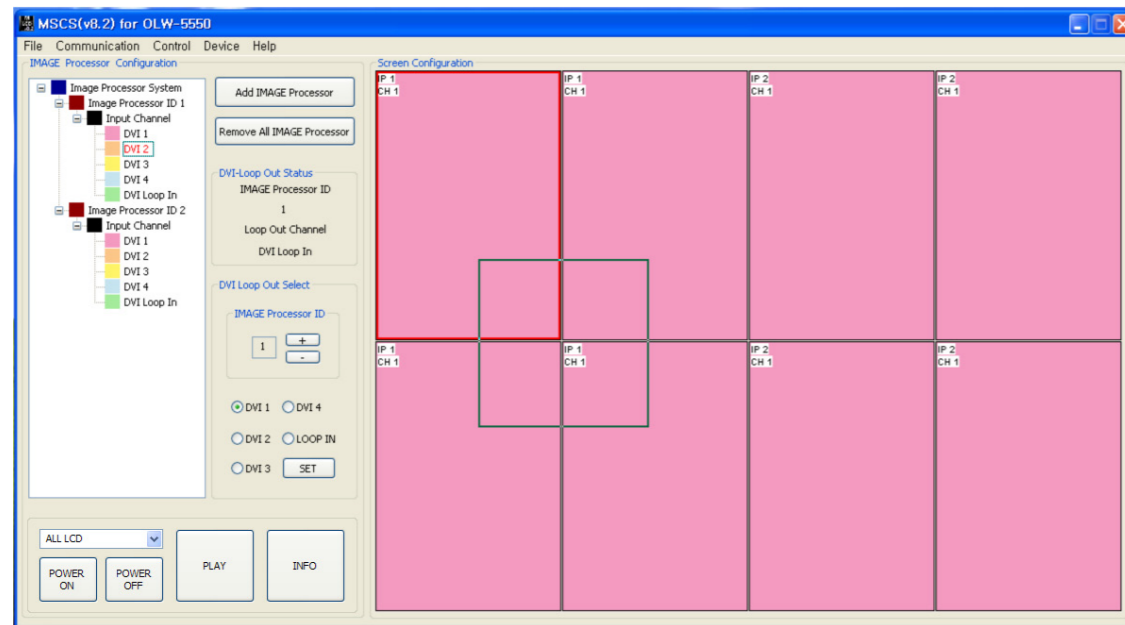

5.10. Loop Out (Daisy-Chain Out) Channel Configuration

- Configure the channel for Loop Out (Daisy-Chain Out)
 - e.g.) **Selecting Loop Out Channel DVI 3 for Image Processor Module ID 1**

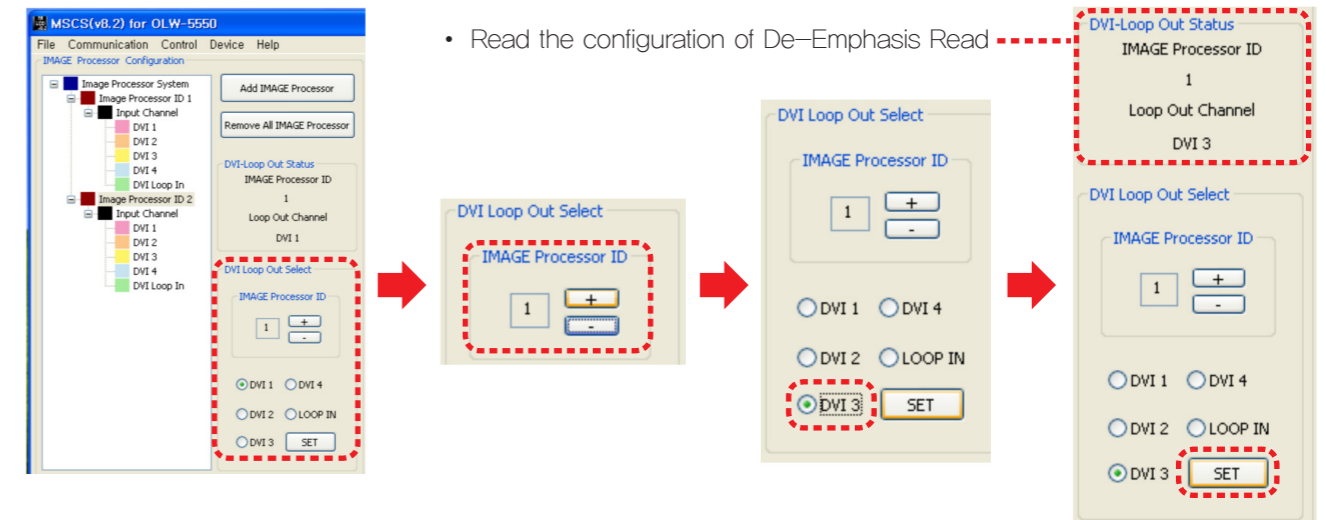

• Read the configuration of De-Emphasis Read

- 1) Select the ID number of Image Processor Module to make Loop Out Channel. Click **+ button** and **- button** to increase or decrease the number. The numbers for Image Processor ID are available from **1 to 9**.
- 2) Select the DVI channel you want and Click **Set button** (DVI1, 2, 3, 4, Loop In Channel).
- 3) The information for Image Processor Module ID and Loop Out Channel will be displayed at the Status widow.
- 4) The Loop Out Status for the connected Module can be checked by clicking the **right button** of the mouse.

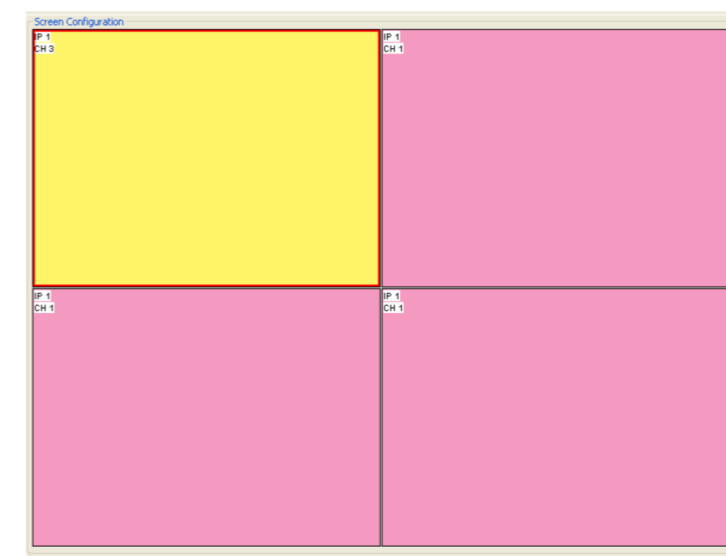

5.11. Slide Show

- Display the screens formats saved by users sequentially.
- Select Menu -> Control -> Slide Control or press 'Ctrl+S' keys in the keyboard to start slide show.

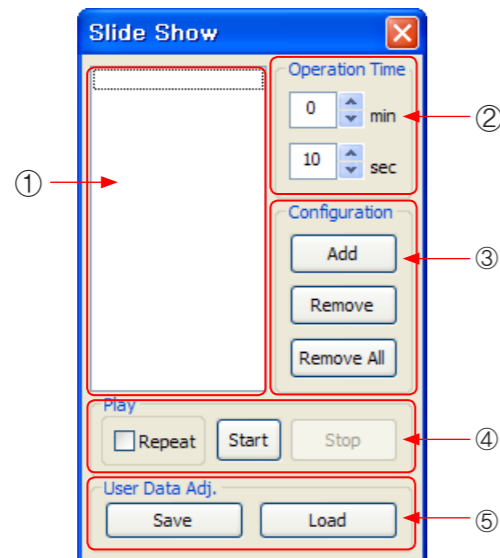
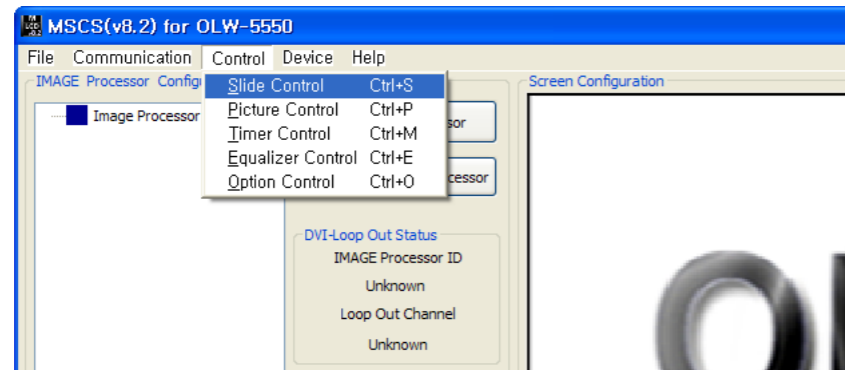

- ①. **Slide Show Status Window** : Display the Slide Show Configuration.
- ②. **Operation Time** : Set the duration time for each screen format of the Slide Show.
- ③. **Configuration** : Add or delete the screen format for the Slide Show.
- ④. **Play** : - Repeat : Repeat the Slide Show.
- Start : Start the Slide Show.
- Stop : Stop the Slide Show.
- ⑤. **User Data Adj.** : Save or load the Slide Show.

1) Create the screen format of your choice.

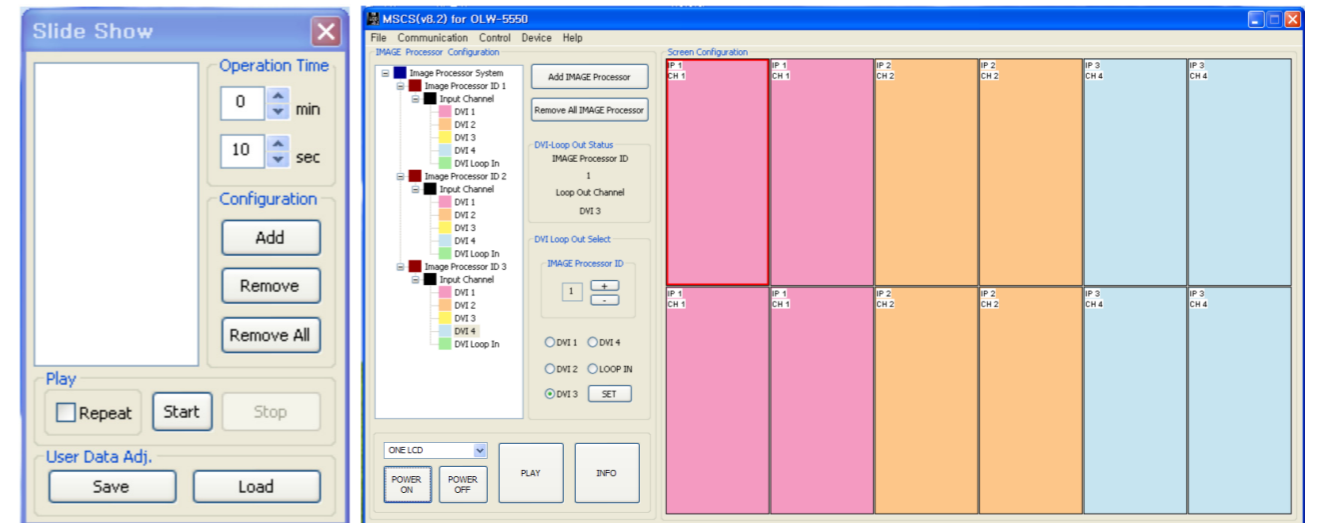

2) Set the operation time (10 seconds ~ 1 hour)

- "Operation Time" can be set from 10 seconds up to 1 hour.
- Save the screen format by clicking **Add** button.

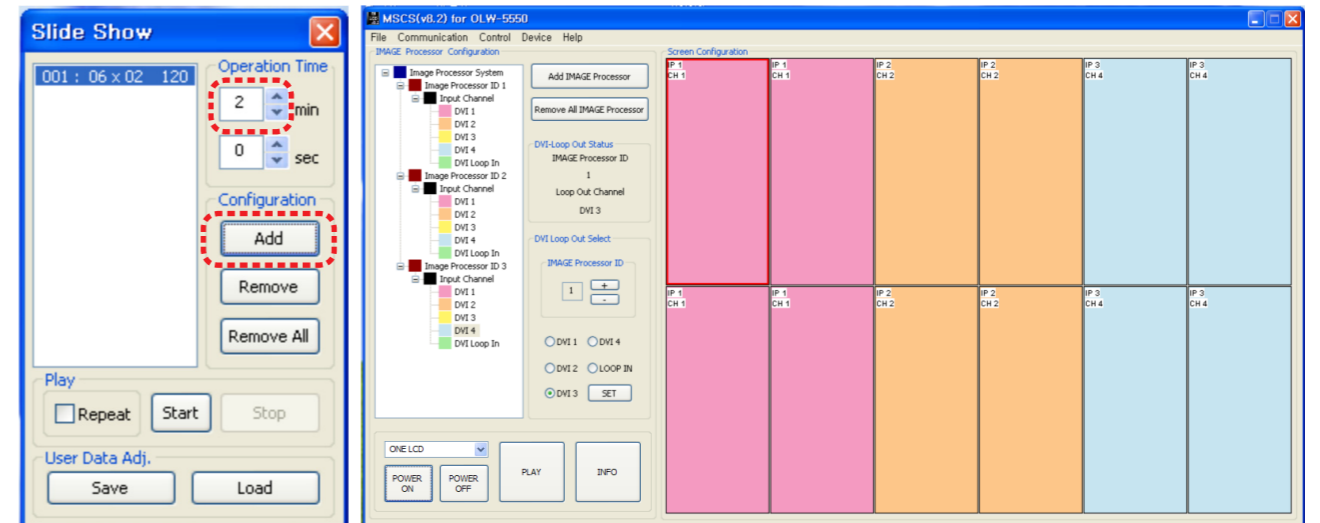

3) Configure various screen format in the same manner.

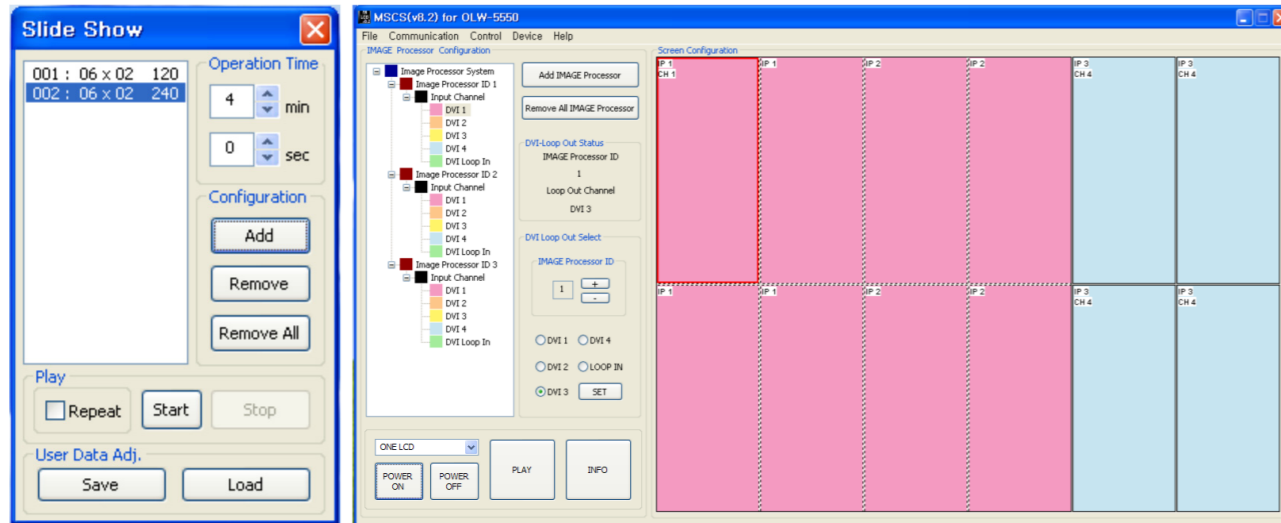

4) Click **Start button** after screen configuration. Screen formats are displayed according to the configured time and sequence.

- The screen formats of Slide Show are displayed only for scheduled time.

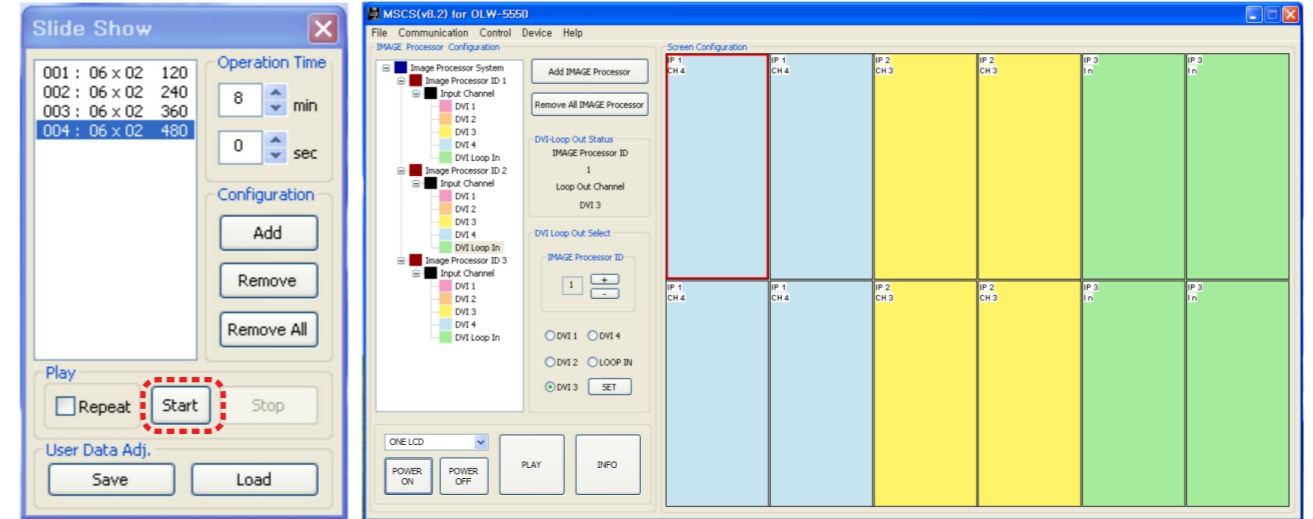

5) To repeat the configured screen format, click **Repeat button**.

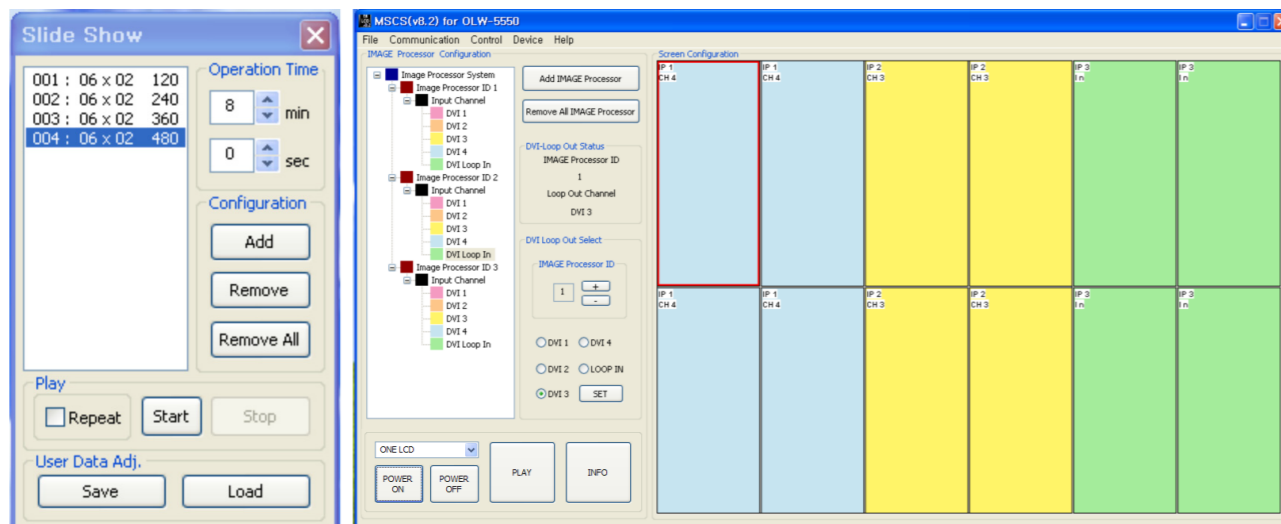
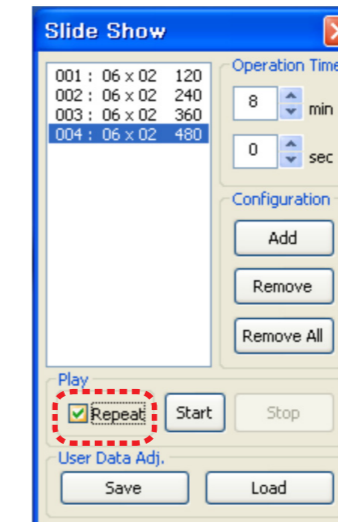
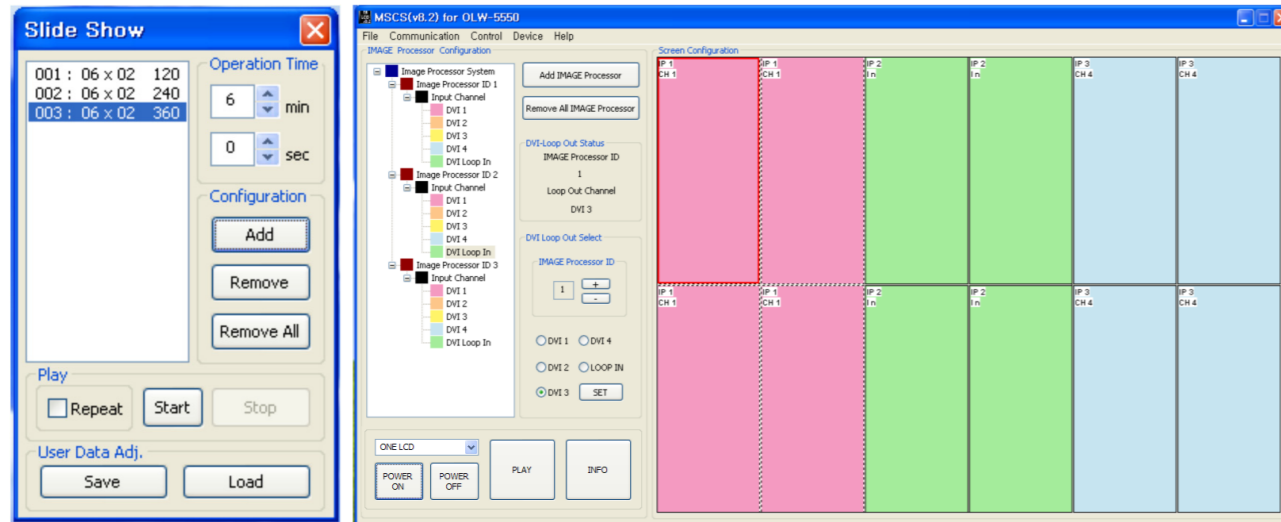

6) Click **"Stop"** button to end "Slide Control"

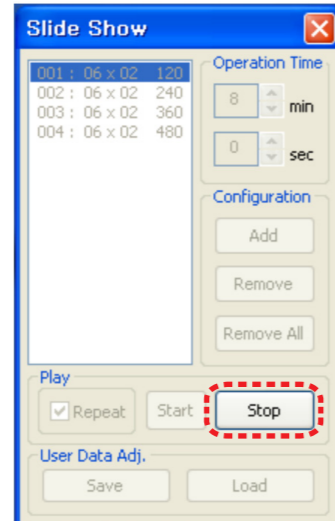

7) Save or Load the slide configuration.

- Click **"SAVE"** button to save user added Slide configuration as **"*.ssd"** file.
- Click **"LOAD"** button to open saved **"*.ssd"** file.

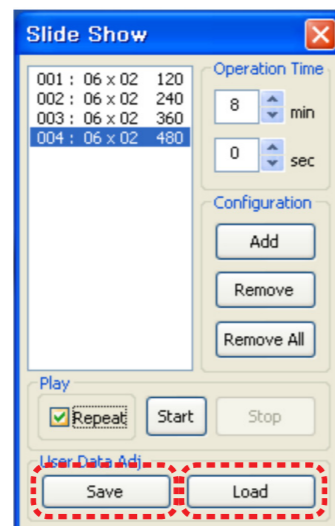

5.12. Picture Control

- Register values related to display of MLCD can be changed.
- To use Picture Control, go to MSCS Menu -> Control -> Picture Control or press **"Ctrl+P"** using Keyboard.

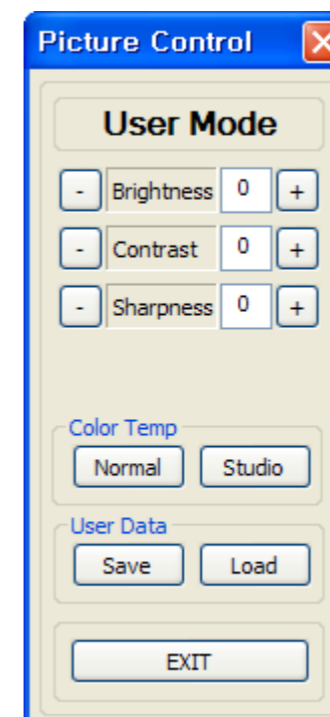
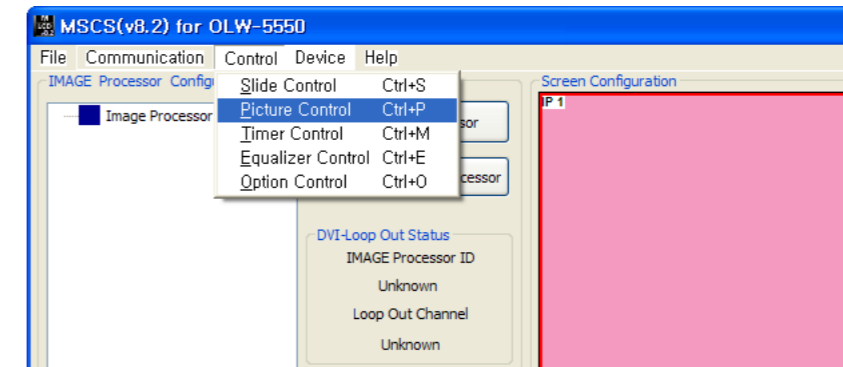

- In order to control display values, input values directly in **"Edit Box"** and press **Enter key**. Or click **-/+ button** using mouse.
- Click **"Exit"** button or press **"Ctrl+X"** using keyboard to close "Picture Control" window.
- **Color Temp** : Change the color temperature of the screen.
 - Normal : Initial setting. Proper for normal video image view.
 - Studio : Low Color temperature. Proper for broadcasting purpose.
- **Brightness** : The range of "Brightness" you can adjust is 0 to 100.
- **Contrast** : The range of "Contrast" you can adjust is 0 to 100.
- **Sharpness** : The range of "Sharpness" you can adjust is 0 to 28.
- **User Data** : Users can adjust color impression with white screen and save or load the adjusted value.
 - Save : Save User's data file (*.pdt)
 - Load : Load User's data file (*.pdt)

5.13. Timer Control

- Users can set the time for turn on or turn off.
- To use this function, click Menu -> Control-> Timer Control or use '**Ctrl +M**' keys from the keyboard.

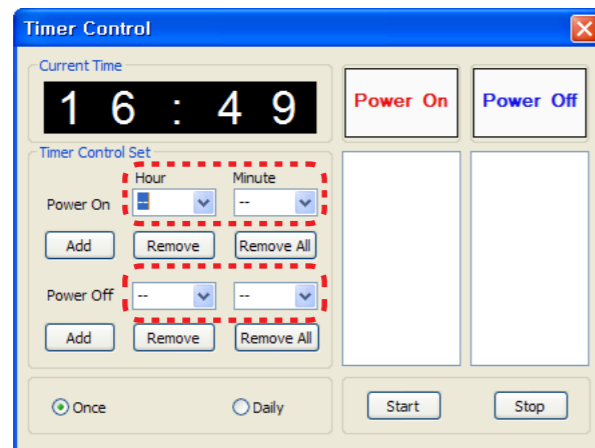
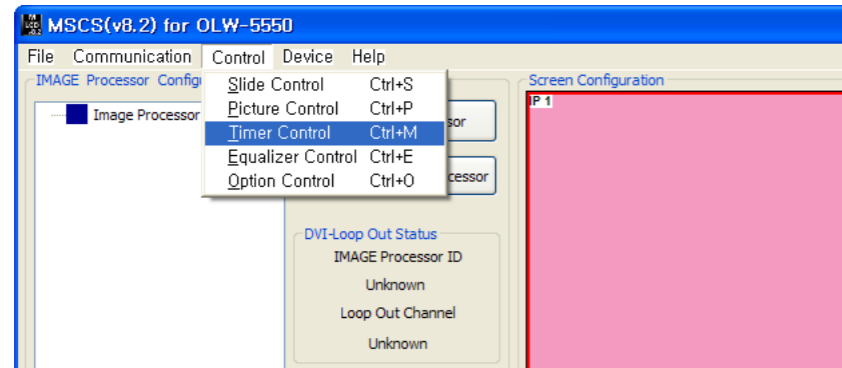

Timer Control Dialog

- How to set the time of **power on or off**.
 - Select Hour and Minutes of turn on or off
 - After setting Power On/Off time, click **“Add”** button to add it to Power On/Off List Box. You can save up to 10 settings for Power On/Off. Also, you can delete the saved settings in the List Box one by one with **“Remove”** button. If you delete all the settings, click **“Remove All”** button.
 - Select **once** for one time use and Daily for daily use, then click **'Start'**
 - Power on or off** signal will be transmitted to MLCD at the time of user set.
- **Time Dialog** must be activated to use Timer function.

5.14. Equalizer Control

- You can control the Equalizer for more stable image quality according to the length of the image signal cable.
- Click Menu -> Control-> Equalizer Control or press "**Ctrl + E**" to use Equalizer Control Dialog

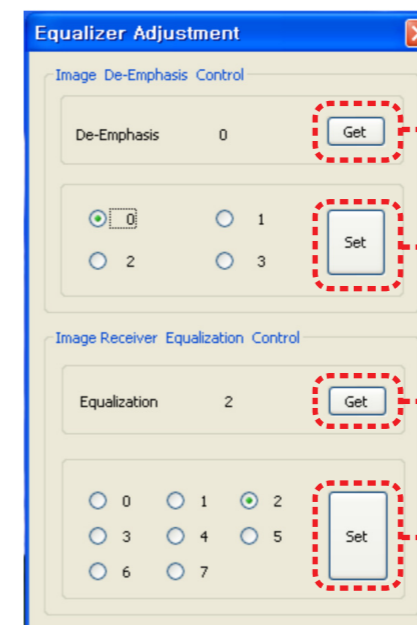
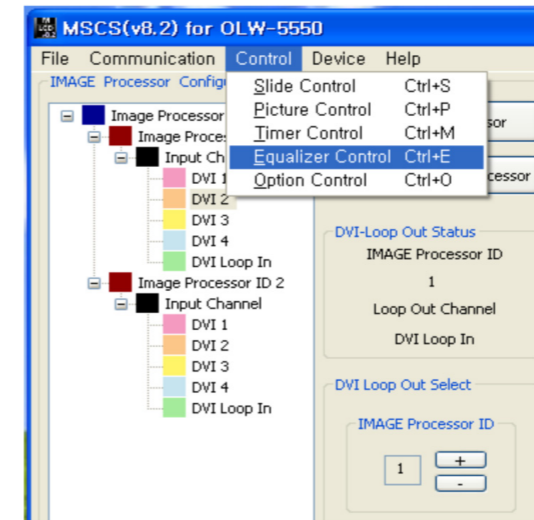

• Read the configuration of DVI Loop Out.

• Configure De-Emphasis.

• Read Equalization value.

• Configure the Equalizer

- Image De-Emphasis Control(IP Board in Image Processor Module) compensates output signal loss and Image Receiver Equalization Control(Image Receiver Board) compensates input signal loss.
- The default value of Image De-Emphasis Control is 0 and its compensation value is 0dB. If it is set as 1, the compensation value is -3dB, and 2 for -9dB.

Recommended Image Receiver Equalization Control Value

- For STP Cable

Format (Data Rate)	0~10 m	Over 10m
1080P (1.65Gbps)	0 ~ 1	2 ~ 6

- For UTP Cable

Format (Data Rate)	0~10 m	Over 10m
1080P (1.65Gbps)	0 ~ 1	2 ~ 5

5.15. Option Control

- There are various optional functions for convenient use.
- Click Menu -> Control-> Option Control or press "Ctrl+M" keys to use Option Control Dialog.

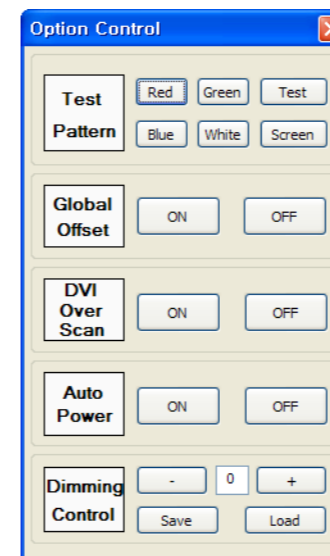
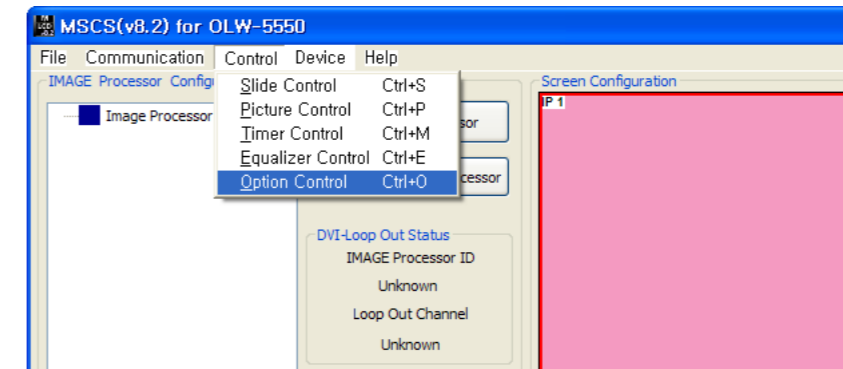

- Test Pattern** : Display the embedded patterns on the screen.
 - Pattern : 4 Patterns are embedded (Red, Green ,Blue, White, Test)
 - Screen : Return to the input source
- Global Offset** : The images on the seam area between the screens can be displayed on the screen or omitted from the screen. It can be selected to improve the continuity of the images.
- DVI Over Scan** : DVI Over Scan : Over Scan can be used for DTV resolution.
- Auto Power** : The system, LCD screens and driving Modules, can be turned on automatically with the connection of AC power.
- Dimming Control** : The brightness of LCD backlight can be adjusted. The adjusted vales can be saved and re-loaded.

5.16. ORION Homepage log on and Version Information

- In order to move to Orion website, go to "Help" of menu bar ->"OrionDisplay HomePage".

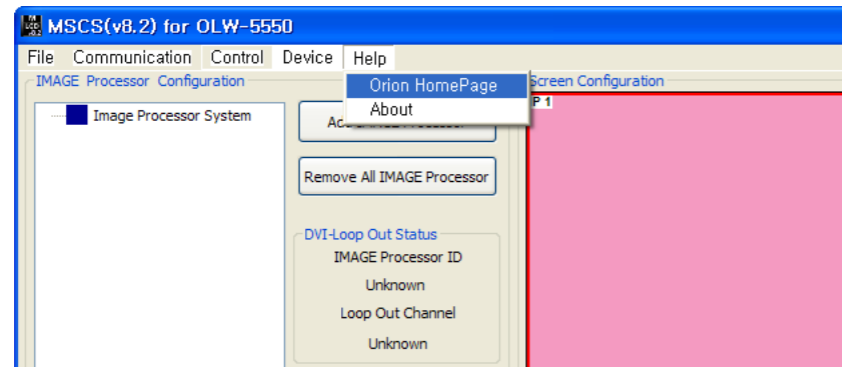

ORION Homepage Log on

- Go to "Help" of menu bar -> "About" to check MSCS.

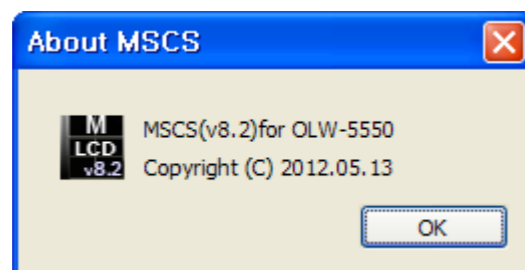
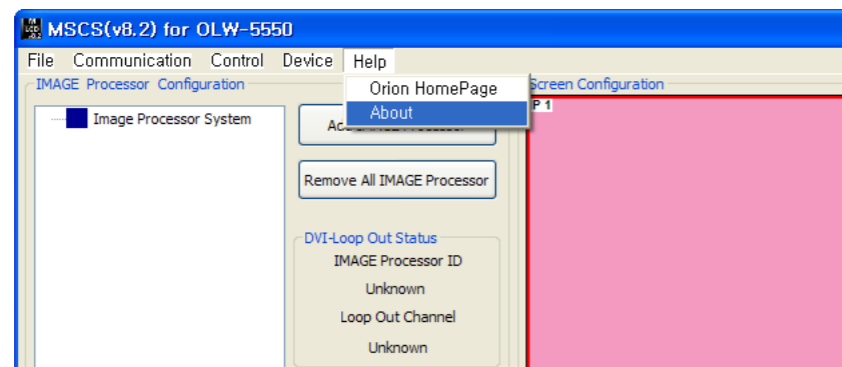

Checking MSCS Version

6. MSCS Protocol

- PWR : Power Supply Board
- IP : Image Processor Board
- IC: Image Control Board
- IR : Image Receiver Board

1. Power On

A. General Command

	STX	CMD	LENGTH	Data		Check sum	ETX
				ID(1Byte)			
				Image Processor Module ID	IP ID		
Value	0X02	0X40	0X01	Variable	Variable	Variable	0x03

- Send To MLC D
- CMD : 0x40

- ID Range (0x11~0x94): Upper Byte is Image Processor Module Set ID(1~9) and Lower Byte is the ID of IP Board(1~4). In case of 4 LCD sets, IDs will be 0x11, 0x12, 0x13, and 0x14.
- Check Sum : Add values from STX to Data and execute logical operation "NOT."

B. Broadcast Command

	STX	CMD	LENGTH	Data		Check sum	ETX
				ID(1Byte)			
				Image Processor Module ID	IP ID		
Value	0X02	0X40	0X01	0x00		Variable	0x03

- Send To MLC D
- Send the same command for all MLC D. No response will be made.

- Receive Data

	STX	CMD	LENGTH	Data		Check sum	ETX
				ID(1Byte)			
				Image Processor Module ID	IP ID		
Value	0X02	0X40	0X01	Variable	Variable	Variable	0x03

- ID Range (0x11~0x94): Upper Byte is Image Processor Module Set ID(1~9) and Lower Byte is the ID of IP Board(1~4). In case of 4 LCD sets, IDs will be 0x11, 0x12, 0x13, and 0x14.
- Check Sum : Add values from STX to Data and execute logical operation "NOT."

2. Power Off

A. General Command

	STX	CMD	LENGTH	Data		Check sum	ETX
				ID(1Byte)			
				Image Processor Module ID	IP ID		
Value	0X02	0X41	0X01	Variable	Variable	Variable	0x03

- Send To MLCD
- CMD : 0x41

- ID Range (0x11~0x94): Upper Byte is Image Processor Module Set ID(1~9) and Lower Byte is the ID of IP Board(1~4.) In case of 4 LCD sets, IDs will be 0x11, 0x12, 0x13, and 0x14.
- Check Sum : Add values from STX to Data and execute logical operation "NOT."

B. Broadcast Command

Value	STX	CMD	LENGTH	Data			Check sum	ETX
				ID(1Byte)		Master		
				Image Processor Module ID	IP ID			
0x00	0X02	0X41	0X01	0x00	0x00	0x01	Variable	0x03

- Send To MLCD

- Send the same command for all MLCD. No response will be made.

- Receive Data

Value	STX	CMD	LENGTH	Data			Check sum	ETX
				ID(1Byte)		Master		
				Image Processor Module ID	IP ID			
Variable	0X02	0X41	0X01	Variable	Variable	0x01	Variable	0x03

- ID Range (0x11~0x94): Upper Byte is Image Processor Module Set ID(1~9) and Lower Byte is the ID of IP Board(1~4.) In case of 4 LCD sets, IDs will be 0x11, 0x12, 0x13, and 0x14.
- Check Sum : Add values from STX to Data and execute logical operation "NOT."

3. Information

- Display the information on the LCD screen.

A. General Command

Value	STX	CMD	LENGTH	Data			Check sum	ETX
				ID(1Byte)		Master		
				Image Processor Module ID	IP ID			
0x00	0X02	0X42	0X02	Variable	Variable	0x01	Variable	0x03

- Send To MLCD

- CMD : 0x42

- ID Range (0x11~0x94): Upper Byte is Image Processor Module Set ID(1~9) and Lower Byte is the ID of IP Board(1~4.) In case of 4 LCD sets, IDs will be 0x11, 0x12, 0x13, and 0x14.
- Check Sum : Add values from STX to Data and execute logical operation "NOT."

B. Broadcast Command

Value	STX	CMD	LENGTH	Data			Check sum	ETX
				ID(1Byte)		Master		
				Image Processor Module ID	IP ID			
0x00	0X02	0x42	0X01	0x00	0x00	0x01	Variable	0x03

- Send To MLCD

- Send the same command for all MLCD. No response will be made.

- Receive Data

Value	STX	CMD	LENGTH	Data			Check sum	ETX
				ID(1Byte)		Master		
				Image Processor Module ID	IP ID			
Variable	0X02	0X42	0X02	Variable	Variable	0x01	Variable	0x03

- ID Range (0x11~0x94): Upper Byte is Image Processor Module Set ID(1~9) and Lower Byte is the ID of IP Board(1~4.) In case of 4 LCD sets, IDs will be 0x11, 0x12, 0x13, and 0x14.
- Check Sum : Add values from STX to Data and execute logical operation "NOT."

4. Input Mode Change

- Convert the input mode without the scaling of LCD screen.

A. General Command

Value	STX	CMD	LENGTH	Data					Check sum	ETX
				ID(1Byte)		Master	XY	X		
				Image Processor Module ID	IP ID					
0x00	0X02	Variable	0X04	Variable	Variable	0x01	0x11	0x01	Variable	0x03

- Send To MLCD

- CMD : 0xDD(DVI 1), 0xDE(DVI 2), 0xDF(DVI 3), 0xE0(DVI 4), 0xE1(DVI Loop In)

- ID Range (0x11~0x94): Upper Byte is Image Processor Module Set ID(1~9) and Lower Byte is the ID of IP Board(1~4.) In case of 4 LCD sets, IDs will be 0x11, 0x12, 0x13, and 0x14.
- Check Sum : Add values from STX to Data and execute logical operation "NOT."

B. Broadcast Command

Value	STX	CMD	LENGTH	Data				Check sum	ETX	
				ID(1Byte)		XY	S			X
				Image Processor Module ID	IP ID					
0x00	0X02	Variable	0X04	0x00	0x00	0x11	0x00	0x01	Variable	0x03

- Send To MLCD

- Send the same command for all MLCD. No response will be made.

- Receive Data

Value	STX	CMD	LENGTH	Data			Check sum	ETX
				ID(1Byte)		Master		
				Image Processor Module ID	IP ID			
Variable	0X02	Variable	0X02	Variable	Variable	0x01	Variable	0x03

- ID Range (0x11~0x94): Upper Byte is Image Processor Module Set ID(1~9) and Lower Byte is the ID of IP Board(1~4.) In case of 4 LCD sets, IDs will be 0x11, 0x12, 0x13, and 0x14.
- Check Sum : Add values from STX to Data and execute logical operation "NOT."

5. Graphic User Mode Control

- Commands for Brightness, Sharpness, and Contrast

A. General Command

	STX	CMD	LENGTH	Data				Check sum	ETX
				ID(1Byte)		Master	Control		
				Image Processor Module ID	IP ID				
Value	0X02	Variable	0X03	Variable	Variable	0x01	Variable	0x03	

- Send To MLCD
- CMD : Brightness(0x8A), Contrast(0x8B), Sharpness(0x8C)
- Control Value : Brightness(0~100), Contrast(0~100), Sharpness(0~28)

- ID Range (0x11~0x94): Upper Byte is Image Processor Module Set ID(1~9) and Lower Byte is the ID of IP Board(1~4.) In case of 4 LCD sets, IDs will be 0x11, 0x12, 0x13, and 0x14.
- Check Sum : Add values from STX to Data and execute logical operation "NOT."

B. Broadcast Command

	STX	CMD	LENGTH	Data			Check sum	ETX
				ID(1Byte)		Control		
				Image Processor Module ID	IP ID			
Value	0X02	Variable	0X02	0x00		Variable	0x03	

- Send To MLCD
- Send the same command for all MLCD. No response will be made.

- Receive Data

	STX	CMD	LENGTH	Data			Check sum	ETX
				ID(1Byte)		Master		
				Image Processor Module ID	IP ID			
Value	0X02	Variable	0X02	Variable		0x01	Variable	0x03

- ID Range (0x11~0x94): Upper Byte is Image Processor Module Set ID(1~9) and Lower Byte is the ID of IP Board(1~4.) In case of 4 LCD sets, IDs will be 0x11, 0x12, 0x13, and 0x14.
- Check Sum : Add values from STX to Data and execute logical operation "NOT."

6. Color Temperature

- Normal mode is designed for general use and Studio mode for broadcasting purpose.

A. General Command

	STX	CMD	LENGTH	Data			Check sum	ETX
				ID(1Byte)		Master		
				Image Processor Module ID	IP ID			
Value	0X02	Variable	0X02	Variable	Variable	0x01	Variable	0x03

- Send To MLCD
- CMD : Normal(0xB3), Studio(0xB4)

- ID Range (0x11~0x94): Upper Byte is Image Processor Module Set ID(1~9) and Lower Byte is the ID of IP Board(1~4.) In case of 4 LCD sets, IDs will be 0x11, 0x12, 0x13, and 0x14.
- Check Sum : Add values from STX to Data and execute logical operation "NOT."

B. Broadcast Command

	STX	CMD	LENGTH	Data		Check sum	ETX
				ID(1Byte)			
				Image Processor Module ID	IP ID		
Value	0X02	Variable	0X01	0x00		Variable	0x03

- Send To MLCD
- Send the same command for all MLCD. No response will be made.

- Receive Data

	STX	CMD	LENGTH	Data			Check sum	ETX
				ID(1Byte)		Master		
				Image Processor Module ID	IP ID			
Value	0X02	Variable	0X02	Variable	Variable	0x01	Variable	0x03

- ID Range (0x11~0x94): Upper Byte is Image Processor Module Set ID(1~9) and Lower Byte is the ID of IP Board(1~4.) In case of 4 LCD sets, IDs will be 0x11, 0x12, 0x13, and 0x14.
- Check Sum : Add values from STX to Data and execute logical operation "NOT."

7. White Balance Control

- Command to control Gain RGB and Offset RGB for White Balance

A. General Command

	STX	CMD	LENGTH	Data				Check sum	ETX
				ID(1Byte)		Master	Control		
				Image Processor Module ID	IP ID				
Value	0X02	Variable	0X03	Variable	Variable	0x01	Variable	0x03	

- Send To MLCD
- CMD : 0xAC(Gain R), 0xAD(Gain G), 0xAE(Gain B), 0xB0(Offset R), 0xB1(Offset G), 0xB2(Offset B)
- Control Value : 0(0x00)~255(0xFF)

- The adjusted value can be applied while MLCD is operating with the input signal of the responding Mode. It cannot be applied during stand-by phase or with no input signal.
- The adjusted value can be applied to all MLCD sets by configuring the ID value as "0x00." However, it is hard to adjust white balance for all MLCD set with the same value, because each MLCD set has its own characteristics. So, it is recommended to adjust white balance one by one.
- ID Range (0x11~0x94): Upper Byte is Image Processor Module Set ID(1~9) and Lower Byte is the ID of IP Board(1~4.) In case of 4 LCD sets, IDs will be 0x11, 0x12, 0x13, and 0x14.
- Check Sum : Add values from STX to Data and execute logical operation "NOT."

- Receive Data

	STX	CMD	LENGTH	Data			Check sum	ETX
				ID(1Byte)		Master		
				Image Processor Module ID	IP ID			
Value	0X02	Variable	0X02	Variable	Variable	0x01	Variable	0x03

- ID Range (0x11~0x94): Upper Byte is Image Processor Module Set ID(1~9) and Lower Byte is the ID of IP Board(1~4.) In case of 4 LCD sets, IDs will be 0x11, 0x12, 0x13, and 0x14.
- Check Sum : Add values from STX to Data and execute logical operation "NOT."

8. Firmware Default(Flash Screen Data Load)

- Initialize the firmware as the phase before adjusting any values at the factory

	STX	CMD	LENGTH	Data			Check sum	ETX
				ID(1Byte)		Master		
				Image Processor Module ID	IP ID			
Value	0X02	0x81	0X02	Variable	Variable	0x01	Variable	0x03

- Send To MLCDD
- CMD : 0x81

- ID Range (0x11~0x94): Upper Byte is Image Processor Module Set ID(1~9) and Lower Byte is the ID of IP Board(1~4.) In case of 4 LCD sets, IDs will be 0x11, 0x12, 0x13, and 0x14.
- Check Sum : Add values from STX to Data and execute logical operation "NOT."
- Commands cannot be executed with Broadcast mode.

- Receive Data

	STX	CMD	LENGTH	Data			Check sum	ETX
				ID(1Byte)		Master		
				Image Processor Module ID	IP ID			
Value	0X02	0x81	0X02	Variable	Variable	0x01	Variable	0x03

- ID Range (0x11~0x94): Upper Byte is Image Processor Module Set ID(1~9) and Lower Byte is the ID of IP Board(1~4.) In case of 4 LCD sets, IDs will be 0x11, 0x12, 0x13, and 0x14.
- Check Sum : Add values from STX to Data and execute logical operation "NOT."

9. Gamma Control

A. General Command

	STX	CMD	LENGTH	Data				Check sum	ETX
				ID(1Byte)		Master	Control		
				Image Processor Module ID	IP ID				
Value	0X02	0x89	0x03	Variable	Variable	0x01	Variable	0x03	

- Send To MLCDD
- CMD : 0x89
- Control Value : 1(0x01)~6(0x06)

- ID Range (0x11~0x94): Upper Byte is Image Processor Module Set ID(1~9) and Lower Byte is the ID of IP Board(1~4.) In case of 4 LCD sets, IDs will be 0x11, 0x12, 0x13, and 0x14.
- Check Sum : Add values from STX to Data and execute logical operation "NOT."

B. Broadcast Command

	STX	CMD	LENGTH	Data		Check sum	ETX
				ID(1Byte)			
				Image Processor Module ID	IP ID		
Value	0X02	0x89	0X02	0x00	Variable	Variable	0x03

- Send To MLCDD
- Send the same command for all MLCDD. No response will be made.

- Receive Data

	STX	CMD	LENGTH	Data			Check sum	ETX
				ID(1Byte)		Master		
				Image Processor Module ID	IP ID			
Value	0X02	0x89	0X02	Variable		0x01	Variable	0x03

- ID Range (0x11~0x94): Upper Byte is Image Processor Module Set ID(1~9) and Lower Byte is the ID of IP Board(1~4.) In case of 4 LCD sets, IDs will be 0x11, 0x12, 0x13, and 0x14.
- Check Sum : Add values from STX to Data and execute logical operation "NOT."

10. Factory Data

- Apply the Picture Control values adjusted in the factory.

A. General Command

	STX	CMD	LENGTH	Data			Check sum	ETX
				ID(1Byte)		Master		
				Image Processor Module ID	IP ID			
Value	0X02	Variable	0X02	Variable	Variable	0x01	Variable	0x03

- Send To MLCDD
- CMD : 0x82(Save), 0x83(Load)
- The command can be executed only for Power On status.
- The present Color Temperature value is indicated based on the current mode (Normal Mode/ Studio Mode.)
- Use "Get Picture Control Data" after sending the command to check whether the Data was applied properly.

- ID Range (0x11~0x94): Upper Byte is Image Processor Module Set ID(1~9) and Lower Byte is the ID of IP Board(1~4.) In case of 4 LCD sets, IDs will be 0x11, 0x12, 0x13, and 0x14.
- Check Sum : Add values from STX to Data and execute logical operation "NOT."
- Commands cannot be executed with Broadcast mode.

- Receive Data

	STX	CMD	LENGTH	Data			Check sum	ETX
				ID(1Byte)		Master		
				Image Processor Module ID	IP ID			
Value	0X02	Variable	0X02	Variable	Variable	0x01	Variable	0x03

- ID Range (0x11~0x94): Upper Byte is Image Processor Module Set ID(1~9) and Lower Byte is the ID of IP Board(1~4.) In case of 4 LCD sets, IDs will be 0x11, 0x12, 0x13, and 0x14.
- Check Sum : Add values from STX to Data and execute logical operation "NOT."

11. Dimming Control

- The command for controlling the backlight of LCD

A. General Command

	STX	CMD	LENGTH	Data			Check sum	ETX
				ID(1Byte)		Control		
				Image Processor Module ID	IP ID			
Value	0X02	0xDC	0X02	Variable	Variable	Variable	Variable	0x03

- Send To MLCD

- CMD : 0xDC

- Control Value : 0~100(0x00~0x64)

• ID Range (0x11~0x94): Upper Byte is Image Processor Module Set ID(1~9) and Lower Byte is the ID of IP Board(1~4.) In case of 4 LCD sets, IDs will be 0x11, 0x12, 0x13, and 0x14.

• Check Sum : Add values from STX to Data and execute logical operation "NOT."

B. Broadcast Command

	STX	CMD	LENGTH	Data			Check sum	ETX
				ID(1Byte)		Control		
				Image Processor Module ID	IP ID			
Value	0X02	0xDC	0X02	0x00		Variable	Variable	0x03

- Send To MLCD

• Send the same command for all MLCD. No response will be made.

- Receive Data

	STX	CMD	LENGTH	Data			Check sum	ETX
				ID(1Byte)		Control		
				Image Processor Module ID	IP ID			
Value	0X02	0xDC	0X02	Variable	Variable	Variable	Variable	0x03

• ID Range (0x11~0x94): Upper Byte is Image Processor Module Set ID(1~9) and Lower Byte is the ID of IP Board(1~4.) In case of 4 LCD sets, IDs will be 0x11, 0x12, 0x13, and 0x14.

• Check Sum : Add values from STX to Data and execute logical operation "NOT."

12. Get Picture Control Data

- The command for checking the current Picture Control Data of LCD

	STX	CMD	LENGTH	Data			Check sum	ETX
				ID(1Byte)		Master		
				Image Processor Module ID	IP ID			
Value	0X02	0x88	0X02	Variable	Variable	0x01	Variable	0x03

- Send To MLCD

- CMD : 0x88

• ID Range (0x11~0x94): Upper Byte is Image Processor Module Set ID(1~9) and Lower Byte is the ID of IP Board(1~4.) In case of 4 LCD sets, IDs will be 0x11, 0x12, 0x13, and 0x14.

• Check Sum : Add values from STX to Data and execute logical operation "NOT."

• Commands cannot be executed with Broadcast mode.

- Receive Data

	STX	CMD	LENGTH	Data				Check sum	ETX
				ID(1Byte)		Master	Control		
				Image Processor Module ID	IP ID				
Value	0X02	0x88	0x0C	Variable	Variable	0x01	Variable	0x03

- Control(10 Bytes)

No.	Data	Length	Explanation
1	Brightness	1 byte	Range: 0(0x00)~100(0x64)
2	Contrast	1 byte	Range: 0(0x00)~100(0x64)
3	Sharpness	1 byte	Range: 0(0x00)~28(0x1C)
4	White Balance-Gain R	1 byte	Range: 0(0x00)~255(0xFF)
5	White Balance- Gain G	1byte	Range: 0(0x00)~255(0xFF)
6	White Balance Gain B	1byte	Range: 0(0x00)~255(0xFF)
7	White Balance – Offset R	1byte	Range: 0(0x00)~255(0xFF)
8	White Balance – Offset G	1byte	Range: 0(0x00)~255(0xFF)
9	White Balance – Offset B	1byte	Range: 0(0x00)~255(0xFF)
10	Gamma	1byte	Range: 0(0x00)~6(0x06)

• ID Range (0x11~0x94): Upper Byte is Image Processor Module Set ID(1~9) and Lower Byte is the ID of IP Board(1~4.) In case of 4 LCD sets, IDs will be 0x11, 0x12, 0x13, and 0x14.

• Check Sum : Add values from STX to Data and execute logical operation "NOT."

13. Test Pattern

- The command for loading the embedded patterns on LCD screen.

A. General Command

	STX	CMD	LENGTH	Data			Check sum	ETX
				ID(1Byte)		Master		
				Image Processor Module ID	IP ID			
Value	0X02	Variable	0X02	Variable	Variable	0x01	Variable	0x03

- Send To MLCD

- CMD : 0x57(Red), 0x58(Green), 0x59(Blue), 0x5A(White), 0x5C(Test), 0x5B(Screen)

• ID Range (0x11~0x94): Upper Byte is Image Processor Module Set ID(1~9) and Lower Byte is the ID of IP Board(1~4.) In case of 4 LCD sets, IDs will be 0x11, 0x12, 0x13, and 0x14.

• Check Sum : Add values from STX to Data and execute logical operation "NOT."

B. Broadcast Command

	STX	CMD	LENGTH	Data			Check sum	ETX
				ID(1Byte)		Master		
				Image Processor Module ID	IP ID			
Value	0X02	Variable	0X01	0x00		Variable	0x03	

- Send To MLCD

• Send the same command for all MLCD. No response will be made.

- Receive Data

Value	STX	CMD	LENGTH	Data			Check sum	ETX
				ID(1Byte)		Master		
				Image Processor Module ID	IP ID			
	0X02	Variable	0X02	Variable	Variable	0x01	Variable	0x03

- ID Range (0x11~0x94): Upper Byte is Image Processor Module Set ID(1~9) and Lower Byte is the ID of IP Board(1~4.) In case of 4 LCD sets, IDs will be 0x11, 0x12, 0x13, and 0x14.
- Check Sum : Add values from STX to Data and execute logical operation "NOT."

14. DVI Over Scan ON / OFF

- The optional adjustment command for Over Scan while DTV input signal is detected at DVI port.

A. General Command

Value	STX	CMD	LENGTH	Data			Check sum	ETX
				ID(1Byte)		Master		
				Image Processor Module ID	IP ID			
	0X02	Variable	0X02	Variable	Variable	0x01	Variable	0x03

- Send To MLCDD
- CMD : 0xE4(ON), 0xE5(OFF)

- ID Range (0x11~0x94): Upper Byte is Image Processor Module Set ID(1~9) and Lower Byte is the ID of IP Board(1~4.) In case of 4 LCD sets, IDs will be 0x11, 0x12, 0x13, and 0x14.
- Check Sum : Add values from STX to Data and execute logical operation "NOT."

B. Broadcast Command

Value	STX	CMD	LENGTH	Data		Check sum	ETX
				ID(1Byte)			
				Image Processor Module ID	IP ID		
	0X02	Variable	0X01	0x00		Variable	0x03

- Send the same command for all MLCDD. No response will be made.

- Receive Data

Value	STX	CMD	LENGTH	Data			Check sum	ETX
				ID(1Byte)		Master		
				Image Processor Module ID	IP ID			
	0X02	Variable	0X02	Variable	Variable	0x01	Variable	0x03

- ID Range (0x11~0x94): Upper Byte is Image Processor Module Set ID(1~9) and Lower Byte is the ID of IP Board(1~4.) In case of 4 LCD sets, IDs will be 0x11, 0x12, 0x13, and 0x14.
- Check Sum : Add values from STX to Data and execute logical operation "NOT."

15. Auto Power Mode

- The system can be turned on automatically when AC power is connected

A. General Command

Value	STX	CMD	LENGTH	Data		Check sum	ETX
				ID(1Byte)			
				Image Processor Module ID	Power ID		
	0X02	Variable	0X01	Variable	0x09	Variable	0x03

- Send To MLCDD
- CMD : 0x62(select), 0x63(deselect)

- ID range (0x19~0x99) : Upper Byte is for Image Processor Module Set ID(1~9) and Lower Byte is fixed as 9. In case of 4 LCD sets, Auto Power Mode can be selected or deselected for all 4 sets by setting the ID for 0x19 and sending command.
- IDs can be set according to the total numbers of the sets. If LCD sets are 4, ID can be set as 0x19, 8sets for 0x29, 12sets for 0x39.... and 36sets for 0x99.
- Check Sum : Add values from STX to Data and execute logical operation "NOT."

B. Broadcast Command

Value	STX	CMD	LENGTH	Data		Check sum	ETX
				ID(1Byte)			
				Image Processor Module ID	Power ID		
	0X02	Variable	0X01	0x00		Variable	0x03

- Send To MLCDD
- Send the same command for all MLCDD. No response will be made.

- Receive Data

Value	STX	CMD	LENGTH	Data		Check sum	ETX
				ID(1Byte)			
				Image Processor Module ID	Power ID		
	0X02	Variable	0X01	Variable	0x09	Variable	0x03

- ID range (0x19~0x99) : Upper Byte is for Image Processor Module Set ID(1~9) and Lower Byte is fixed as 9. In case of 4 LCD sets, Auto Power Mode can be selected or deselected for all 4 sets by setting the ID for 0x19 and sending command.
- IDs can be set according to the total numbers of the sets. If LCD sets are 4, ID can be set as 0x19, 8sets for 0x29, 12sets for 0x39.... and 36sets for 0x99.
- Check Sum : Add values from STX to Data and execute logical operation "NOT."

16. Global Offset

- The images on the seam area between the screens can be displayed on the screen or omitted from the screen. It can be selected to improve the continuity of the images.

A. General Command

Value	STX	CMD	LENGTH	Data			Check sum	ETX
				ID(1Byte)		Master		
				Image Processor Module ID	IP ID			
	0X02	Variable	0X02	Variable	Variable	0x01	Variable	0x03

- Send To MLC D
- CMD : 0x74(select), 0x73(deselect)

- ID Range (0x11~0x94): Upper Byte is Image Processor Module Set ID(1~9) and Lower Byte is the ID of IP Board(1~4.) In case of 4 LCD sets, IDs will be 0x11, 0x12, 0x13, and 0x14.
- Check Sum : Add values from STX to Data and execute logical operation "NOT."

B. Broadcast Command

	STX	CMD	LENGTH	Data		Check sum	ETX
				ID(1Byte)			
				Image Processor Module ID	Power ID		
Value	0X02	Variable	0X01	0x00		Variable	0x03

- Send To MLC D
- Send the same command for all MLC D. No response will be made.

- Receive Data

	STX	CMD	LENGTH	Data			Check sum	ETX
				ID(1Byte)		Master		
				Image Processor Module ID	IP ID			
Value	0X02	Variable	0X02	Variable	Variable	0x01	Variable	0x03

- ID Range (0x11~0x94): Upper Byte is Image Processor Module Set ID(1~9) and Lower Byte is the ID of IP Board(1~4.) In case of 4 LCD sets, IDs will be 0x11, 0x12, 0x13, and 0x14.
- Check Sum : Add values from STX to Data and execute logical operation "NOT."

17. Factory Dimming Data

	STX	CMD	LENGTH	Data		Check sum	ETX
				ID(1Byte)			
				Image Processor Module ID	IP ID		
Value	0X02	Variable	0X01	Variable	Variable	Variable	0x03

- Send To MLC D
- CMD : 0x6C(Save), 0x6B(Load)

- ID Range (0x11~0x94): Upper Byte is Image Processor Module Set ID(1~9) and Lower Byte is the ID of IP Board(1~4.) In case of 4 LCD sets, IDs will be 0x11, 0x12, 0x13, and 0x14.
- Check Sum : Add values from STX to Data and execute logical operation "NOT."
- Commands cannot be executed with Broadcast mode.

- Receive Data

	STX	CMD	LENGTH	Data		Control	Check sum	ETX
				ID(1Byte)				
				Image Processor Module ID	IP ID			
Value	0X02	Variable	0x02	Variable	Variable	Variable	0x03

- Control Value : 0(0x00)~100(0x64)

- ID Range (0x11~0x94): Upper Byte is Image Processor Module Set ID(1~9) and Lower Byte is the ID of IP Board(1~4.) In case of 4 LCD sets, IDs will be 0x11, 0x12, 0x13, and 0x14.
- Check Sum : Add values from STX to Data and execute logical operation "NOT."

18. Multi Scale

- The command for enlarging the screen of MLC D

A. General Command

	STX	CMD	LENGTH	Data					Check sum	ETX
				ID		Master	XY	P		
				Image Processor Module ID	IP ID					
Value	0X02	Variable	0X04	Variable	Variable	0x01	Variable	Variable	Variable	0x03

- Send To MLC D
- CMD : 0xDD(DVI 1), 0xDE(DVI 2), 0xDF(DVI 3), 0xE0(DVI 4), 0xE1(DVI 5)
- XY : the number of horizontal axis (X), the number of vertical axis (Y)
Upper 4bits(X- Max :15), lower 4bits(Y - Max:15)
- P : the enlarged position

- ID Range (0x11~0x94): Upper Byte is Image Processor Module Set ID(1~9) and Lower Byte is the ID of IP Board(1~4.) In case of 4 LCD sets, IDs will be 0x11, 0x12, 0x13, and 0x14.
- Check Sum : Add values from STX to Data and execute logical operation "NOT."

- Receive Data

	STX	CMD	LENGTH	Data			Check sum	ETX
				ID(1Byte)		Master		
				Image Processor Module ID	IP ID			
Value	0X02	Variable	0X02	Variable	Variable	0x01	Variable	0x03

- ID Range (0x11~0x94): Upper Byte is Image Processor Module Set ID(1~9) and Lower Byte is the ID of IP Board(1~4.) In case of 4 LCD sets, IDs will be 0x11, 0x12, 0x13, and 0x14.
- Check Sum : Add values from STX to Data and execute logical operation "NOT."

19. Get Current Status

- The command for getting the current information on IP, IR, IC, and Power.

A. Image Receiver Board Status

	STX	CMD	LENGTH	Data		Check sum	ETX
				ID(1Byte)			
				Image Processor Module ID	IR ID		
Value	0X02	0x87	0X01	Variable	Variable	Variable	0x03

- Send To MLC D
- CMD : 0x87

- ID Range (0x15~0x98): Upper Byte is Image Processor Module Set ID(1~9) and Lower Byte is the ID of IR Board(5~8) In case of 4 LCD sets, IDs will be 0x15, 0x16, 0x17, and 0x18.
- Check Sum : Add values from STX to Data and execute logical operation "NOT."
- Commands cannot be executed with Broadcast mode.

- Receive Data

	STX	CMD	LENGTH	Data			Check sum	ETX
				ID(1Byte)		Control		
				Image Processor Module ID	IR ID			
Value	0X02	0x87	0X13	Variable	Variable	Variable	0x03

- Control (18 Bytes)

No	Data	Length	Explanation
1	Dimming Status	1 Byte	0(0x00)~100(0x64)
2	Temperature	1 Byte	0(0x00):0°C ~127(0x7F): 127°C / 128(0x80): -1°C~254(0xFE):-127°C 0xFF: Temp Sensor Error
3	Elapsed Time	6 Bytes	54321 : 0x00 0x05 0x04 0x03 0x02 0x01 10 : 0x00 0x00 0x00 0x00 0x01 0x00
4	F/W Version	10 Bytes	Board Name : 3 bytes Year : 2 bytes Month : 2bytes Day : 2bytes Version Mode : (Release Or Test) 1 byte Ex) Image Receiver Board, December 29 th , 2012 Release ->/R(ASCII) 0x49 0x2F 0x52 0x01 0x02 0x01 0x02 0x02 0x09 R(ASCII) -> 0x52

- ID Range (0x15~0x98): Upper Byte is Image Processor Module Set ID(1~9) and Lower Byte is the ID of IR Board(5~8) In case of 4 LCD sets, IDs will be 0x15, 0x16, 0x17, and 0x18.
- Check Sum : Add values from STX to Data and execute logical operation "NOT."

B. Image Processor Board Status

	STX	CMD	LENGTH	Data			Check sum	ETX
				ID(1Byte)		Master		
				Image Processor Module ID	IP ID			
Value	0X02	0x87	0X02	Variable	Variable	0x01	Variable	0x03

- Send To MLCDD

- CMD : 0x87

- ID Range (0x11~0x94): Upper Byte is Image Processor Module Set ID(1~9) and Lower Byte is the ID of IP Board(1~4.) In case of 4 LCD sets, IDs will be 0x11, 0x12, 0x13, and 0x14.
- Check Sum : Add values from STX to Data and execute logical operation "NOT."
- Commands cannot be executed with Broadcast mode.

- Receive Data

	STX	CMD	LENGTH	Data				Check sum	ETX
				ID(1Byte)		Master	Control		
				Image Processor Module ID	IP ID				
Value	0X02	0x87	0x10	Variable	Variable	0x01	Variable	0x03

- Control(14 Bytes)

No	Data	Length	Explanation
1	Input Channel	1 Byte	0x01: DVI 1, 0x02: DVI 2, 0x03: DVI 3, 0x04: DVI 4, 0x05: DVI Loop In
2	Resolution	1 Byte	The Value of Display Resolution at the time of detection
3	Global Offset	1 Byte	0: Global Offset Off, 1: Global Offset On
4	Color Temperature	1 Byte	0: Normal Mode, 1: Studio Mode
5	F/W Version	10 Bytes	Board Name:3bytes, Year : 2bytes, Month : 2bytes, Day : 2bytes Version Mode(Release or Test) : 1byte Ex)Image Processor Board, December 29 th , 2012 Release I/P(ASCII) 0x49 0x2F 0x50 0x01 0x02 0x01 0x02 0x02 0x09 R(ASCII) -> 0x52

- ID Range (0x11~0x94): Upper Byte is Image Processor Module Set ID(1~9) and Lower Byte is the ID of IP Board(1~4.) In case of 4 LCD sets, IDs will be 0x11, 0x12, 0x13, and 0x14.
- Check Sum : Add values from STX to Data and execute logical operation "NOT."

C. Image Control Board Status

	STX	CMD	LENGTH	Data		Check sum	ETX
				ID(1Byte)			
				Image Processor Module ID	IC ID		
Value	0X02	Variable	0X01	Variable	0x00	Variable	0x03

- Send To MLCDD

- CMD : 0x87

- ID Range (0x10~0x90): Upper Byte is Image Processor Module Set ID(1~9) and Lower Byte is the ID of IC Board(fixed as 0.) In case of 36 LCD sets or 9 Image Processor Module Sets, IDs will be 0x10, 0x20, 0x30, 0x40, 0x50, 0x60, 0x70, 0x80, and 0x90.
- Check Sum : Add values from STX to Data and execute logical operation "NOT."
- Command cannot be executed with Broadcast mode.

- Receive Data

	STX	CMD	LENGTH	Data			Check sum	ETX
				ID(1Byte)		Control		
				Image Processor Module ID	IC ID			
Value	0X02	0x87	0X1C	Variable	0x00	Variable	0x03

- Control (27 Bytes)

No	Data	Length	Explanation
1	Loop Out Channel	1 byte	Loop Out Channels from Image Processor Module : 0x00(DVI Loop In),0x01(DVI1), 0x02(DVI2),0x03(DVI3),0x04(DVI4)
2	Fan Status	1 byte	0x00 : Error , 0x01: Good
3	Auto Power Mode	1 byte	0x00: Auto Power Off, 0x01: Auto Power On
4	IP Board 1 Input Channel	1 byte	0x00(DVI Loop In),0x01(DVI1), 0x02(DVI2),0x03(DVI3),0x04(DVI4)
5	IP Board 2 Input Channel	1 byte	0x00(DVI Loop In),0x01(DVI1), 0x02(DVI2),0x03(DVI3),0x04(DVI4)
6	IP Board 3 Input Channel	1 byte	0x00(DVI Loop In),0x01(DVI1), 0x02(DVI2),0x03(DVI3),0x04(DVI4)
7	IP Board 4 Input Channel	1 byte	0x00(DVI Loop In),0x01(DVI1), 0x02(DVI2),0x03(DVI3),0x04(DVI4)
8	F/W Version	10 bytes	Board Name:3bytes, Year : 2bytes, Month : 2bytes, Day : 2bytes Version Mode(Release or Test) : 1byte Ex)Image Control Board, December 29 th , 2012 Release I/C(ASCII) 0x49 0x2F 0x43 0x01 0x02 0x01 0x02 0x02 0x09 R(ASCII) 0x52

No	Data	Length	Explanation
9	F/W Version	10 bytes	Board Name:3bytes, Year : 2bytes, Month : 2bytes, Day : 2bytes Version Mode(Release or Test) : 1byte Ex)Matrix Switcher Board, December 29 th , 2012 Release MTX(ASCII) 0x4D 0x54 0x58 0x01 0x02 0x01 0x02 0x02 0x09 R(ASCII) 0x52

- ID Range (0x10~0x90): Upper Byte is Image Processor Module Set ID(1~9) and Lower Byte is the ID of IC Board(fixed as 0.) In case of 36 LCD sets or 9 Image Processor Module Sets, IDs will be 0x10, 0x20, 0x30, 0x40, 0x50, 0x60, 0x70, 0x80, and 0x90.
- Check Sum : Add values from STX to Data and execute logical operation "NOT."

D. Power Board Status

	STX	CMD	LENGTH	Data		Check sum	ETX
				ID(1Byte)			
				Image Processor Module ID	Power ID		
Value	0X02	Variable	0X01	Variable	0x09	Variable	0x03

- Send To MLC D
- CMD : 0x87

- ID Range (0x19~0x99): Upper Byte is Image Processor Module Set ID(1~9) and Lower Byte is the ID of Power Board(fixed as 9.) In case of 4 LCD sets, current status information of 4 sets can be obtained by sending command with the ID of 0x19.
- IDs will be 0x19 for 4 sets, 0x29 for 8 sets, 0x39 for 12 sets,....and 0x99 for 36sets..
- Check Sum : Add values from STX to Data and execute logical operation "NOT."

- Receive Data

	STX	CMD	LENGTH	Data			Check sum	ETX
				ID(1Byte)		Control		
				Image Processor Module ID	Power ID			
Value	0X02	0x87	0X13	Variable	0x09	Variable	0x03

- Control(18 Bytes)

No	Data	Length	Explanation
1	Power Board 1 Status	1 byte	0:PowerOff(Stand-by), 1:PowerOn(Working)
2	Power Board 2 Status	1 byte	0:PowerOff(Stand-by), 1:PowerOn(Working)
3	Power Board 3 Status	1 byte	0:PowerOff(Stand-by), 1:PowerOn(Working)
4	Power Board 4 Status	1 byte	0:PowerOff(Stand-by), 1:PowerOn(Working)
5	Redundant Power Status	1 byte	It is all time Power Off. It will be turned on, if there is any abnormal situation for Power 1, 2, 3, and 4 0:PowerOff(Stand-by), 1:PowerOn(Working)
6	Auto Power Mode	1 byte	0: Auto Power Off, 1: Auto Power On
7	Fan 1 Status	1 byte	0x31 : Good, 0x30 : Error
8	Fan 2 Status	1 byte	0x31 : Good, 0x30 : Error
9	F/W Version	10 bytes	Board Name:3bytes, Year : 2bytes, Month : 2bytes, Day : 2bytes Version Mode(Release or Test) : 1byte Ex)Power Board, December 29 th , 2012 Release PWR(ASCII) 0x50 0x57 0x52 0x01 0x02 0x01 0x02 0x02 0x09 R(ASCII) 0x52

- ID Range (0x19~0x99): Upper Byte is Image Processor Module Set ID(1~9) and Lower Byte is the ID of Power Board(fixed as 9.) In case of 4 LCD sets, current status information of 4 sets can be obtained by sending command with the ID of 0x19.
- IDs will be 0x19 for 4 sets, 0x29 for 8 sets, 0x39 for 12 sets,....and 0x99 for 36sets..
- Check Sum : Add values from STX to Data and execute logical operation "NOT."

20. DVI Loop Out Channel Change

- If there are 2 or more than Image Processor Module Sets, user can select a channel for Loop out (Daisy-Chain Out.)
- CMD : 0x50

A. General Command

	STX	CMD	LENGTH	Data		Loop OutChannel	Check sum	ETX
				ID(1Byte)				
				Image Processor Module ID	IC ID			
Value	0X02	0x50	0X02	Variable	0x00	Variable	Variable	0x03

- Send To MLC D
- Loop Out Channel Value : DVI 1(0x01), DVI 2(0x02), DVI 3(0x03), DVI 4(0x04),
- DVI Loop In(0x00)

- ID Range (0x10~0x90): Upper Byte is Image Processor Module Set ID(1~9) and Lower Byte is the ID of IC Board(fixed as 0.) In case of 36 LCD sets or 9 Image Processor Module Sets, IDs will be 0x10, 0x20, 0x30, 0x40, 0x50, 0x60, 0x70, 0x80, and 0x90.
- Check Sum : Add values from STX to Data and execute logical operation "NOT."

B. Broadcast Command

	STX	CMD	LENGTH	Data		Loop OutChannel	Check sum	ETX
				ID(1Byte)				
				Image Processor Module ID	IC ID			
Value	0X02	0x50	0X02	0x00		Variable	Variable	0x03

- Send To MLC D
- Send the same command for all MLC D. No response will be made.
- Receive Data

	STX	CMD	LENGTH	Data		Loop OutChannel	Check sum	ETX
				ID(1Byte)				
				Image Processor Module ID	IC ID			
Value	0X02	0x50	0X02	Variable	0x00	Variable	Variable	0x03

- Loop Out Channel Value : DVI 1(0x01), DVI 2(0x02), DVI 3(0x03), DVI 4(0x04),
- DVI Loop In(0x00)

- ID Range (0x10~0x90): Upper Byte is Image Processor Module Set ID(1~9) and Lower Byte is the ID of IC Board(fixed as 0.) In case of 36 LCD sets or 9 Image Processor Module Sets, IDs will be 0x10, 0x20, 0x30, 0x40, 0x50, 0x60, 0x70, 0x80, and 0x90.
- Check Sum : Add values from STX to Data and execute logical operation "NOT."

21. DE-Emphasis Control

- The command for compensating output signal loss according to the cable length
- CMD : 0x51

A. General Command

	STX	CMD	LENGTH	Data				Check sum	ETX
				ID(1Byte)		Equalizer Control	DE-Emphasis Control		
				Image Processor Module ID	IP ID				
Value	0X02	0x51	0x03	Variable	Variable	0x00	Variable	0x03	

- Send To MLC D
- DE-Emphasis Control Value : 0(0x00),1(0x01),2(0x02),3(0x03)

Inputs	Result	
DE-Emphasis	VO De-Emphasis Level in mVp-p(VODE w/VOD_CRL=24kΩ)	VO De-Emphasis in Db
0	1000(Default)	0(Default)
1	710	-3
2	500	-6
3	355	-9

- ID Range (0x11~0x94): Upper Byte is Image Processor Module Set ID(1~9) and Lower Byte is the ID of IP Board(1~4.) In case of 4 LCD sets, IDs will be 0x11, 0x12, 0x13, and 0x14.
- Check Sum : Add values from STX to Data and execute logical operation "NOT."

B. Broadcast Command

	STX	CMD	LENGTH	Data				Check sum	ETX
				ID(1Byte)		Equalizer Control	DE-Emphasis Control		
				Image Processor Module ID	IP ID				
Value	0X02	0x51	0x03	0x00		0x00	Variable	0x03	

- Send the same command for all MLC D. No response will be made.

- Receive Data

	STX	CMD	LENGTH	Data				Check sum	ETX
				ID(1Byte)		Equalizer Control	DE-Emphasis Control		
				Image Processor Module ID	IP ID				
Value	0X02	0x51	0x03	Variable	Variable	0x00	Variable	0x03	

- DE-Emphasis Control Value : 0(0x00),1(0x01),2(0x02),3(0x03)

Inputs	Result	
DE-Emphasis	VO De-Emphasis Level in mVp-p(VODE w/VOD_CRL=24kΩ)	VO De-Emphasis in Db
0	1000(Default)	0(Default)
1	710	-3
2	500	-6
3	355	-9

- ID Range (0x11~0x94): Upper Byte is Image Processor Module Set ID(1~9) and Lower Byte is the ID of IP Board(1~4.) In case of 4 LCD sets, IDs will be 0x11, 0x12, 0x13, and 0x14.
- Check Sum : Add values from STX to Data and execute logical operation "NOT."

22. DE-Emphasis Get Current Status

- The command for collecting the current configuration information of DE-Emphasis for compensating the output signal loss based on the cable length.
- CMD : 0x52

A. General Command

	STX	CMD	LENGTH	Data		Check sum	ETX
				ID(1Byte)			
				Image Processor Module ID	IP ID		
Value	0X02	0x52	0X01	Variable	0x00	Variable	0x03

- Send To MLC D

- ID Range (0x11~0x94): Upper Byte is Image Processor Module Set ID(1~9) and Lower Byte is the ID of IP Board(1~4.) In case of 4 LCD sets, IDs will be 0x11, 0x12, 0x13, and 0x14.
- Check Sum : Add values from STX to Data and execute logical operation "NOT."
- Command cannot be executed with Broadcast mode.

- Receive Data

	STX	CMD	LENGTH	Data				Check sum	ETX
				ID(1Byte)		Equalizer Current Status	DE-Emphasis Current Status		
				Image Processor Module ID	IP ID				
Value	0X02	0x52	0x03	Variable	Variable	0x00	Variable	0x03	

- DE-Emphasis Current Status Value : 0(0x00),1(0x01),2(0x02),3(0x03)

- ID Range (0x11~0x94): Upper Byte is Image Processor Module Set ID(1~9) and Lower Byte is the ID of IP Board(1~4.) In case of 4 LCD sets, IDs will be 0x11, 0x12, 0x13, and 0x14.
- Check Sum : Add values from STX to Data and execute logical operation "NOT."

23. Equalizer Control

- The command for compensating the input signal loss from the cable length.
- CMD : 0x51

A. General Command

Value	STX	CMD	LENGTH	Data				Check sum	ETX
				ID(1Byte)		Equalizer Control	DE-Emphasis Control		
				Image Processor Module ID	IR ID				
	0X02	0x51	0x03	Variable	Variable	Variable	0x00	Variable	0x03

- Send To MLC D

- Equalizer Control Value : 0(0x00),1(0x01),2(0x02),3(0x03),4(0x04),5(0x05),6(0x06),7(0x07)

• Recommendation for STP Cable

Format (Data Rate)	0~10m Cable	Over 10m Cable
1080P (1.65Gbps)	0~1	2~6

• Recommendation for UTP Cable

Format (Data Rate)	0~10m Cable	Over 10m Cable
1080P (1.65Gbps)	0~1	2~5

- ID Range (0x15~0x98): Upper Byte is Image Processor Module Set ID(1~9) and Lower Byte is the ID of IR Board(5~8.) In case of 4 LCD sets, IDs will be 0x15, 0x16, 0x17, and 0x18.
- Check Sum : Add values from STX to Data and execute logical operation "NOT."

B. Broadcast Command

Value	STX	CMD	LENGTH	Data				Check sum	ETX
				ID(1Byte)		Equalizer Control	DE-Emphasis Control		
				Image Processor Module ID	IR ID				
	0X02	0x51	0x03	0x00		Variable	0x00	Variable	0x03

- Send the same command for all MLC D. No response will be made.

- Receive Data

Value	STX	CMD	LENGTH	Data				Check sum	ETX
				ID(1Byte)		Equalizer Control	DE-Emphasis Control		
				Image Processor Module ID	IR ID				
	0X02	0x51	0x03	Variable	Variable	Variable	0x00	Variable	0x03

- Equalizer Control Value : 0(0x00),1(0x01),2(0x02),3(0x03),4(0x04),5(0x05),6(0x06),7(0x07)

- ID Range (0x15~0x98): Upper Byte is Image Processor Module Set ID(1~9) and Lower Byte is the ID of IR Board(5~8.) In case of 4 LCD sets, IDs will be 0x15, 0x16, 0x17, and 0x18.
- Check Sum : Add values from STX to Data and execute logical operation "NOT."

24. Equalizer Get Current Status

- The command for collecting information of the current Equalizer configuration. Equalizer is adjusted to compensate the input signal loss according to the cable length.
- CMD : 0x52

A. General Command

Value	STX	CMD	LENGTH	Data		Check sum	ETX
				ID(1Byte)			
				Image Processor Module ID	IR ID		
	0X02	0x52	0X01	Variable	Variable	Variable	0x03

- Send To MLC D

- ID Range (0x15~0x98): Upper Byte is Image Processor Module Set ID(1~9) and Lower Byte is the ID of IR Board(5~8.) In case of 4 LCD sets, IDs will be 0x15, 0x16, 0x17, and 0x18.
- Check Sum : Add values from STX to Data and execute logical operation "NOT."
- Command cannot be executed with Broadcast mode.

- Receive Data

Value	STX	CMD	LENGTH	Data				Check sum	ETX
				ID(1Byte)		Equalizer Current Status	DE-Emphasis Current Status		
				Image Processor Module ID	IR ID				
	0X02	0x52	0x03	Variable	Variable	Variable	0x00	Variable	0x03

- Equalizer Current Status Value: 0(0x00),1(0x01),2(0x02),3(0x03),4(0x04),5(0x05),6(0x06),7(0x07)

- ID Range (0x15~0x98): Upper Byte is Image Processor Module Set ID(1~9) and Lower Byte is the ID of IR Board(5~8.) In case of 4 LCD sets, IDs will be 0x15, 0x16, 0x17, and 0x18.
- Check Sum : Add values from STX to Data and execute logical operation "NOT."

25. Picture Control Data Save in IR

- The command for saving Picture Control Data in IR ; Brightness, Contrast, Sharpness, White Balance Data and Gamma Data

- Send To MLC D

value	STX	CMD	LENGTH	Data			Check sum	ETX
				ID(1Byte)		Picture Control		
				Image Processor Module ID	IP ID			
	0X02	0x84	0x0C	Variable	Variable	Variable	0x03

- CMD : 0x84

- ID Range (0x11~0x94): Upper Byte is Image Processor Module Set ID(1~9) and Lower Byte is the ID of IP Board(1~4.) In case of 4 LCD sets, IDs will be 0x11, 0x12, 0x13, and 0x14.
- Check Sum : Add values from STX to Data and execute logical operation "NOT."
- Command cannot be executed with Broadcast mode.

- Control

No.	Data	Length	Explanation
1	Color Temperature Mode	1 byte	Normal : 0x00, Studio : 0x01
2	Brightness	1 byte	Range: 0(0x00)~100(0x64)
3	Contrast	1 byte	Range: 0(0x00)~100(0x64)
4	Sharpness	1 byte	Range:0(0x00)~28(0x1C)

No.	Data	Length	Explanation
5	White Balance-Gain R	1 byte	Range: 0(0x00)~255(0xFF)
6	White Balance- Gain G	1byte	Range: 0(0x00)~255(0xFF)
7	White Balance – Gain B	1byte	Range: 0(0x00)~255(0xFF)
8	White Balance – Offset R	1byte	Range: 0(0x00)~255(0xFF)
9	White Balance – Offset G	1byte	Range: 0(0x00)~255(0xFF)
10	White Balance – Offset B	1byte	Range: 0(0x00)~255(0xFF)
11	Gamma	1byte	Range: 0(0x00)~6(0x06)

- Receive Data

value	STX	CMD	LENGTH	Data			Check sum	ETX
				ID(1Byte)		Picture Control		
				Image Processor Module ID	IP ID			
	0X02	0x84	0x0C	Variable	Variable	Variable	0x03

- Control(11 Bytes)

No.	Data	Length	Explanation
1	Color Temperature Mode	1 byte	Normal : 0x00, Studio : 0x01
2	Brightness	1 byte	Range: 0(0x00)~100(0x64)
3	Contrast	1 byte	Range:0(0x00)~100(0x64)
4	Sharpness	1 byte	Range:0(0x00)~28(0x1C)
5	White Balance-Gain R	1 byte	Range:0(0x00)~255(0xFF)
6	White Balance- Gain G	1byte	Range:0(0x00)~255(0xFF)
7	White Balance – Gain B	1byte	Range:0(0x00)~255(0xFF)
8	White Balance – Offset R	1byte	Range:0(0x00)~255(0xFF)
9	White Balance – Offset G	1byte	Range:0(0x00)~255(0xFF)
10	White Balance – Offset B	1byte	Range:0(0x00)~255(0xFF)
11	Gamma	1byte	Range:0(0x00)~6(0x06)

- ID Range (0x11~0x94): Upper Byte is Image Processor Module Set ID(1~9) and Lower Byte is the ID of IP Board(1~4.) In case of 4 LCD sets, IDs will be 0x11, 0x12, 0x13, and 0x14.
- Check Sum : Add values from STX to Data and execute logical operation "NOT."

26. Picture Control Data Load to IP

- The command for loading Picture Control Data; Brightness, Contrast, Sharpness, White Balance Data and Gamma Data
- Send To MLCD

value	STX	CMD	LENGTH	Data			Check sum	ETX
				ID(1Byte)		Color Temperature Mode		
				Image Processor Module ID	IP ID			
	0X02	0x85	0x02	Variable	Variable	Variable	Variable	0x03

- CMD : 0x85
- Color Temperature Mode : Normal(0x00), Studio(0x01)
- ID Range (0x11~0x94): Upper Byte is Image Processor Module Set ID(1~9) and Lower Byte is the ID of IP Board(1~4.) In case of 4 LCD sets, IDs will be 0x11, 0x12, 0x13, and 0x14.
- Check Sum : Add values from STX to Data and execute logical operation "NOT."

- Receive Data

value	STX	CMD	LENGTH	Data			Check sum	ETX
				ID(1Byte)		Picture Control		
				Image Processor Module ID	IP ID			
	0X02	0x85	0x0C	Variable	Variable	Variable	0x03

- Control(11 Bytes)

No.	Data	Length	Explanation
1	Color Temperature Mode	1 byte	Normal : 0x00, Studio : 0x01
2	Brightness	1 byte	Range: 0(0x00)~100(0x64)
3	Contrast	1 byte	Range:0(0x00)~100(0x64)
4	Sharpness	1 byte	Range:0(0x00)~28(0x1C)
5	White Balance-Gain R	1 byte	Range:0(0x00)~255(0xFF)
6	White Balance- Gain G	1byte	Range:0(0x00)~255(0xFF)
7	White Balance – Gain B	1byte	Range:0(0x00)~255(0xFF)
8	White Balance – Offset R	1byte	Range:0(0x00)~255(0xFF)
9	White Balance – Offset G	1byte	Range:0(0x00)~255(0xFF)
10	White Balance – Offset B	1byte	Range:0(0x00)~255(0xFF)
11	Gamma	1byte	Range:0(0x00)~6(0x06)

- ID Range (0x11~0x94): Upper Byte is Image Processor Module Set ID(1~9) and Lower Byte is the ID of IP Board(1~4.) In case of 4 LCD sets, IDs will be 0x11, 0x12, 0x13, and 0x14.
- Check Sum : Add values from STX to Data and execute logical operation "NOT."

※ Attachment : ASCII to HEX Conversion Table

ASCII	HEX	ASCII	HEX	ASCII	HEX	ASCII	HEX	ASCII	HEX	ASCII	HEX	ASCII	HEX
STX	02	*	2A	9	39	H	48	W	57	f	66	u	75
ETX	03	+	2B	:	3A	I	49	X	58	g	67	v	76
Esc	1B	,	2C	;	3B	J	4A	Y	59	h	68	w	77
CR	0D	-	2D	<	3C	K	4B	Z	5A	i	69	x	78
LF	0A	.	2E	=	3D	L	4C	[5B	j	6A	y	79
Space	20	/	2F	>	3E	M	4D	\	5C	k	6B	z	7A
!	21	0	30	?	3F	N	4E]	5D	l	6C	{	7B
"	22	1	31	@	40	O	4F	^	5E	m	6D		7C
#	23	2	32	A	41	P	50	-	5F	n	6E	}	7D
\$	24	3	33	B	42	Q	51	`	60	o	6F	~	7E
%	25	4	34	C	43	R	52	a	61	p	70	DEL	7F
&	26	5	35	D	44	S	53	b	62	q	71		
'	27	6	36	E	45	T	54	c	63	r	72		
(28	7	37	F	46	U	55	d	64	s	73		
)	29	8	38	G	47	V	56	e	65	t	74		

7. Before calling for service

- Before calling for any repair, check the following and then refer to a near A/S center.

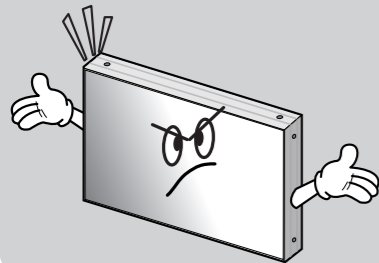

► "Tick" sound from the main body.

- If there is no problem with the screen or sound, the "tick" sound is likely to result from the cabinet lightly shrinking with the change of room temperature. The sound does not affect product's performance.

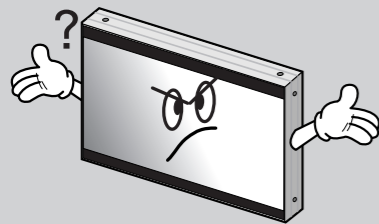

► No image at upper and lower part of the screen.

- As for a screen which is over 16:9 in width (such as cinema-sized one), no image may be displayed at upper and bottom part of the screen.

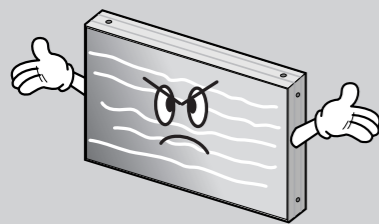

► Speckles or white lines on the screen.

- Check whether the problem is caused by vehicle, streetcar, high-voltage cable or neon sign, which emitting interference wave or electromagnetic induction. Avoid any interfering object.

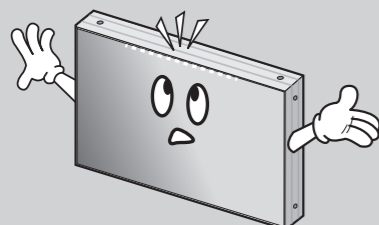

► Light leakage can be found at the edge areas around the screen.

- If the light leakage is not detected at 1m from the screen, the panel is considered as no defect. (SAMSUNG LCD applies the same inspection standard)
- To minimize the light leakage, the MLCD sets should be installed with high accuracy in horizontal and vertical position.

8. DVI Resolution

Resolution	V-Freq (Hz)	H-Freq (KHz)	Pixel Clock (MHz)	Horizontal (Pixels)				Vertical (Lines)				Pol. (H/V)	Standard Type
				Total	Addr. Width	Sync. Width	Back Porch	Total	Addr. Width	Sync. Width	Back Porch		
640*480*60	60	31.469	25.175	800	640	96	40	525	480	2	25	-/-	DMT
800*600*50	50	30.998	30.750	992	800	72	96	621	600	4	14	+/+	CVT
800*600*60	60	37.879	40.000	1056	800	128	88	628	600	4	23	+/+	DMT
1024*768*60	60	48.363	65.000	1344	1024	136	160	806	768	6	29	-/+	DMT
1280*768*60	60	47.776	79.500	1664	1280	128	192	798	768	7	20	-/+	CVT
1280*960*60	60	60.000	108.000	1800	1280	112	312	1000	960	3	36	+/+	CVT
1280*1024*50	50	52.679	88.500	1680	1280	128	200	1057	1024	7	23	+/+	CVT
1280*1024*60	60	63.981	108.000	1688	1280	112	248	1066	1024	3	38	+/+	DMT
1360*768*50	50	39.564	69.000	1744	1360	136	192	793	768	5	17	+/+	CVT
1360*768*60	60	47.712	85.5000	1792	1360	112	256	795	768	6	18	+/+	DMT
1366*768*60	60	50.000	80.000	1600	1366	128	64	838	768	5	22	-/+	ORION(46")
1400*1050*60	60	65.317	121.750	1864	1400	144	232	1089	1050	4	32	-/+	CVT
1600*900*50	50	46.394	96.500	2080	1600	160	240	929	900	5	21	-/+	CVT
1600*900*60	60	55.990	118.250	2112	1600	168	256	934	900	5	26	-/+	CVT
1600*1200*50	50	61.795	131.500	2128	1600	168	264	1238	1200	4	31	+/+	CVT
1600*1200*60	60	75.000	162.000	2160	1600	192	304	1250	1200	3	46	+/+	DMT
480p	60	31.469	27.000	858	720	62	62	525	480	6	30	+/+	EDTV
576p	50	31.250	27.000	864	720	64	68	625	576	5	39	+/+	EDTV
720p50	50	37.500	74.250	1980	1280	80	220	750	720	5	20	+/+	HDTV
750p60	60	45.000	74.250	1650	1280	80	220	750	720	5	20	+/+	HDTV
1080i50	50	28.125	74.250	2640	1920	88	148	1125	1080	10	30	+/+	HDTV
1080i60	60	33.750	74.250	2200	1920	88	148	1120	1080	10	25	+/+	HDTV
1080p50	50	56.250	148.500	2640	1920	88	148	1125	1080	5	36	-/-	HDTV
1080p60	60	67.500	148.500	2200	1920	88	148	1125	1080	5	36	-/-	HDTV

9. Specification

MODEL		OLW-5550	
LCD PANEL	Diagonal	55"	
	Resolution	1920 x 1080	
	Brightness	700cd/m ²	
	Contrast Ratio	3,500:1	
	Power Consumption	350W	
	Backlight Type	LED	
	Acoustic Noise	Fanless Operation	
IMAGE PROCESSOR MODULE (Embedded Matrix Switcher)	Type	1 Module drives up to 4 LCD Panels	
	Maximum Image Scaling	Up to 9 x 4 (36 Sets) (Connecting up to 9 Image Processor Modules)	
	Video Input	DVI 1 - 4 IN (With HDCP), LOOP IN(DVI-D)	
	Video Output	RJ45 1 - 4 OUT (To Receiver Module), LOOP OUT(DVI-D)	
	Control	RS-232	1 IN/1 OUT
		Ethernet(RJ45)	1 IN
		LCD Panel Control (RJ45)	4 OUT
		Power Module Control (RJ45)	10UT
	Maximum Distance From LCD	40m (150m with Extender)	
	ETC	Status Display (LED, C-LCD) Rotary Switch	
Power	DC24V / 5A		
Case	19" Rack 1U		
RECEIVER MODULE	Video Input	RJ45 (From Image Processor Module)	
	Power	DC24V / 13A (From Power Supply Module)	
POWER SUPPLY MODULE	Type	1 Module drives up to 4 LCD Panels	
	AC Input	AC 100 ~ 240V, 50/60Hz	
	DC Output	DC24V / 5A 1 OUT(For Image Processor Module) DC24V / 10.5A 4 OUT(For Receiver Module)	
	Control	Power Module Control (RJ45) 1Input	
	Maximum Distance from LCD	40m	
	Status Display	LED	
Case	19" Rack 2U		

※Product design and specification can be changed for quality improvement without prior notice.

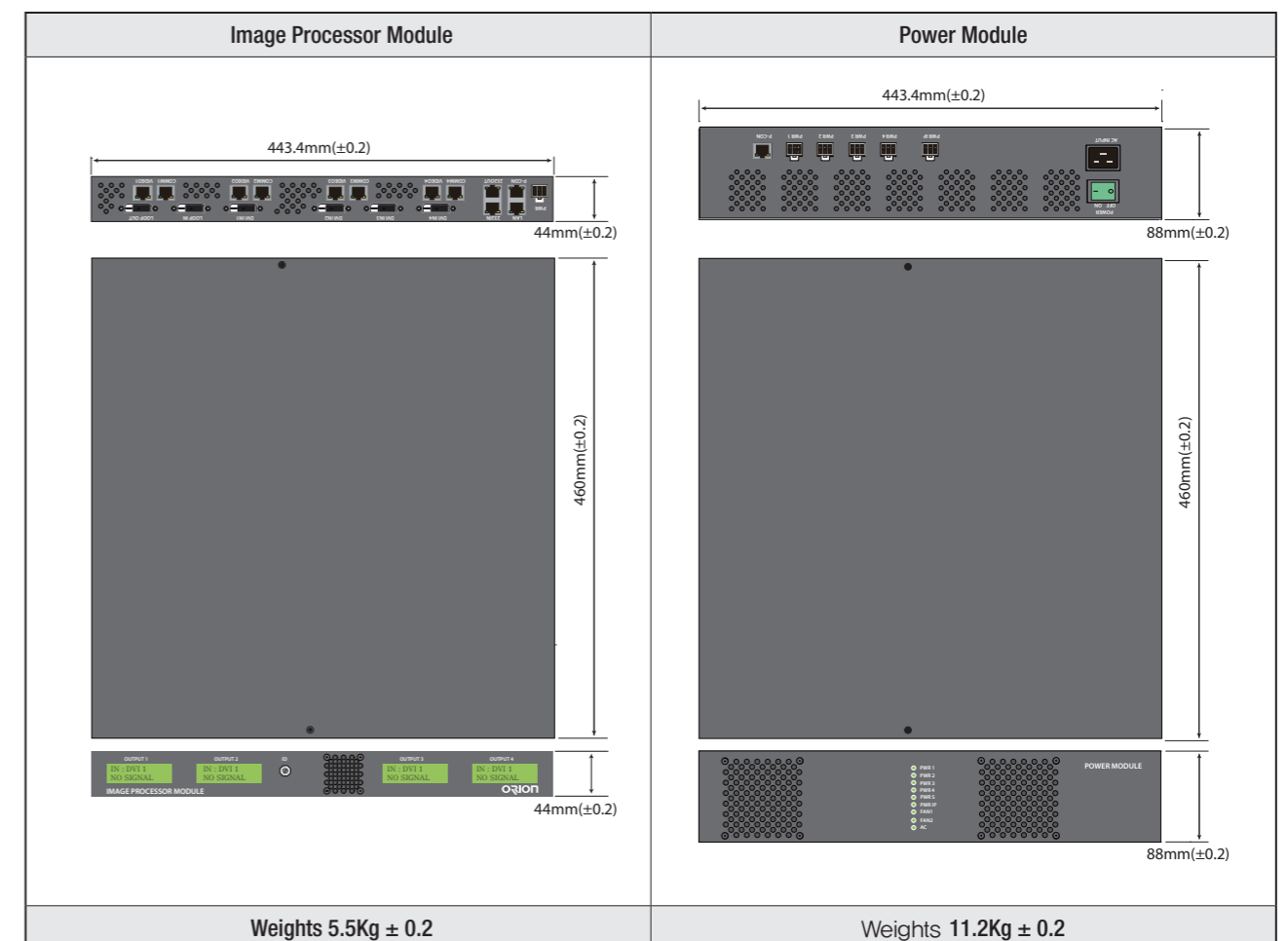
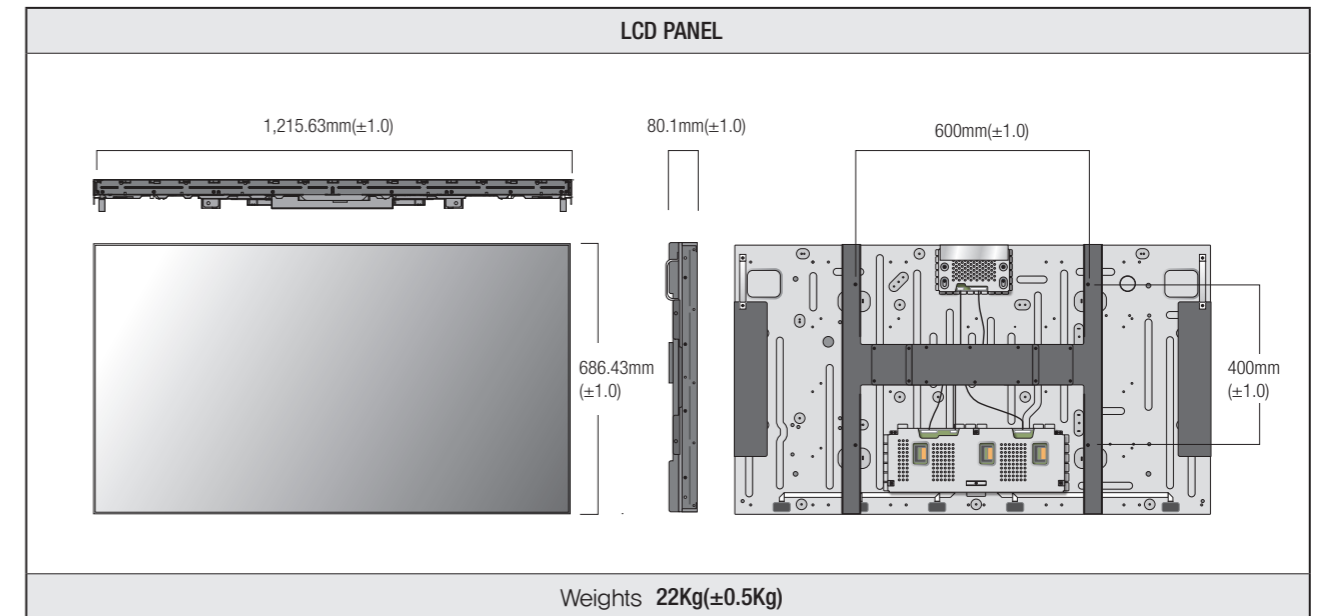

※Product design and specification can be changed for quality improvement without prior notice.

MEMO