

A revolutionary MLCD  
Infinitely Expandable MLCD

A revolutionary MLCD  
Infinitely Expandable **MLCD**

**ORION CO.,LTD.**  
[www.oriondisplay.net](http://www.oriondisplay.net)

Address: 257-6, Gongdan-dong, Gumi-si, Gyeongsangbuk-do, Korea  
Tel : +82-2-6678-8533, Fax: +82-2-6678-8599



**User's Manual**  
**OLM-4610 | OLM-4650 | OLM-4651**  
**OLM-5510 | OLM-5550**

Thank you for purchasing our MLCD.  
Please read through this user's manual for safety before installing this product.  
This product is manufactured for Multi LCD model only.

### Features of MLCD

- ▶ Enjoy a wide flat screen with high brightness and high quality.
- ▶ Easy to install and move due to its thin design
- ▶ Enjoy your favorite programs with various split-screen features simultaneously presenting several programs.

### Thank you for purchasing our MLCD monitor.

This manual describes how to use the product and notes in use.

Please read the manual carefully before using it.

After reading this manual, please retain for future reference.

If you have any questions or a problem occurs, please contact either the company you purchased this product from or an authorized service center.

※ **Displaying static picture for an extended period of time may cause a burn-in effect.**

※ **Burn-in effect and the faults in brightness and picture elements caused by fixed images are not subject to the warranty coverage.**



#### Warning

If you fail to comply with the regulations for safety and proper use, fire or injury may be caused.



#### Warning

To prevent electric shock, Do not remove cover.  
No user serviceable part inside  
Refer servicing to qualified service personal.

### Supplied Accessories

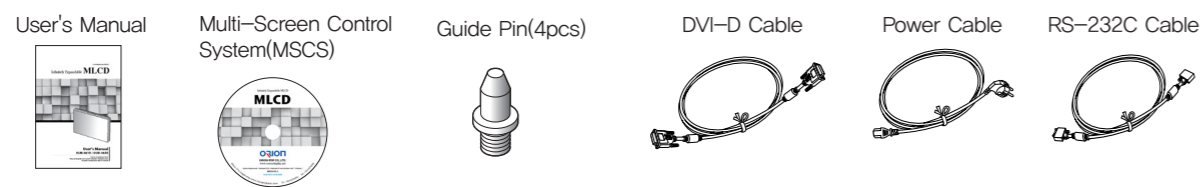

### Optional Accessories

**MAIN FRAME**  
(refer to page 14~15)

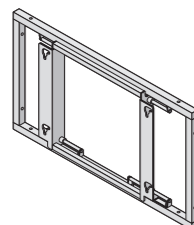

**DVI Converter**  
(ODC-10000)

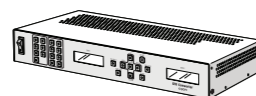

**New MFC SET**

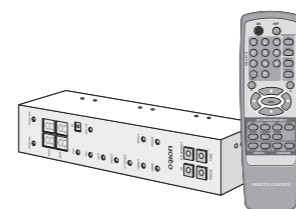

### Notice to users



#### Class A digital device

It is a device designed for business purpose with a safety certificate for electromagnetic interference, which user should be mindful of.

### " Important Safety Instructions"

- 1) Read these instructions.
  - 2) Keep these instructions.
  - 3) Heed all warnings.
  - 4) Follow all instructions.
  - 5) Do not use this apparatus near water.
  - 6) Clean only with dry cloth.
  - 7) Do not block any ventilation openings. Install in accordance with the manufacturer's instructions.
  - 8) Do not install near any heat sources such as radiators, heat registers, stoves, or other apparatus (including amplifiers) that produce heat.
  - 9) Do not defeat the safety purpose of the polarized or grounding-type plug. A polarized plug has two blades with one wider than the other. A grounding type plug has two blades and a third grounding prong. The wide blade or the third prong are provided for your safety. If the provided plug does not fit into your outlet, consult an electrician for replacement of the obsolete outlet.
  - 10) Protect the power cord from being walked on or pinched particularly at plugs, convenience receptacles, and the point where they exit from the apparatus.
  - 11) Only use attachments/accessories specified by the manufacturer.
  - 12) Use only with the cart, stand, tripod, bracket, or table specified by the manufacturer, or sold with the apparatus. When a cart is used, use caution when moving the cart/apparatus combination to avoid injury from tip-over.
  - 13) Unplug this apparatus during lightning storms or when unused for long periods of time.
  - 14) Refer all servicing to qualified service personnel. Servicing is required when the apparatus has been damaged in any way, such as power-supply cord or plug is damaged, liquid has been spilled or objects have fallen into the apparatus, the apparatus has been exposed to rain or moisture, does not operate normally, or has been dropped.
- The symbol in figure 21 shall be shown adjacent to the text of item 12 above.



	<b>CAUTION</b> RISK OF ELECTRIC SHOCK DO NOT OPEN	
<p><b>CAUTION : TO REDUCE THE RISK OF ELECTRIC SHOCK, DO NOT REMOVE COVER (OR BACK). NO USER-SERVICEABLE PARTS INSIDE. REFER SERVICING TO QUALIFIED SERVICE PERSONNEL.</b></p>		



This symbol is intended to alert the user to the presence of uninsulated "dangerous voltage" within the product's enclosure that may be of sufficient magnitude to constitute a risk of electric shock to persons.



This symbol is intended to alert the user to the presence of important operating and maintenance(servicing) instructions in the literature accompanying the appliance.

**NOTICE**

1. To disconnect the apparatus from the mains, the plug must be pulled out from the mains socket, therefore the mains plug shall be readily operable
2. WARNING - To Reduce The Risk Of Fire Or Electric Shock, Do Not Expose This Appliance To Rain Or Moisture.
3. Apparatus shall not be exposed to dripping or splashing and no objects filled with liquids, such as vases, shall be placed on the apparatus.
4. Use only a properly grounded plug and receptacle
5. "Warning" CAUTION – These servicing instructions are for use by qualified service personnel only. To reduce the risk of electric shock, do not perform any servicing other than that contained in the operating instructions unless you are qualified to do so.
6. "Warning" CAUTION – These servicing instructions are for use by qualified service personnel only. To reduce the risk of electric shock, do not perform any servicing other than that contained in the operating instructions unless you are qualified to do so.

**Contents**

※ Cautions for consisting MLCD System .....	4
※ Clearance for Ventilation .....	6
※ Do not cover the vent hole for the fan .....	7
※ Cleaning and Maintenance .....	7
※ Please keep following instruction for panel protection without exception.....	8
※ Handle with Caution.....	9
※ How to carry MLCD.....	10
※ Application information .....	11
1. Safety Precautions .....	12
2. How to Install .....	14
3. Guidance for Users.....	16
4. How to Connect Cables .....	18
4.1. Connection of Single MLCD.....	18
4.2. Connection of Multiple MLCD .....	20
4.3. Connection of Control Cable - In case of using MSCS.....	22
4.4. Connection of Control Cable - In case of using the other control program besides MSCS.....	24
4.5. Connection of DVI cable .....	26
4.6. Connention of optional accessory .....	27
4.7. ID setting of X x Y MLCD .....	28
5. Setting and operation of MSCS software .....	29
5.1. MSCS Installation .....	29
5.2. Start MSCS.....	30
5.3. Setting of COM Port.....	31
5.4. Setting of LAN Port (In case of connecting to a LAN Hub) .....	32
5.5. Setting of LAN Port (In case of connecting directly to user's computer).....	34
5.6. Network IP setting for MSCS .....	36
5.7. "New design/Last design" setting.....	37
5.8. Multi-screen configuration.....	38
5.9. Selecting the command transmission method.....	39
5.10. Changing the input source .....	40
5.11. Slide Control .....	43
5.12. Picture Control .....	46
5.13. Timer Control .....	47
5.14. Tracking Control .....	48
5.15. ORION Homepage log on and Version Information.....	49
6. Control Method of optional accessory .....	50
6.1. New MFC .....	50
6.2. DVI Converter .....	53
7. MSCS Protocol .....	61
※ Attachment : ASCII to HEX Conversion Table .....	77
8. Before calling for service .....	78
9. Applicable signals (DVI, PC).....	79
10. Specification .....	80
11. Option Specification .....	82
11.1. DVI Converter.....	82
11.2. New MFC.....	83

## ※ Cautions for consisting MLCD System

### The number of Daisy chain connection

- The image quality may vary depend on the quality of signal and cable condition.

INPUT SOURCE	Resolution	Connection	Remark
DVI	1600 x 1200 x 60Hz	6 sets	HDCP Available
PC	1600 x 1200 x 60Hz	3 sets	
Video	NTSC, PAL, SECAM	6 sets	
RS-232C		30 sets	ORION Cable Only

- If you need to use more MLCD sets than indicated in the table, using a DVI distributor is highly recommended.

### Caution for the other control program besides MLCD Control Program (MSCS)

- If you want to use automatic power on/off function that make MLCD turned on/off by connecting main power, allow at least 20 seconds of Stand-by time before MLCD is turned on, when you make control program.
- If RS-232C communication signal or other image signal is applied to 9 or more sets simultaneously, communicational error may occur. (Power on & Broadcast)

### Environmental condition for installation

- Since MLCD panel is very sensitive for physical impact, installation requires considerable caution.
- Minimum clearance(20cm) must be secured for smooth ventilation. (See page 6, 14~15) Installation must avoid air tight or near air tight places. Improper ventilation causes malfunction and shortens product lifetime by rapid internal temperature rise. If MLCD has to installed at the improper ventilation, additional ventilation openings or fans must be provided to keep the internal temperature between 0 ~ 35°C.
- For ground of MLCD and application devices, it should be connected as frame ground.
- Considering MLCD Max power consumption, check the main electric specification.

### Consideration for easier service

- When you design the exterior design for MLCD system, consider easier disassembly for possible service occasion in the future.
- The sliding Universal Unit of ORION is recommended for easier service.
- If service people can step into the backside of MLCD system, it can greatly reduce time and effort for service.
- In case of higher locations, consider the installation location and exterior design for easier service.

### ※ Clearance for Ventilation



- When you install MLCD, make sure there is at least 20cm clearance for effective ventilation and do not seal off MLCD sets.  
If MLCD sets are installed at the locations of bad ventilation, the inner temperature can be raised rapidly and it can cause frequent malfunctions and rapid reduction of the product life.

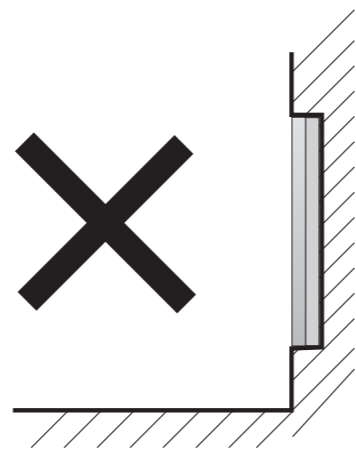
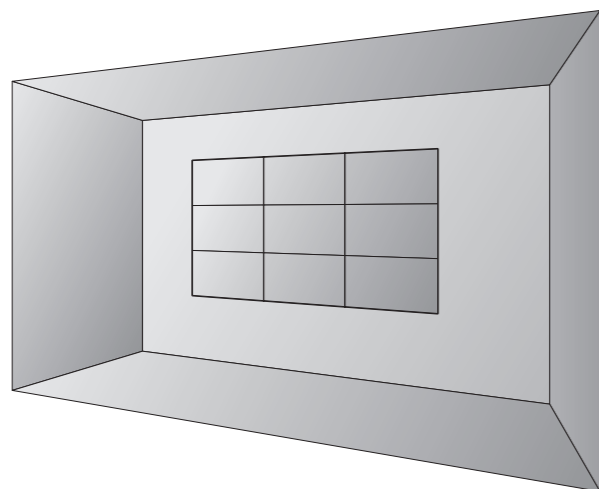
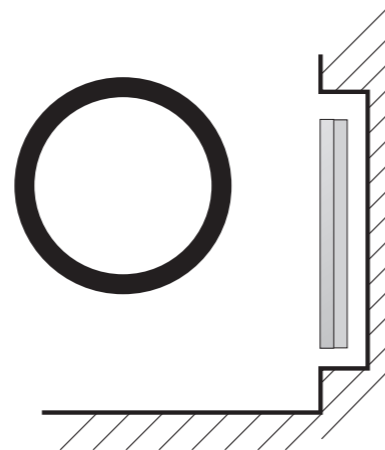
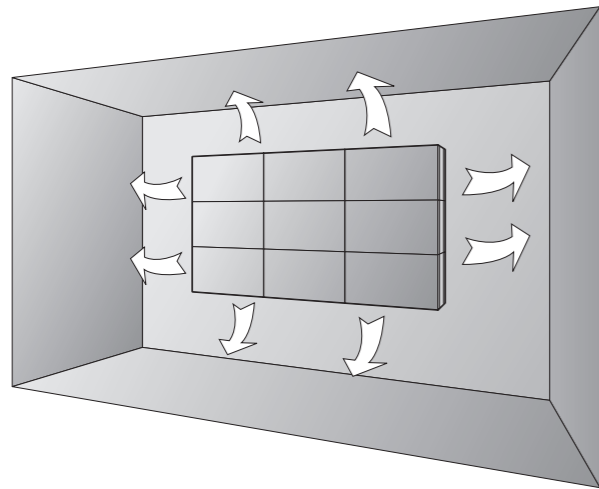

※ Ventilation space in front of MLCD must be furnished for heat dispersion. If the front space of MLCD has to be sealed, there must be consideration for the heat dispersion in the rear side of MLCD.

### ※ Do not cover the vent hole for the fan



- Carefully install MLCD not to cover the fan air holes with any structural object. If the holes are covered with anything, the inner temperature can be raised rapidly and it can cause malfunctions.

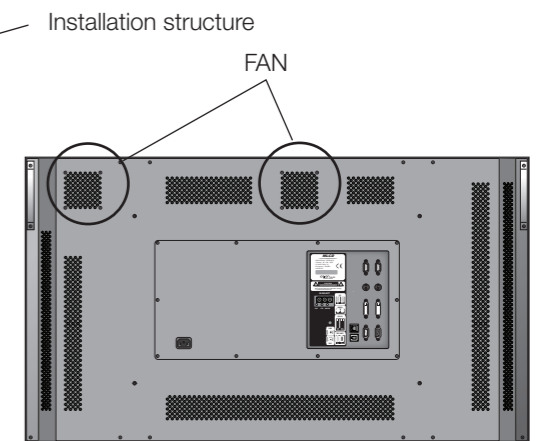
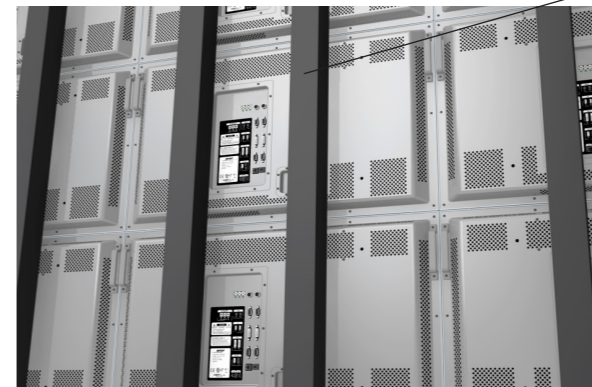

### ※ Cleaning and Maintenance



- Regularly clean off the vent holes in the back of MLCD sets. If the vent holes and the fan air holes are clogged with dust, it prevents the air flow inside of MLCD sets. It can cause rapid increase of the inner temperature and may cause malfunctions. Clean off the vent holes and the fan air holes with a vacuum cleaner regularly.

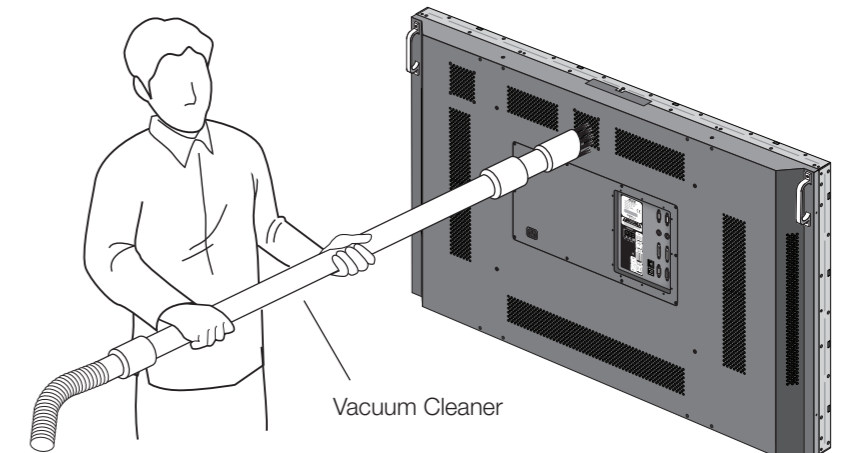

WARNING

WARNING

WARNING



※ Please keep following instruction for panel protection without exception.

- This product can be damaged even with minor impact for its nature. Please keep following instruction to carry or store the products.

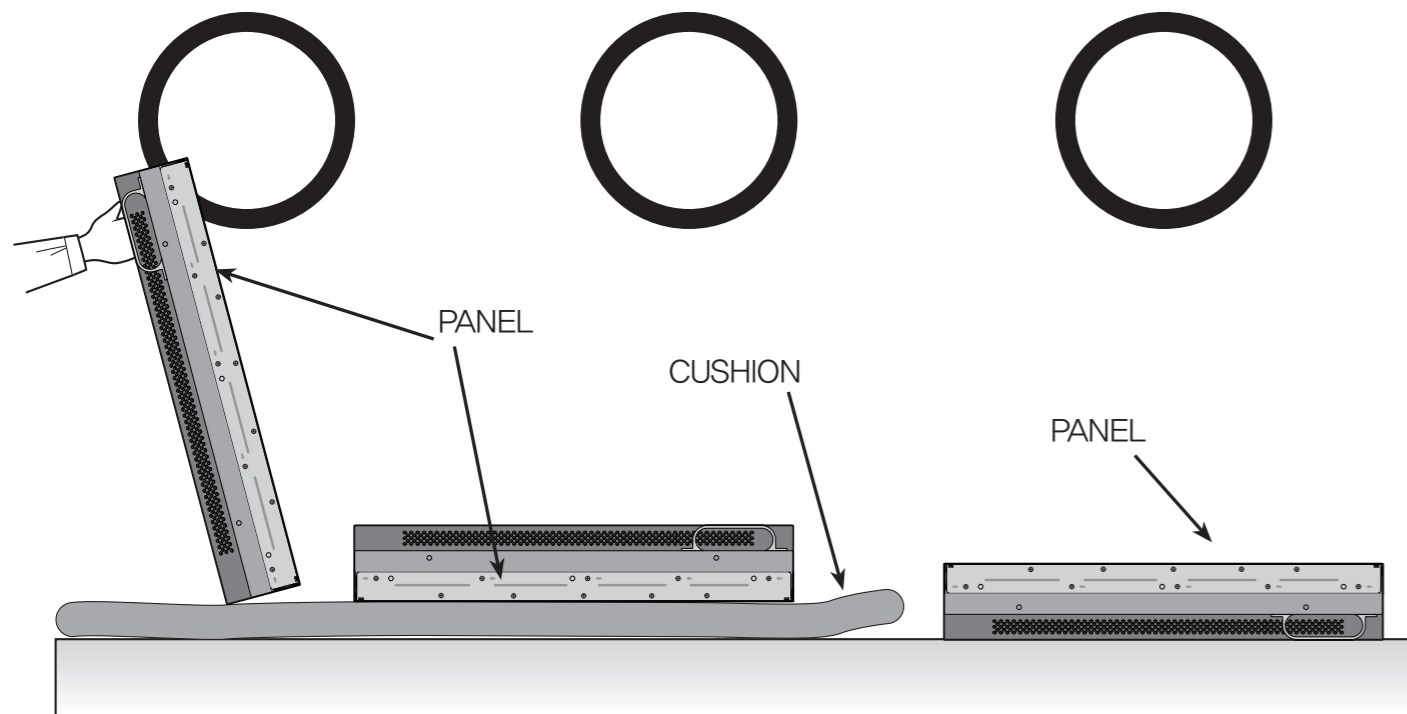

- If you need to stand LCD, you must use handles on the back and lean over the LCD to avoid panel touches ground or floor.
- If you need to lay down LCD as face down position, please use shock-absorbing pads under the LCD.
- If you need to lay down LCD as face up position, please be cautious for falling objects on the surface of the LCD.



※ Handle with Caution.

- Shock/Impact on the set's sides will result in internal circuit damages.
- The edge/bottom of the panel are fragile. Use shock-absorbing pads or rugs for laying down the product.

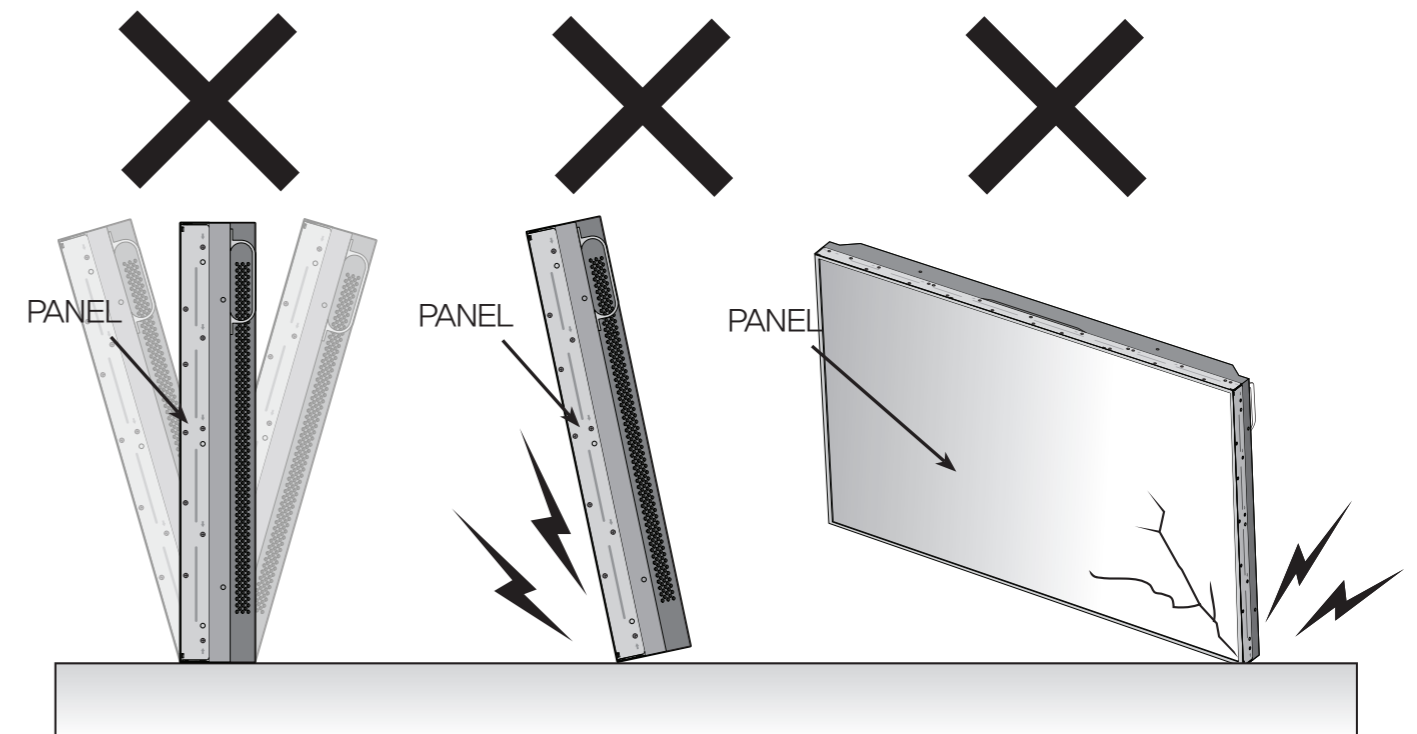

- Please do not stand LCD alone. It may fall or slip off and Panel can be broken or damaged.
- Please do not lean over the LCD. It may damage the bottom part of the LCD.
- Please do not lean over the LCD toward the edge part. It may damage the edge part of the LCD.

WARNING

### ※ How to carry MLCD

It always needs two persons to carry or install MLCD.

When you carry MLCD with up straight manner, please hold handles on the back and bottom part of the panel together.

Please be careful not to touch the bottom part of the panel when you put down the panel.

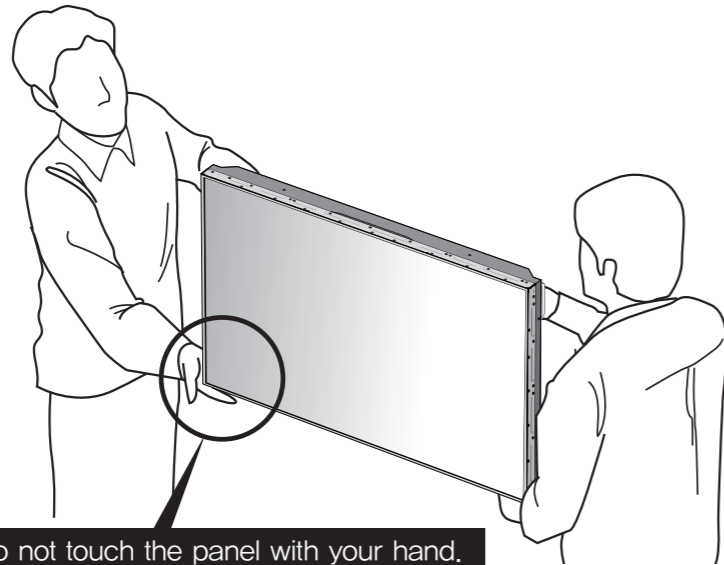

Please do not touch the panel with your hand.

When you carry MLCD with flatbed manner, please hold handles on the back and lower part of the back.

Please be careful not to touch the bottom part of the panel when you put down the panel.

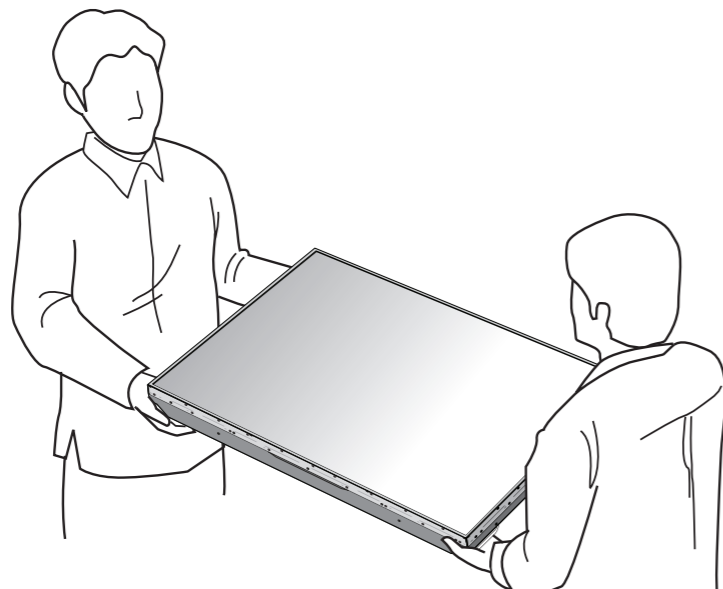

### ※ Application information

If static images are displayed on the screen for a long time, it causes burn-in image. Please keep the following instruction to optimize the lifetime and functions of the product.

#### 1. Operating condition

- Temperature: 20 ± 15°C
- Humidity: 55 ± 20 %
- Display pattern: moving picture or regular switchover display
- Environmental condition : Well ventilated place is recommended.
- Power off and screen saver : Periodical power-off or screen saver is needed after long-term static display.

※ Note : Moving picture or black pattern is strongly recommended for screen saver.

#### 2. Operating methods to minimize burn-in image due to long-term static information display

- Suitable operating time : under 20 hours a day.
- Periodical display contents change from static image to moving picture.
- Periodical background color and character (image) color change

DEPARTURE			DEPARTURE		
Flight No.	Time	Gate	Flight No.	Time	Gate
UA 012	11:20	A02	UA 012	11:20	A02
KE 732	12:10	K17	KE 732	12:10	K17
AN 291	12:45	F11	AN 291	12:45	F11

- Change the images of little luminance difference between the background and characters, periodically.

DEPARTURE			DEPARTURE			DEPARTURE			DEPARTURE		
Flight No.	Time	Gate	Flight No.	Time	Gate	Flight No.	Time	Gate	Flight No.	Time	Gate
UA 012	11:20	A02	UA 012	11:20	A02	UA 012	11:20	A02	UA 012	11:20	A02

- It is not recommended to display the images of huge luminance difference between the background and characters or the images of grey tone.

ARRIVAL				ARRIVAL			
Flight No.	Time	Gate	Delay	Flight No.	Time	Embark	Delay
AA 213	9:20	K11	On time	AA 213	9:20	New York	On time
OZ 621	11:25	G21	10 min.	OZ 621	11:25	Seoul	10 min.
JA 032	12:05	A19	On time	JA 032	12:05	Beijing	On time

- Scroll the characters periodically.

DEPARTURE			DEPARTURE DEPARTURE DEPARTURE			DEPARTURE		
Flight No.	Time	Gate	Flight No.	Time	Gate	Flight No.	Time	Gate
UA 012	11:20	A02	UA 012	11:20	A02	UA 012	11:20	A02
KE 732	12:10	K17	KE 732	12:10	K17	KE 732	12:10	K17
AN 291	12:45	F11	AN 291	12:45	F11	AN 291	12:45	F11

(Whole Screen Scroll)

# 1. Safety Precautions

- If it operates abnormally, stop using it immediately.

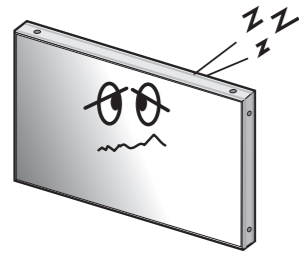

- Do not place any liquid-containing container on it. If the inside is wet, it may cause electric shock or fire.

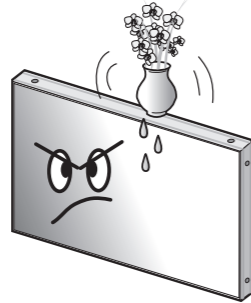

- Do not put any foreign material into the product. It may cause a failure or shorten the life span.

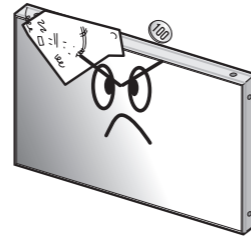

- Please refer to a specialized construction company for installing stand or wall mount unit. Otherwise, damage or injury may be caused.



- Do not touch the device when lightning strikes.

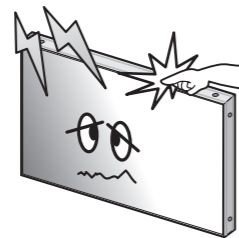

- Do not install in an unstable location. It may cause injury.

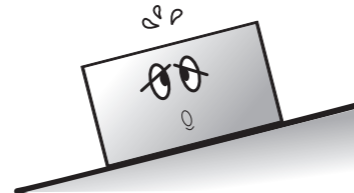

- Avoid any action to damage the power cord or power plug. It may cause fire or electric shock.

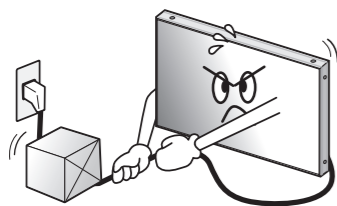

- Do not pull out the power plug with a wet hand. It may cause electric shock.



- Do not exceed ratings of AC outlet or extension cords. It may cause failure.

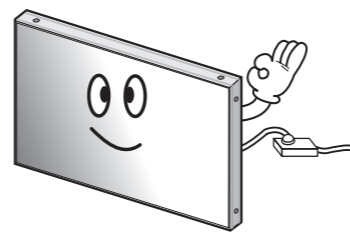

- Do not alter (or disassemble) the product. It may cause electric shock since high voltage is flowing inside.

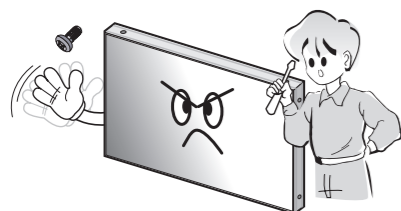

- Do not install the product where it may be exposed to direct sunlight or near any heating device. It may shorten the product's life span or cause failure.

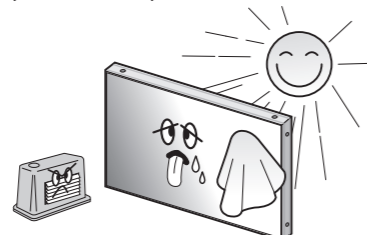

- Make sure the product is not covered with any object. If the ventilation hole is blocked, the inside temperature may rise to cause overheating resulting in fire.



- Do not pull out or hang down the connection cable. It may damage the cord to cause fire or electric shock.

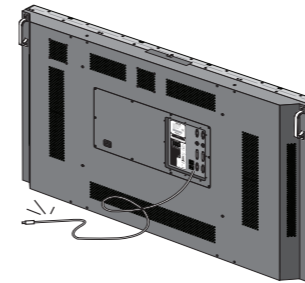

- Do not lean against the product or keep it leaned. It may cause injury or failure.

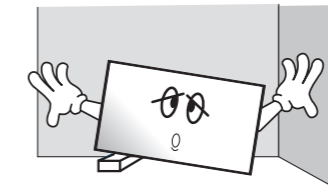

- Do not put it at any place with much humidity, dust, oil, smoke or steam. It may cause failure.

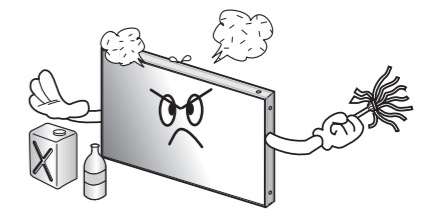

- Pull out the power plug by holding the plug. Otherwise, it may damage the power cord to cause fire or electric shock.

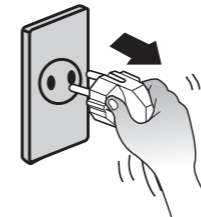

- If you do not want to use the product for a long time, keep the power plug unplugged to save electricity.
- The socket-outlet should be installed near the equipment and be easily accessible.

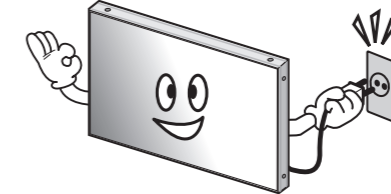

- Do not put any heavy object on it. It may cause failure.

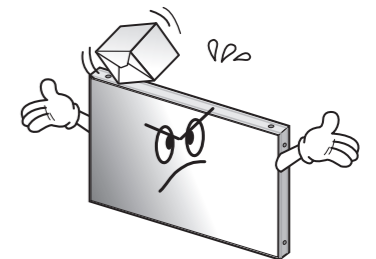

- Install the product on safe and flat surface.

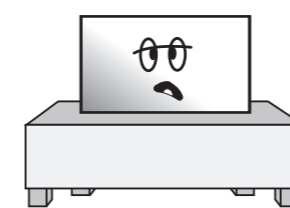

- Do not ride or step on the product. It may cause breakage when fallen down.

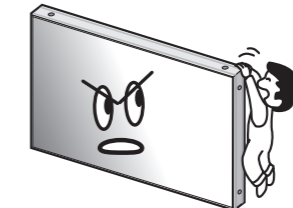

- When moving it, disconnect the connecting cable. Otherwise, it may damage the cable to cause fire or electric shock.

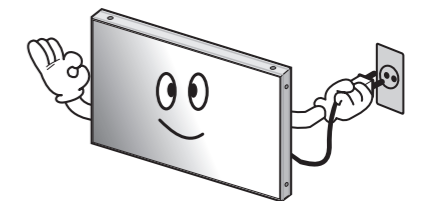

- Do not put candles on the product. If the liquid flows inside the product. It may cause electric shock or fire.

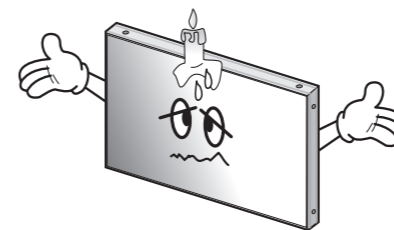

- Do not touch product's front surface with hand. Otherwise, the image quality can be lowered.

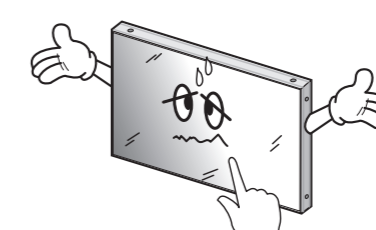

- Do not poke the front screen with sharp material. It may damage the screen and may cause malfunction of the product.

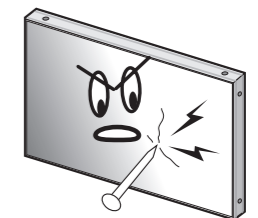



## 2. How to Install

### MAIN FRAME Stand Unit (Option)

- Please do not install our product at following locations to protect the product and prevent possible malfunction.
  - Places of vibration or shock: LCD set may fall and damaged
  - Next or near to Sprinkler sensors: The sensors may detect heat from a set and sprinkler can be activated.
  - Around high voltage power lines: Noise from the power line may affect screen images
  - Around heating apparatus: LCD set may be overheated and damaged.
- The set can be installed as shown below.  
(For further information, refer to the optional 'MAIN FRAME Installation and Setup Guide'.)

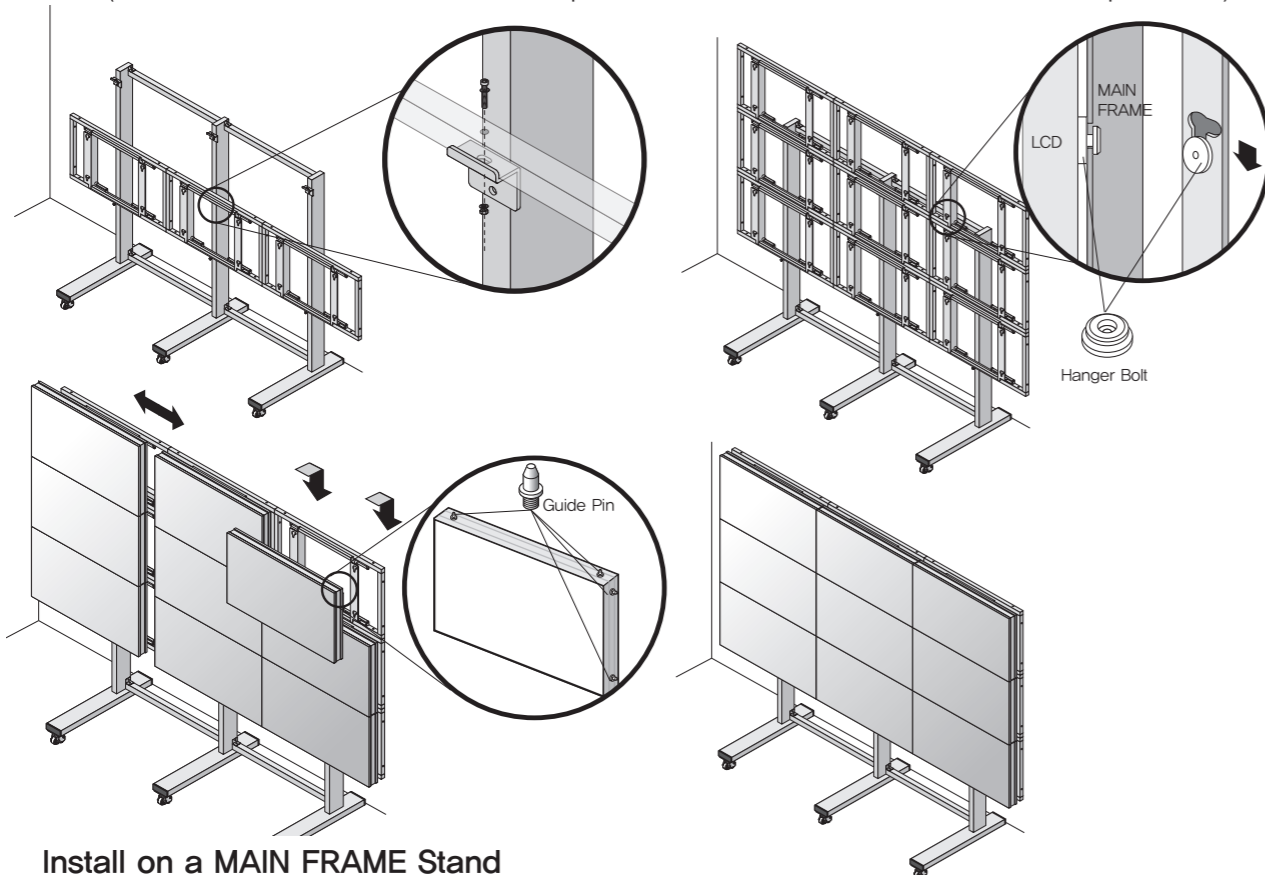

#### Install on a MAIN FRAME Stand

Please secure minimum clearance as shown in the picture for adequate ventilation and technical service.

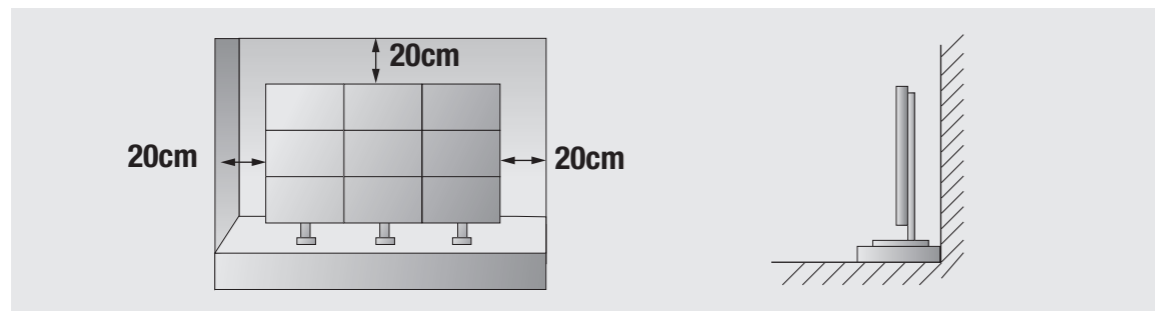

### MAIN FRAME Wall Mounting Unit (Option)

- Please check the stability of wall.  
If the wall is not strong enough, reinforce the wall before installation.
- Please connect all the cables to proper ports in a set before installation.
- The set can be installed on the wall as shown below.  
(For further information, refer to the optional 'MAIN FRAME Installation and Setup Guide'.)

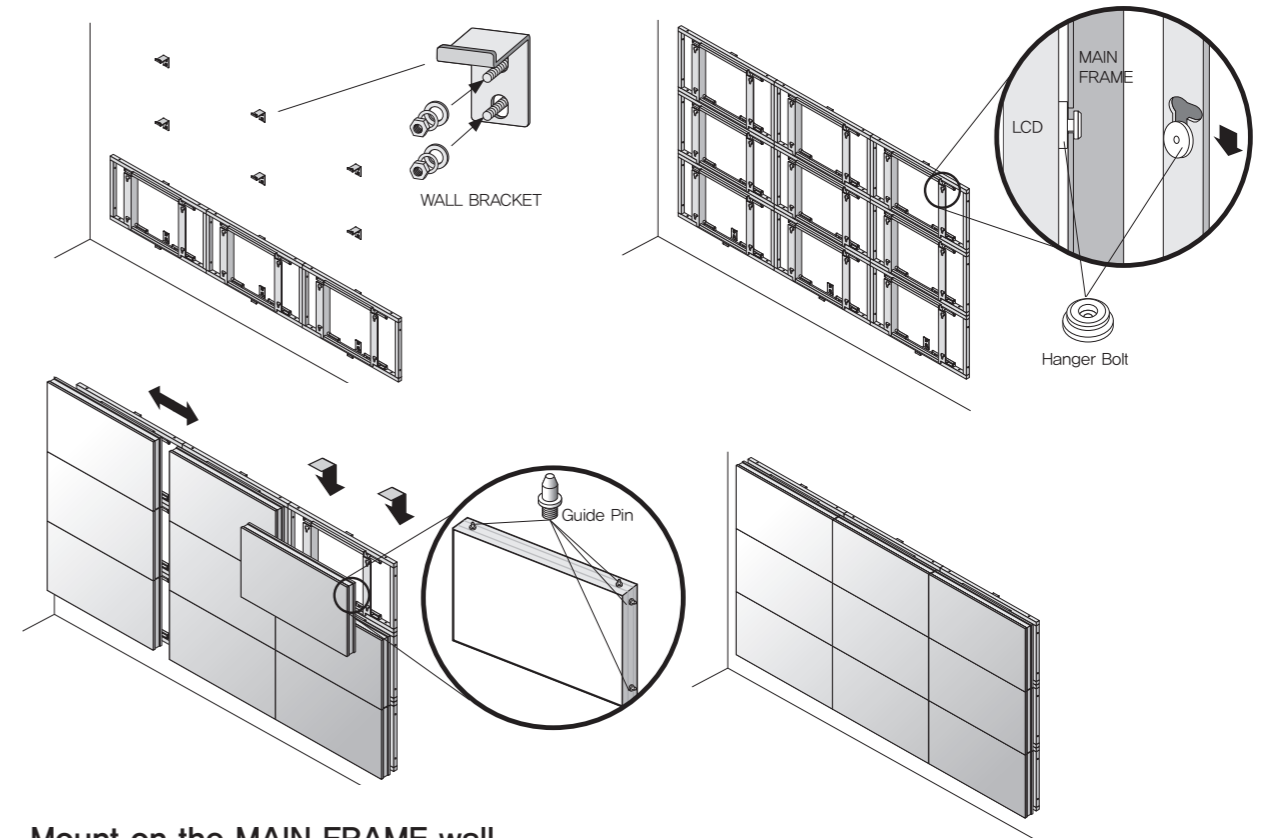

#### Mount on the MAIN FRAME wall

Please secure minimum clearance as shown in the picture for adequate ventilation and technical service.

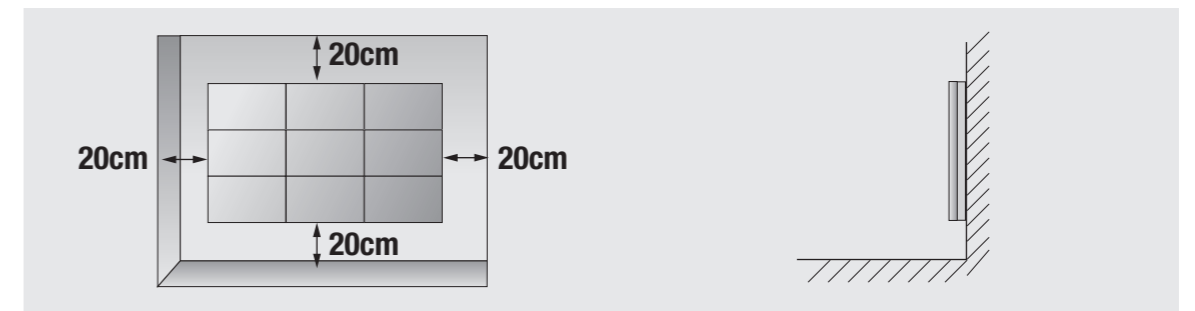

### 3. Guidance for Users

#### Input/Output Terminals

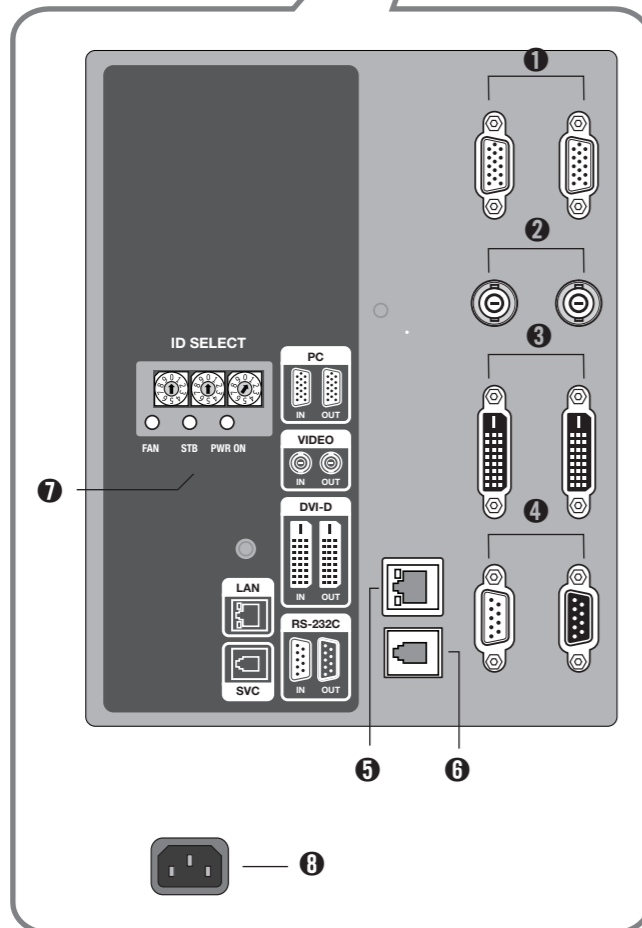
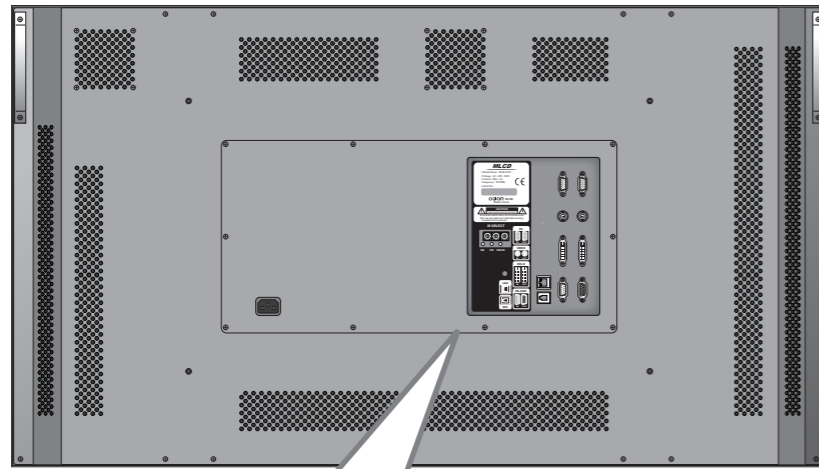

- 1.PC In / Out**  
Analog RGB Signal,  
D-sub 15pin
- 2.VIDEO**  
Composite Signal, BNC Jack
- 3.DVI**  
Digital RGB Signal,  
DVI Single Link 24Pin
- 4.RS-232C**  
MLCD Control, Firmware  
Upgrade, D-sub 9pin
- 5.LAN**  
Ethernet Control, RJ45
- 6.Service Port**  
For the exclusive use of service
- 7.ID Switch**  
Set ID Switch
- 8.AC Input**  
AC 100V ~240V, 50/60Hz

※ The product shape may vary depending on the model.

#### Set ID Switch Setting

- Example of ID Switch setting
- You can set ID with 3 rotary switches as shown in the following figure.

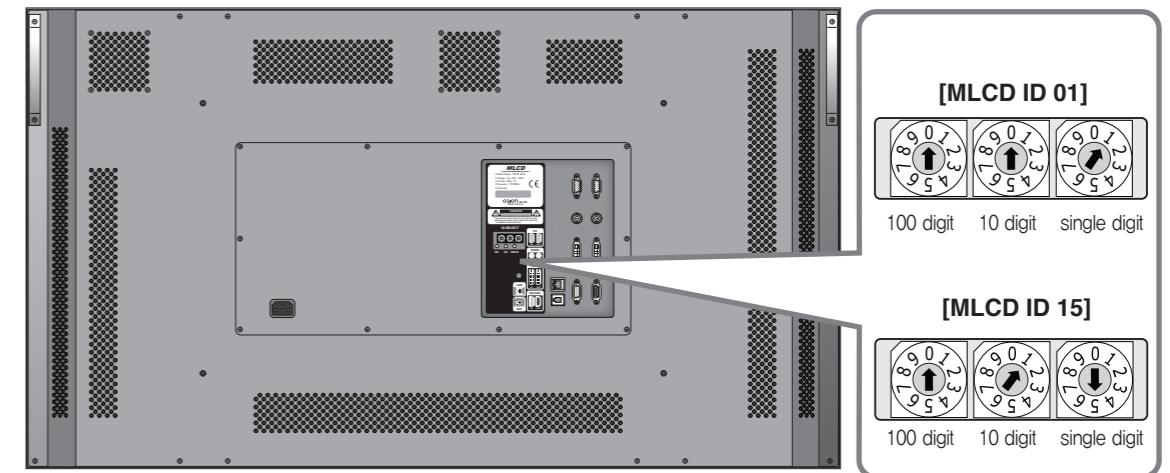

- ※ When you set ID of MLCD set, power cable must be disconnected. If power cable is not disconnected during ID setting, MLCD set may be operated with the previous ID and it may cause abnormal behavior.
- ※ For stable operation, wait for at least 10 seconds prior to use MLCD control program after the first AC power connection.

• LED Indication ON ○ OFF ● BLINKING ●

LED Indication	Description
	No Power.
	Insert power cord(Stand-By state)
	Power On By MSCS. The PWR ON LED blinks continually.
	Power Off by MSCS Program. (System ready).

FAN : Normal - LED Off, Abnormal - LED On  
IF FAN LED is turned on, please check FANs.

## 4. How to Connect Cables

- Do not connect/disconnect cables while MLCD or other external equipments are turned on.
- First turn off the power all the attached equipment and make connections.
- Make sure the power cord is inserted properly into the power inlet to prevent unexpected pullout of the cord.

### 4.1. Connection of Single MLCD

- MLCD and PC should be connected; a Com Port in a PC and RS-232C IN port in a MLCD is connected with supplied RS-232C cable.
- MLCD On/Off or Screen adjustment can be controlled by MSCS (Multi-Screen Control System).
- ID setting on the backside of MLCD must be identical with the ID setting in MSCS to control MLCD with a PC.
- If you do not have Com Port, you need to use a USB converter for RS-232C. Depending on manufacturers or models, converters may cause malfunction.

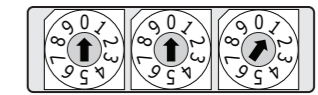
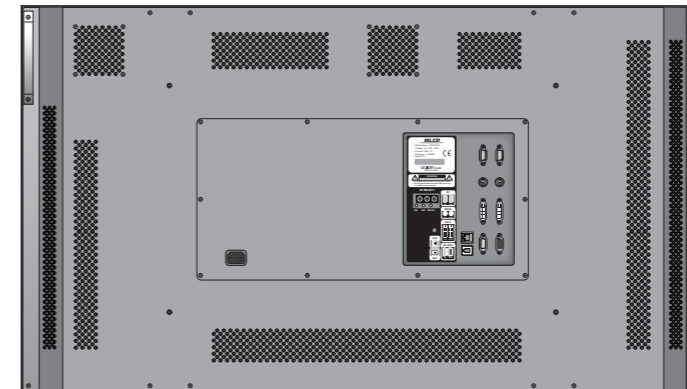
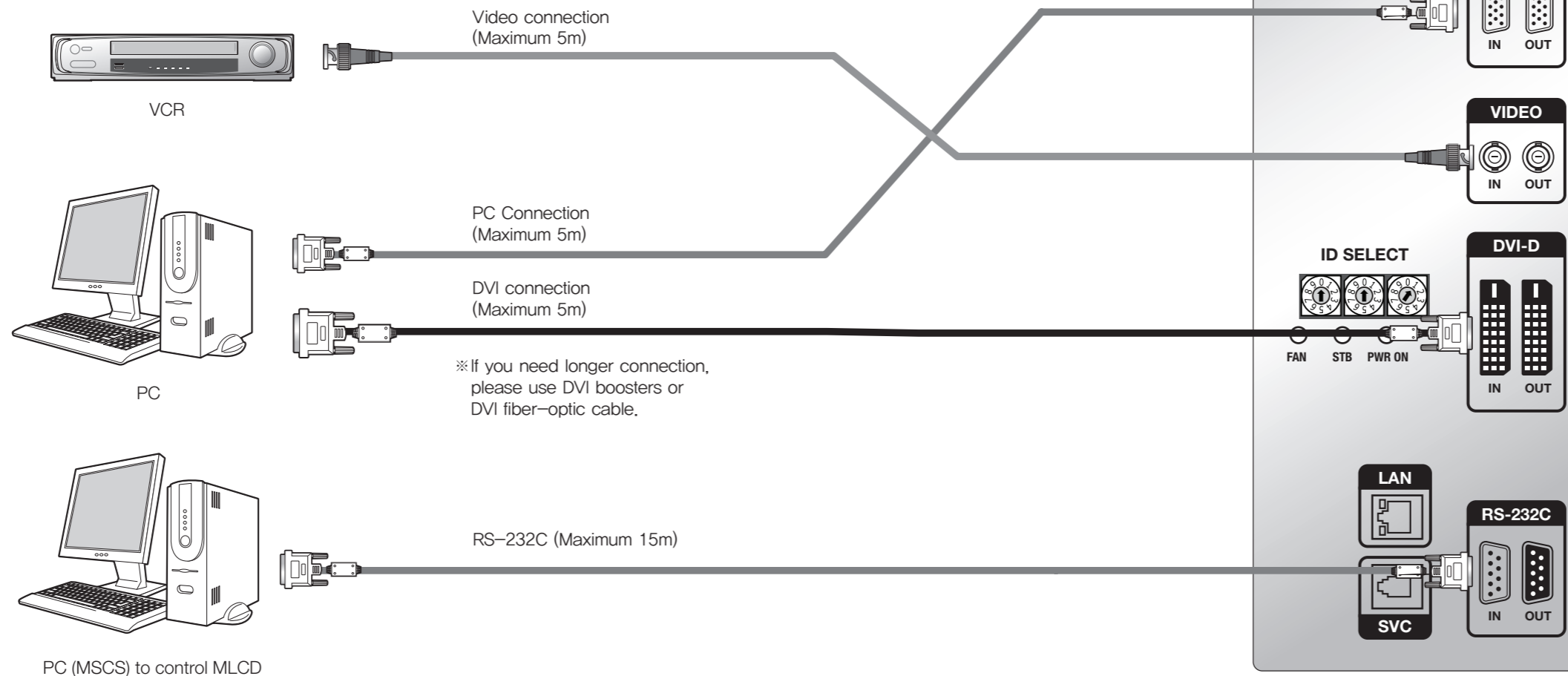

[MLCD ID 01]

- ID switch must be set as ID 1 for one set use.

### 4.2. Connection of Multiple MLCD

- Recommended maximum set connection for Multi setting is shown in table below. If you need to connect more than described in the table, you have to use distributors.
- Image quality can be affected by cable or signal quality.

INPUT SOURCE	Resolution	Connection	Remark
DVI	1600 x 1200 x 60Hz	6 sets	HDCP Available
PC	1600 x 1200 x 60Hz	3 sets	
Video	NTSC, PAL, SECAM	6 sets	
RS-232C		30 sets	ORION Cable Only

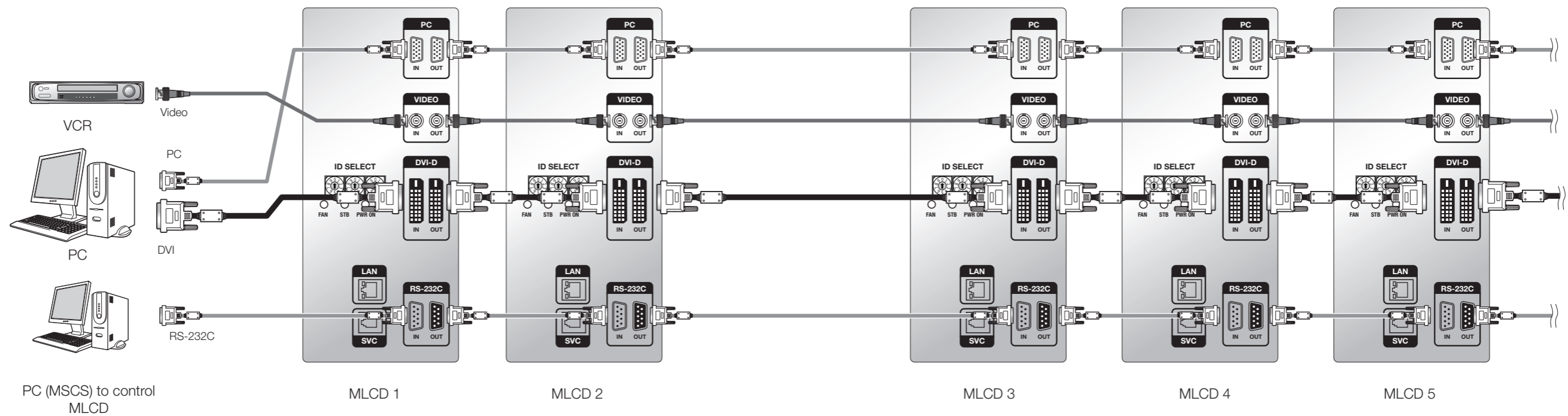
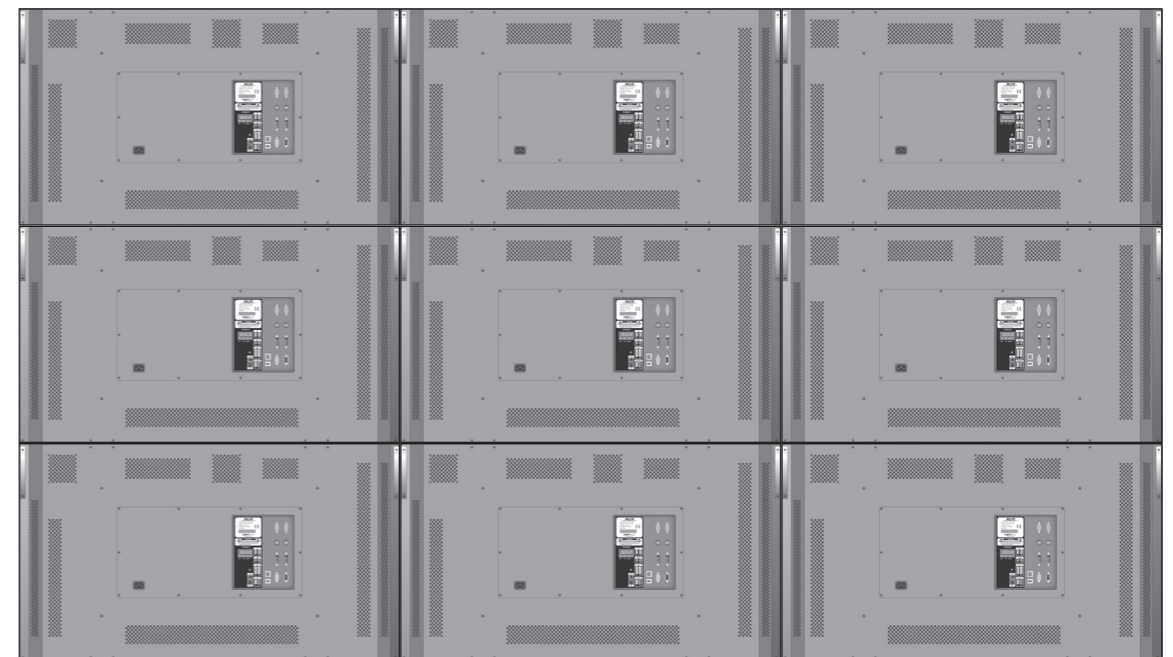

### 4.3. Connection of Control Cable - In case of using MSCS

- Control signal transmission can be connected by 2 different methods. (RS-232C or Ethernet)
- RS-232C and Ethernet connection cannot be used simultaneously.

#### 4.3.1. Connection of RS-232C Cable

- Maximum use of RS-232C with Daisy Chain connection is 30 sets or less, if you need additional connection, use RS-232C distributor.

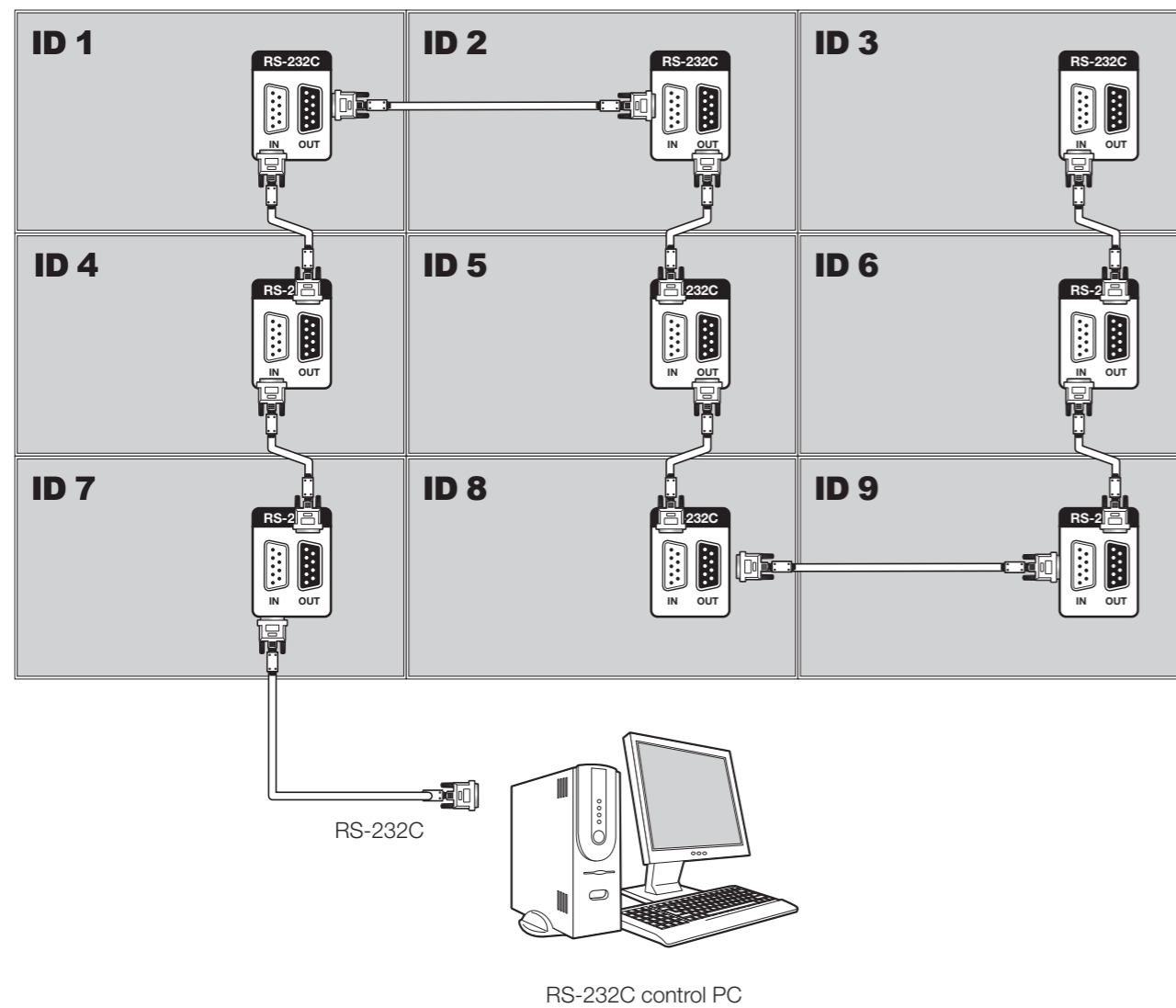

#### 4.3.2. Connection of Ethernet Cable

- In case of Ethernet connection, the control PC should be connected to one of MLCD sets with Ethernet cable. For the connection between the MLCD sets, they should be connected with RS-232C cables.

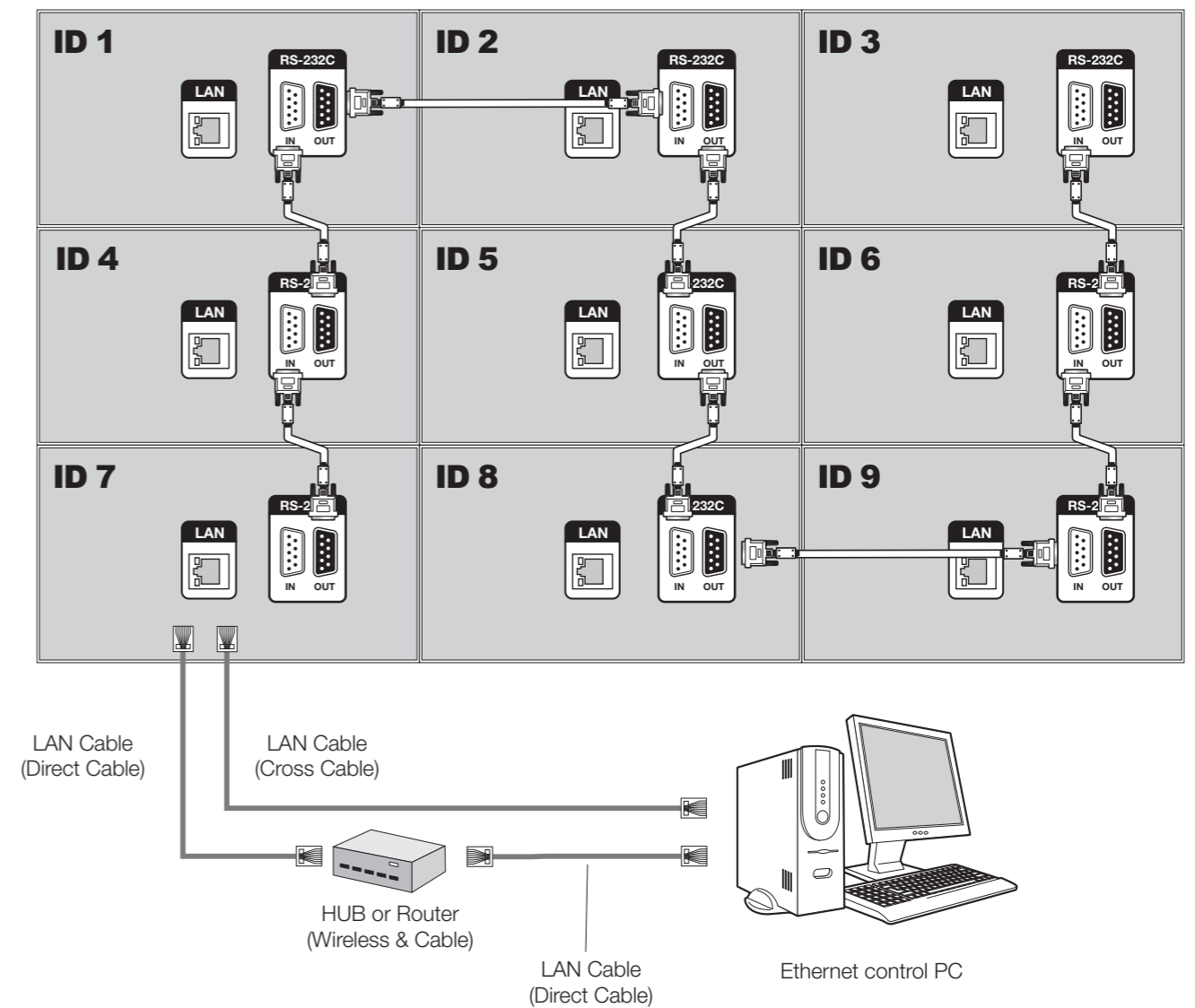

### 4.4. Connection of Control Cable - In case of using the other control program besides MSCS

※ If you use the other screen control program besides MSCS, the signal cable must be connected via MFC (Multi- Function Controller) of ORION.

- Control signal transmission can be connected by 2 different methods. (RS-232C or Ethernet)
- RS-232C and Ethernet connection cannot be used simultaneously.

#### 4.4.1. Connection of RS-232C Cable

- The RS-232C signal cable must be connected via MFC.
- Maximum use of RS-232C with Daisy Chain connection is 30 sets or less, if you need additional connection, use RS-232C distributor.

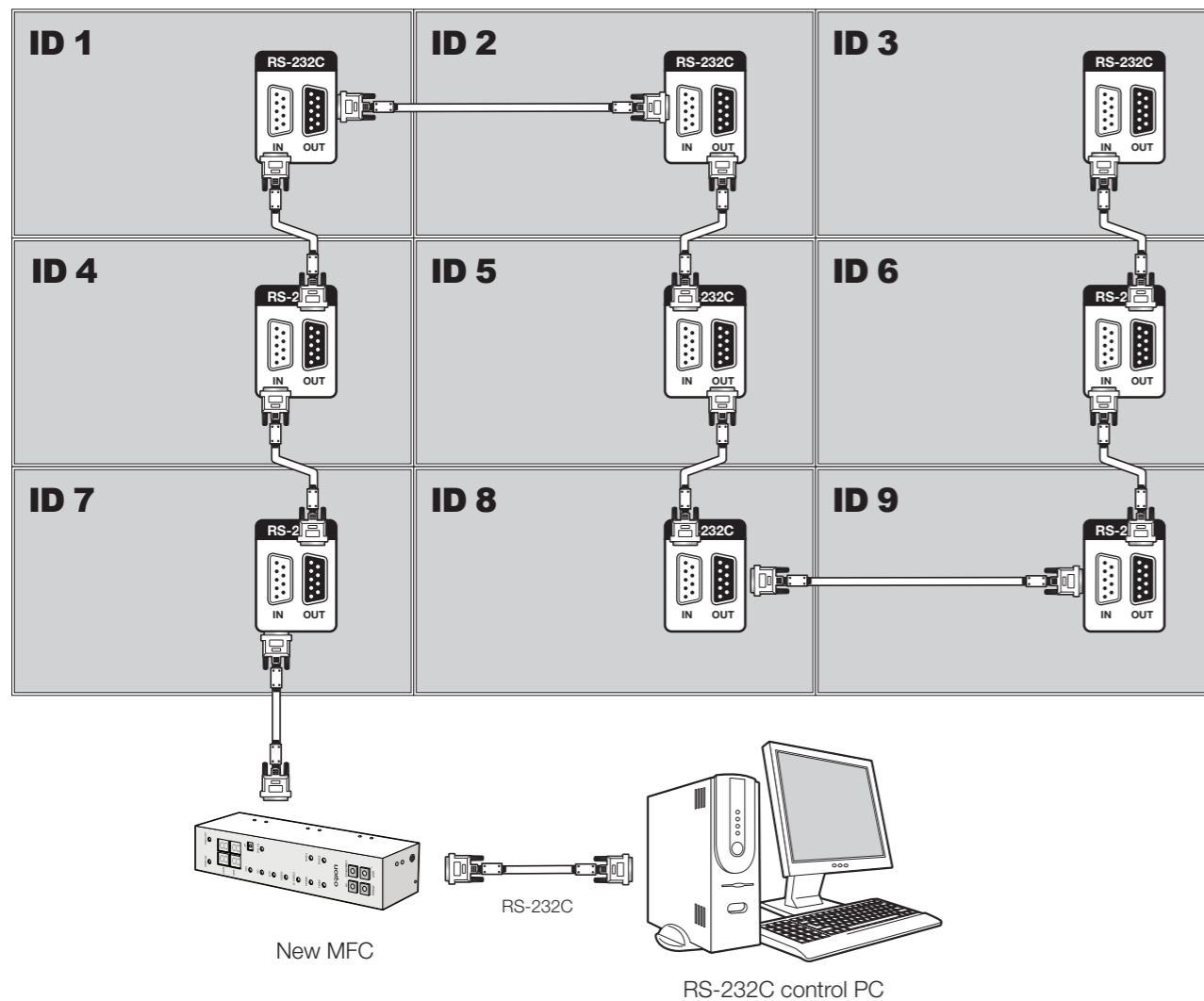

#### 4.4.2. Connection of Ethernet Cable

- If you want to control MLCD sets with Ethernet, PC and MFC can be connected with Ethernet cable and between MFC and the first MLCD set and between the other MLCD sets should be connected with RS-232C cable.

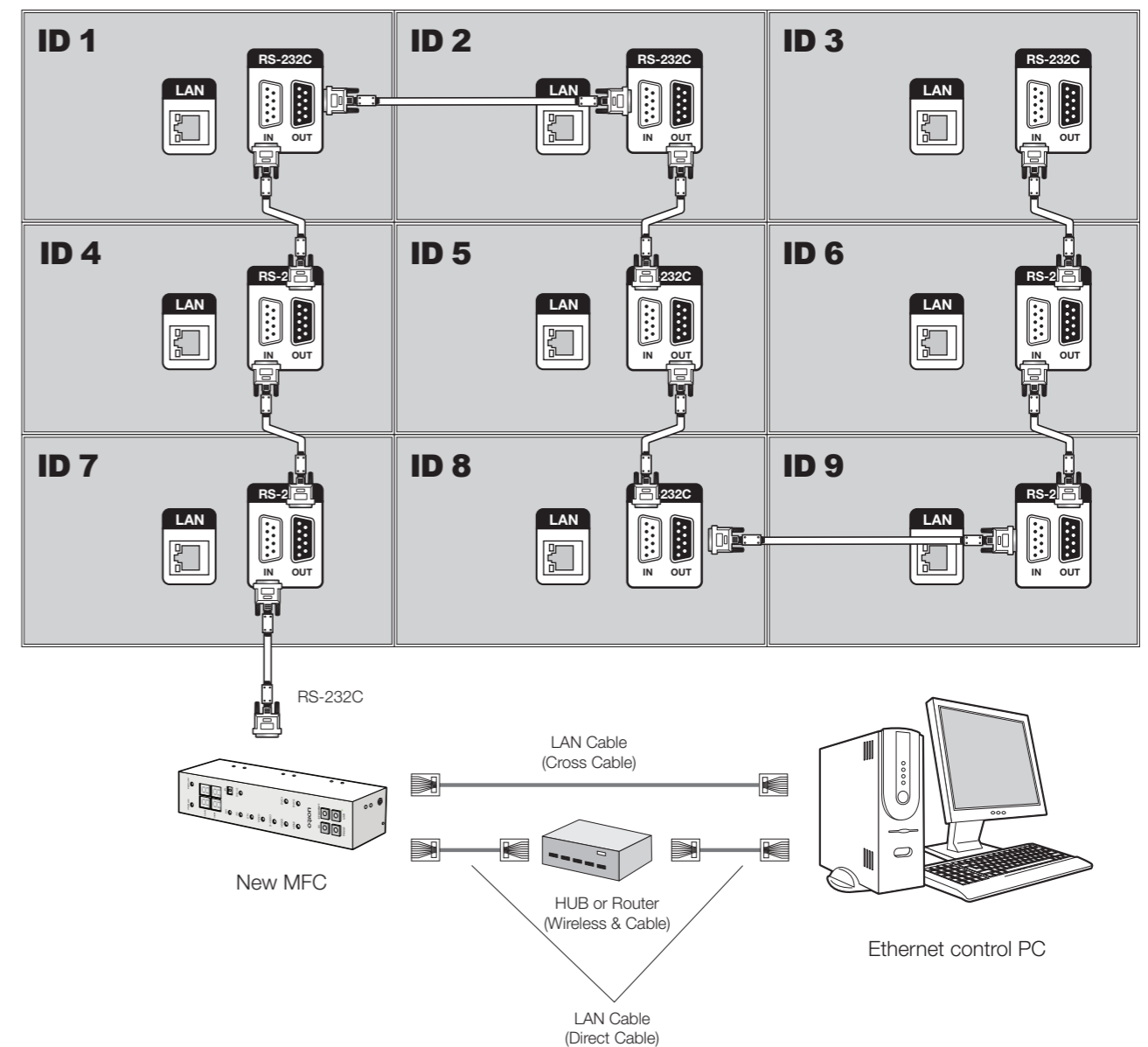

4.5. Connection of DVI cable

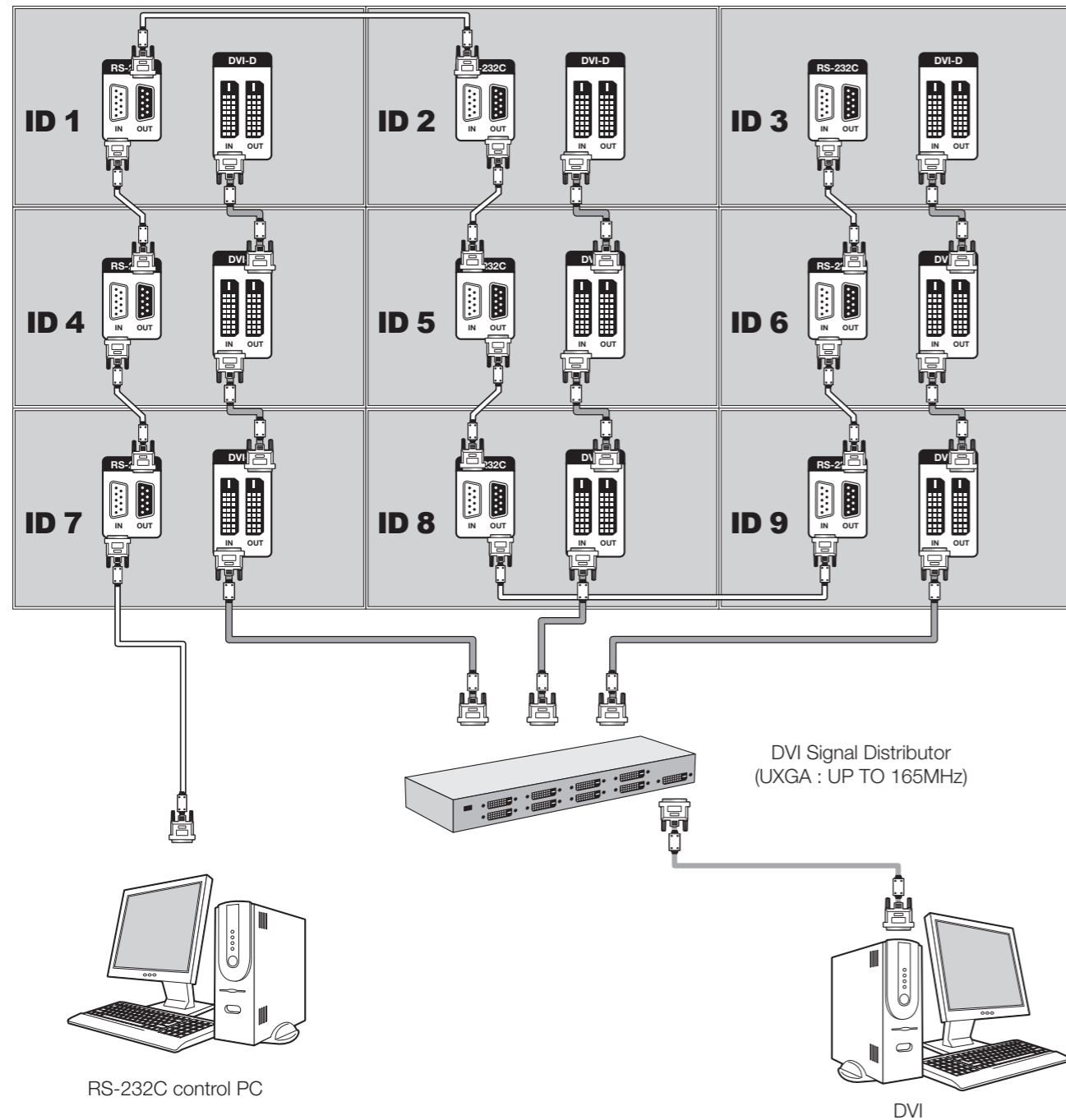

RS-232C control PC

DVI

※ Caution for DVI Distributor

If you want to display HDCP (High-bandwidth Digital Content Protection) applied contents, you must use the distributor that supports HDCP function.

4.6. Connection of optional accessory

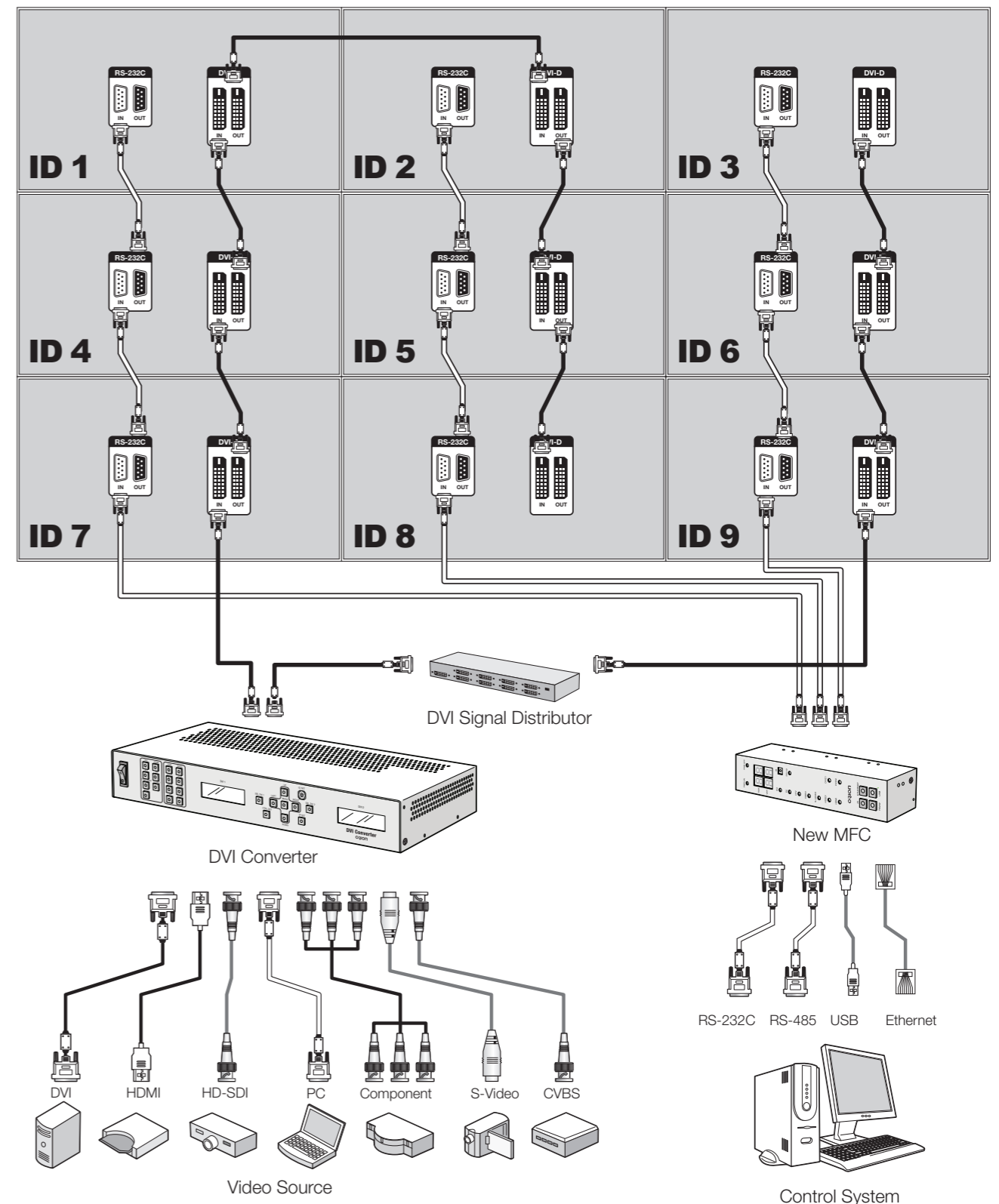

DVI Signal Distributor

DVI Converter

New MFC

RS-232C RS-485 USB Ethernet

Video Source

Control System

### 4.7. ID setting of X x Y MLCD

- Identity number (ID) indicates the location of each MLCD.
- When you look at the MLCD screens in front of MLCD.

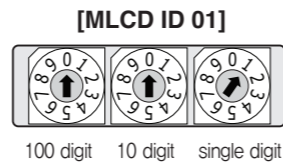

LCD ID 1	LCD ID 2	LCD ID 3	LCD ID 4	LCD ID 5
LCD ID 6	LCD ID 7	LCD ID 8	LCD ID 9	LCD ID 10
LCD ID 11	LCD ID 12	LCD ID 13	LCD ID 14	LCD ID 15
LCD ID 16	LCD ID 17	LCD ID 18	LCD ID 19	LCD ID 20
LCD ID 21	LCD ID 22	LCD ID 23	LCD ID 24	LCD ID 25

Recommended ID of X x Y screens

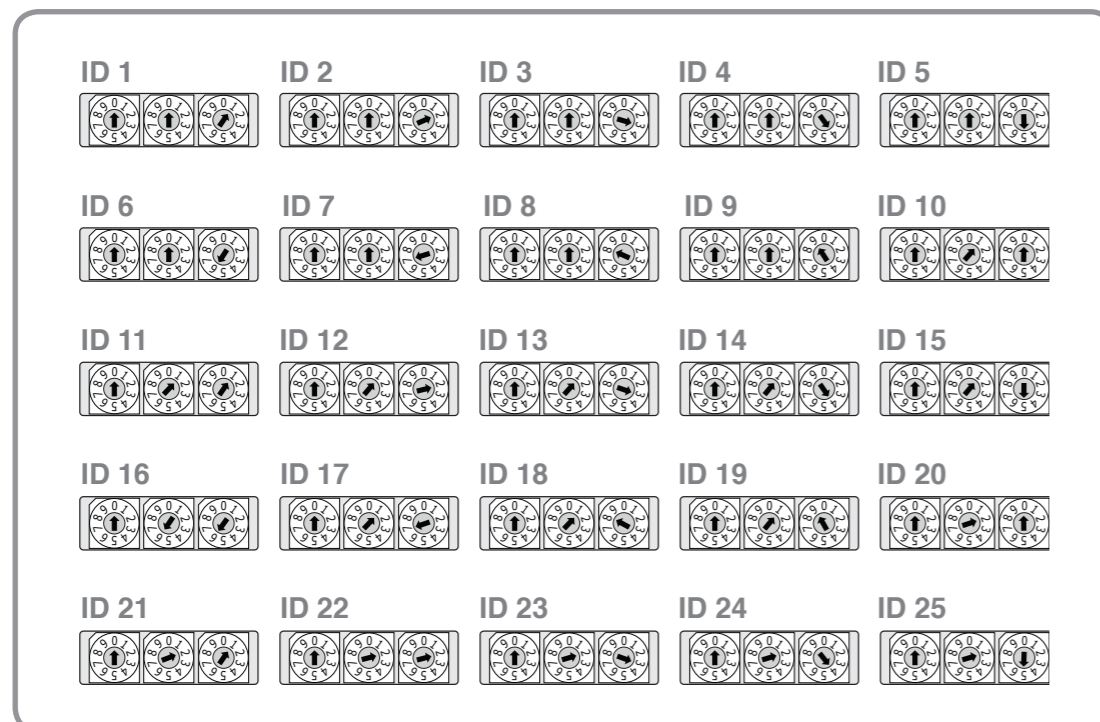

## 5. Setting and operation of MSCS software

### 5.1. MSCS Installation

- Insert the Installation CD.
  - You can see following installation start screen.
  - Select proper version for your product and start installation
- MSCS supports Windows® 2000, Windows® XP and Windows® Vista, Windows® 7™ only



MSCS Installation start screen.

※ MSCS Versions can be changed for function improvement without prior notice.



#### Caution for using MSCS

1. Data for Picture control, Manual Tracking and so forth can be read by clicking the right button of your mouse on the desired MLCD set from MSCS. Please do not use above function together with the other functions.
2. When you off AC power, execute power off by MSCS first and disconnect AC power to save your configuration.



### 5.2. Start MSCS

- MSCS is an application program needed to control MLCD.
- When you execute MSCS (v 7.0) for your product at the installation screen, it will create a new folder at *C:/Program File/MSCS (v7.0)* and an icon on your computer screen.
- By double clicking the MSCS (v 7.0) icon, the initial screen image of MSCS (v 7.0) will be displayed as shown in the picture.



Main Image of MSCS (Multi Screen Control system)

### 5.3. Setting of COM Port

- Com Port connects or disconnects the communication between PC and MLCD.
- Connect MLCD to PC Com Port via RS-232C cable.

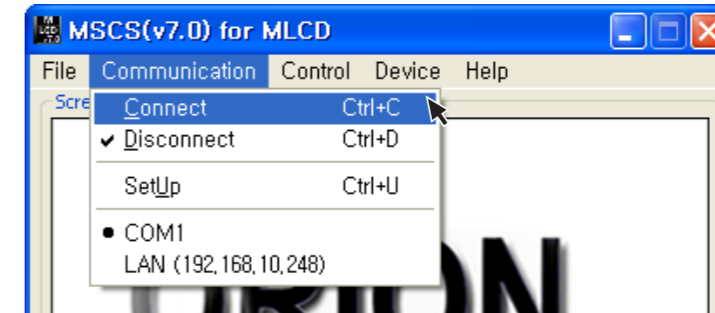

- Go to MSCS Menu -> Communication and set Com Port. Click 'Connect' using mouse or press 'Ctrl+C' using keyboard.
- In order to disconnect communication, click 'Disconnect' using mouse or press 'Ctrl+D' using keyboard.
- When you use USB-to-RS-232C converters, you need to set Com Port again, because MSCS uses one of Com Port no. 1 to 30.

※ Available Com Port on the PC is automatically recognized and displayed.

- Com Port Configuration

Baud Rate	115200bps(Fixed)
Data Bit	8Bits
Parity	None
Stop Bit	1Bit
Flow Control	None

### 5.4. Setting of LAN Port (In case of connecting to a LAN Hub)

- This function is used to control the MLCD via LAN PORT.
- \* During the setting process, MLCD and control PC should be connected via RS-232C cable only. Do not connect ethernet cable.
- \* After setting process, the control PC should be connected to one of MLCD sets with Ethernet cable only. For the connection between the MLCD sets, they should be connected with RS-232C cables.

#### ■ Network IP setting for MLCD

- 1) Execute the LAN Configurator V1.0 from installation CD.
- 2) Select Com Port and select "OPEN".

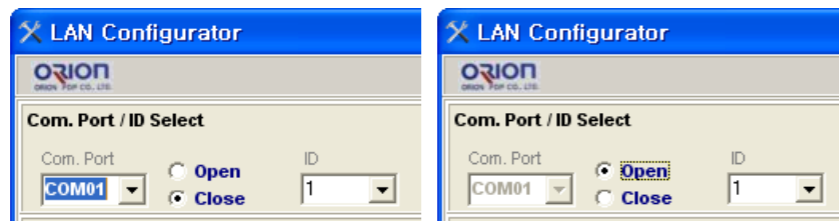

- 3) Select ID of MLCD which you want to control.
- 4) Turn off MLCD.

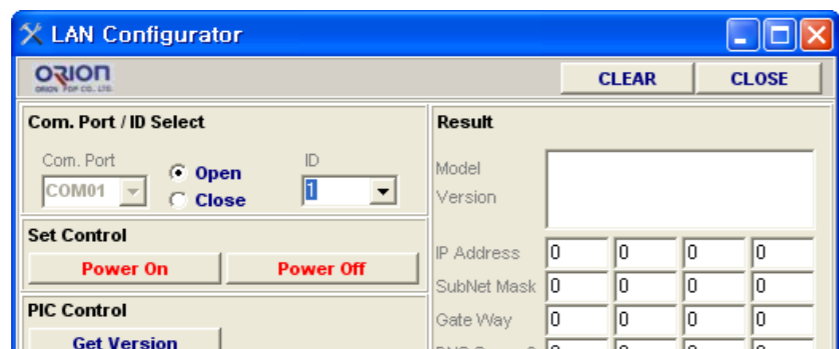
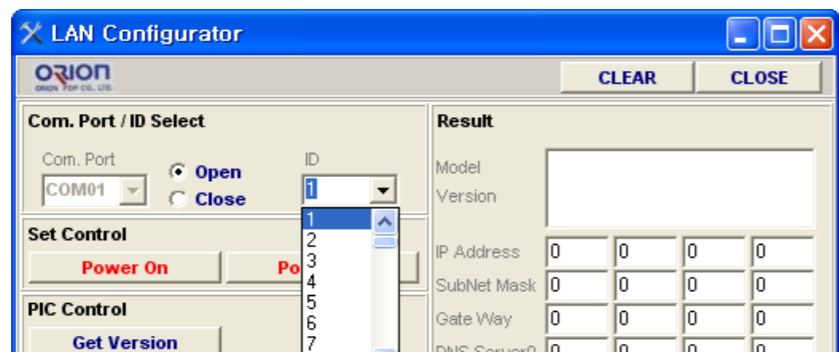

- 5) Type in IP Address.

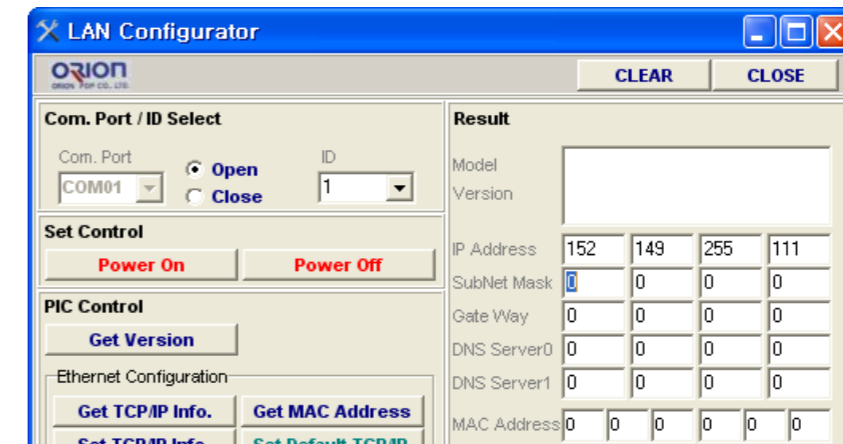

- 6) Click "SET TCP/IP Info".

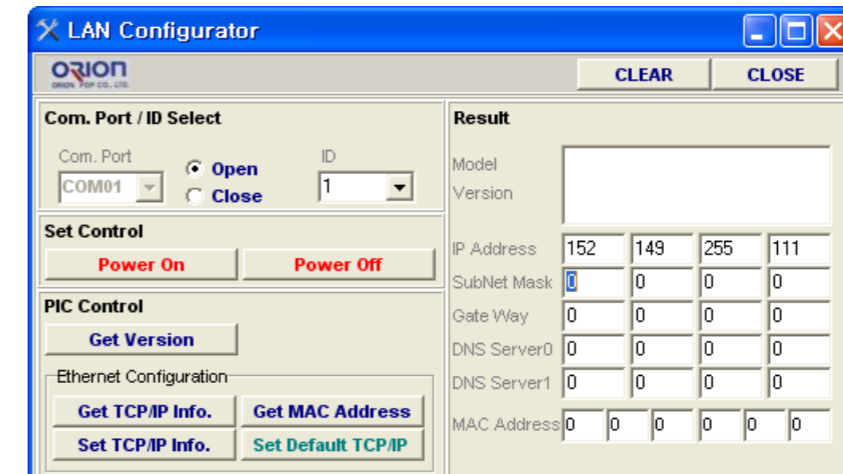

- 7) Click "GET TCP/IP Info." and Confirm the IP Address.

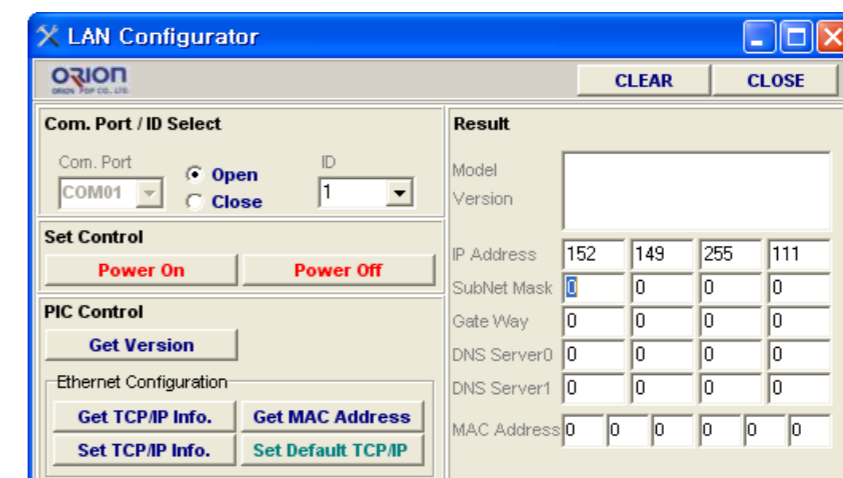

- 8) Close the LAN Configurator V1.0

### 5.5. Setting of LAN Port (In case of connecting directly to user's computer)

■ Check the network informations

- 1) Execute the LAN Configurator V1.0 from installation CD.
- 2) Select Com Port and select "OPEN".

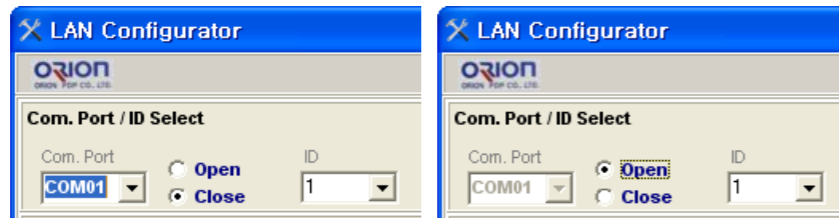

- 3) Select ID of MLCD which you want to control.
- 4) Turn off MLCD.

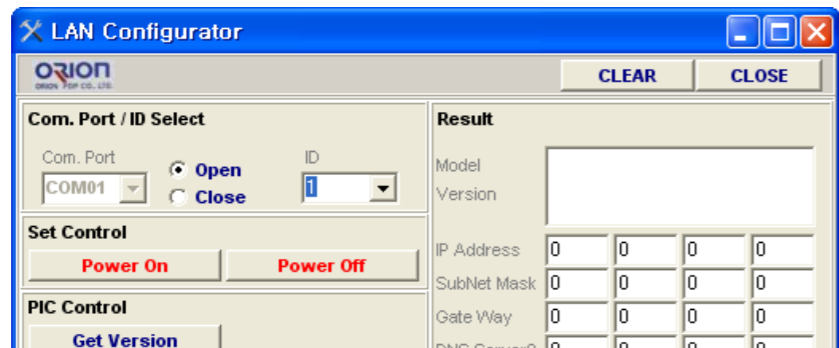
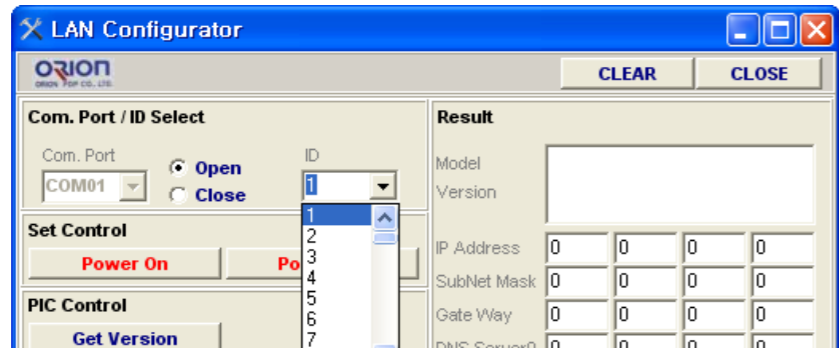

- 5) Click "GET TCP/IP Info." and check the network informations.

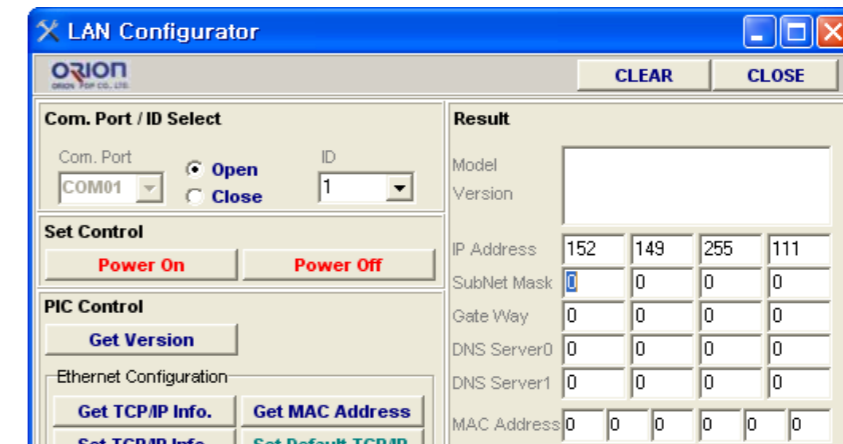

- 6) Input the network information of the user's PC to be identical with MLCD set. However, the final digit of the IP address must be different.

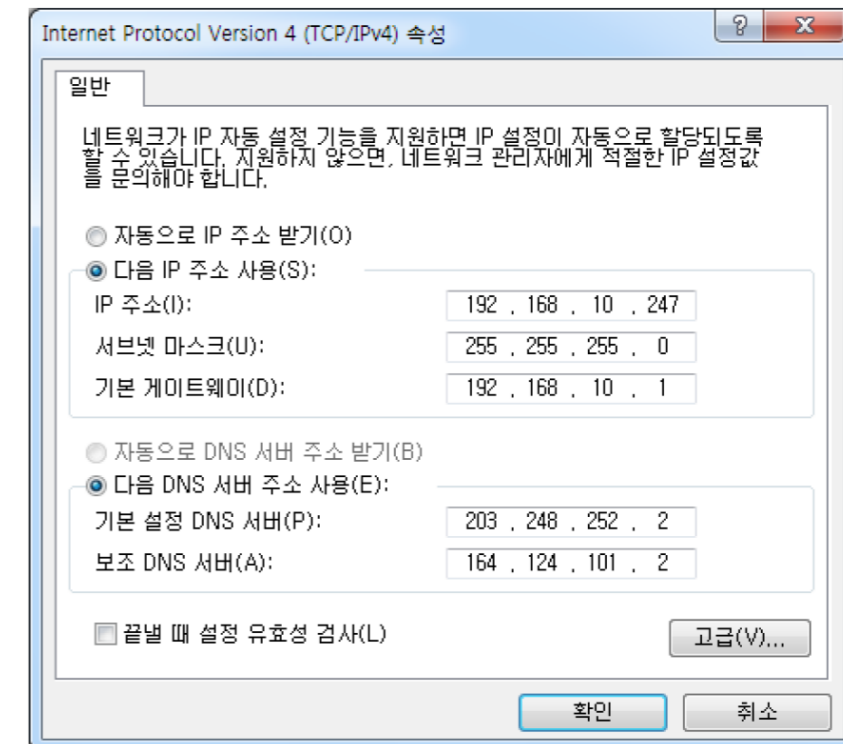

### 5.6. Network IP setting for MSCS

1. Execute the MSCS.
2. Select "Menu->Communication -> Setup" or "Ctrl+U" to start setup.

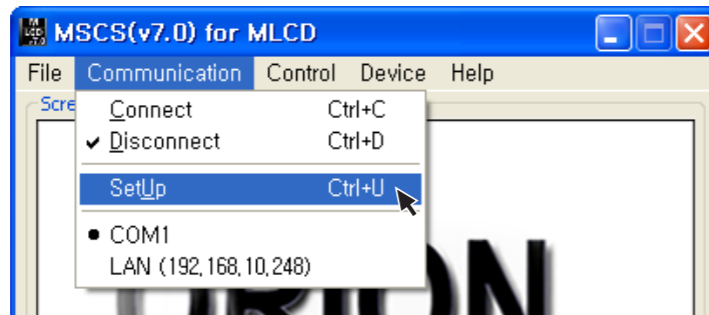

3. Select "Socket" radio button.
4. Type in IP Address of MLCD.
5. Click "Ping Test" to check status of communication.
6. Close the Communication setup window

#### • Menu Description

- **Serial** : Set the serial communication as a default communication.
- **Com Port** : Set the port of a PC to communicate with MLCD.
- **Baud Rate** : Fixed at 115200bps.  
 ※ **Caution: Users cannot change the Baud rate.**
- **Socket** : Set the Ethernet LAN communication.
- **Edit Box** : Set the IP address.
- **Port Number** : Fixed as 9761.  
 ※ **Caution: Users cannot change the port number.**
- **Ping Test**: Test the IP address.
- **Connect** : Connect the communication.

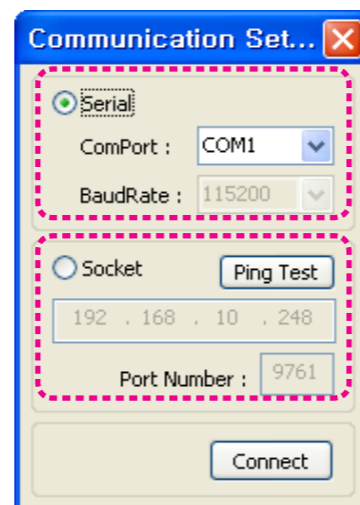

Communication Setup

### 5.7. "New design/Last design" setting

- You can see following pop-up window for "New design/Last design" when you click "Connect" or press "Ctrl+C" using keyboard after select communication type.



New/Last Design Set

- Click "Open New Design" to prepare new configuration.
- Click "Open Last Design" to go to last design before closing.
- When the connection is successfully completed after setting Com Port, following Message dialog is displayed. The dialog window will be disappeared in 1 second.

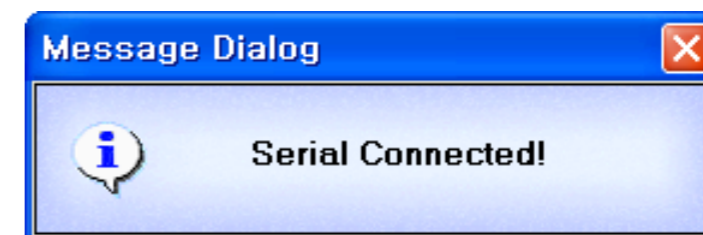

- When the connection is successfully completed after setting Lan Port, following Message dialog is displayed. The dialog window will be disappeared in 1 second.



### 5.8. Multi-screen configuration

1. Input the numbers of X and Y
  - X is for the number of row and Y is for column.
  - X and Y can be selected within the range from 1 to 15. The maximum MLCD quantity of MSCS control is 100 sets.
  - MLCD image of selected numbers of X and Y is displayed in the Screen configuration in one second after setting the number.

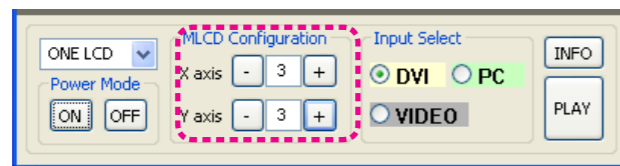

Screen Configuration Setting

2. Select one of input sources from DVI, PC or Video
3. Execution of the configuration.
  - When you click "PLAY" button after selecting input source from Source select and the numbers of X and Y in MLCD Configuration, the configuration of MLCD is generated as shown in the figure below.

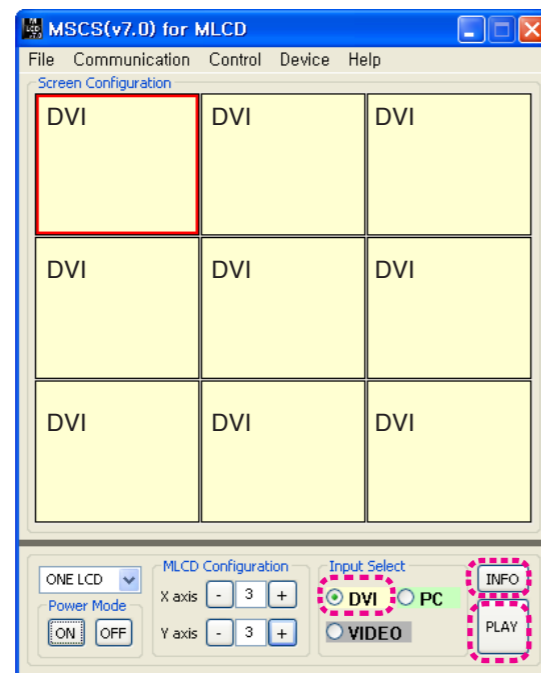

- ※ **INFO :**
- Check the resolution of the input source. It is displayed at the upper right corner of the screen.
  - Check the signal. If there is no input signal, "No signal" is displayed.

### 5.9. Selecting the command transmission method

- **ONE LCD** : Transmit Protocol Command to one MLCD.
- **ALL LCD** : Transmit the Protocol command sequentially to all connected MLCD sets.
- **Broadcast** : Transmit the Protocol command simultaneously to all connected MLCD sets.
- In order to control power of specific MLCD, use "Power On/Off" button after selecting the specific MLCD.

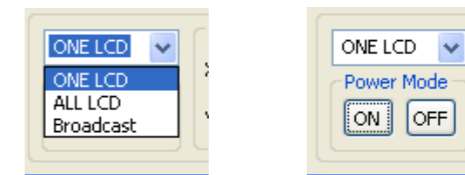

MLCD Control - Power On/Off



- Please wait for at least 10 seconds before executing "Power On" command after the first AC power connection. If not, it may cause abnormal behavior.
- Please disconnect AC power and reconnect in case of abnormal behavior.

### 5.10. Changing the input source

- Varieties of screen formations are available with screen configuration.
- Select DVI, PC or Video at the Input Select menu.

1) If you select DVI and click Play button at the Input Select menu, the input source will be changed from PC to DVI .

- In case you do not select a screen and click Play, the input source for the all screen will be changed.

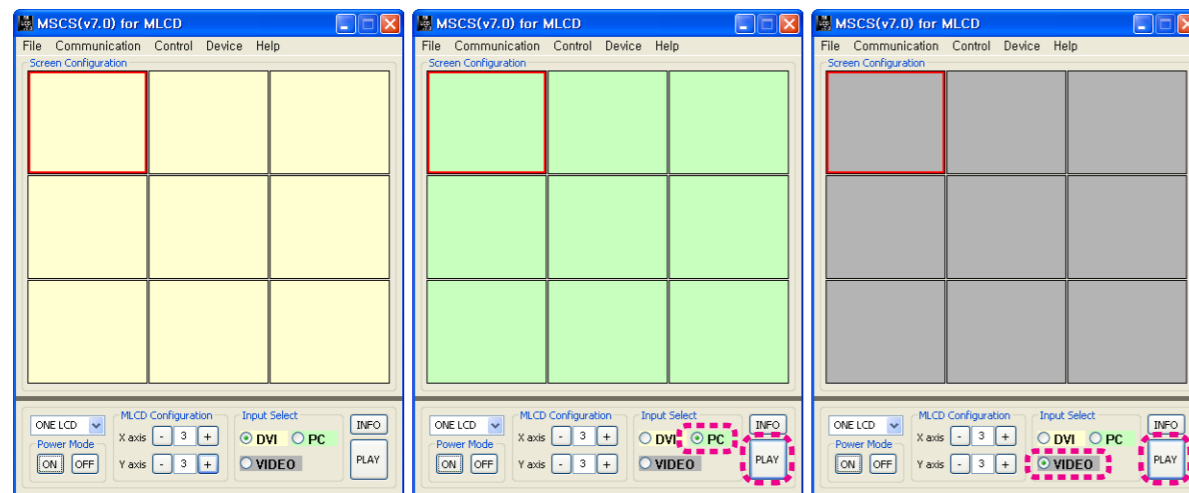

Select DVI at the Input Select menu

※Input source is not displayed on the MSCS screen, but it is indicated by colors.  
(DVI : Yellow PC : Green Video : Gray)

### 2) Screen formation

- To make various Input-screen formation, select an input source and click the screen you want in the Screen configuration with the left button of the mouse.

1. Select PC at the Input Select menu.

- e.g.) in case PC is selected

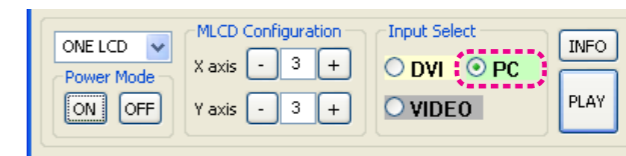

2. Click the screen you want in the Screen configuration with the left button of the mouse.

- Click the screen you want in the Screen configuration with the left button of the mouse.
- DVI screen will be changed with PC.

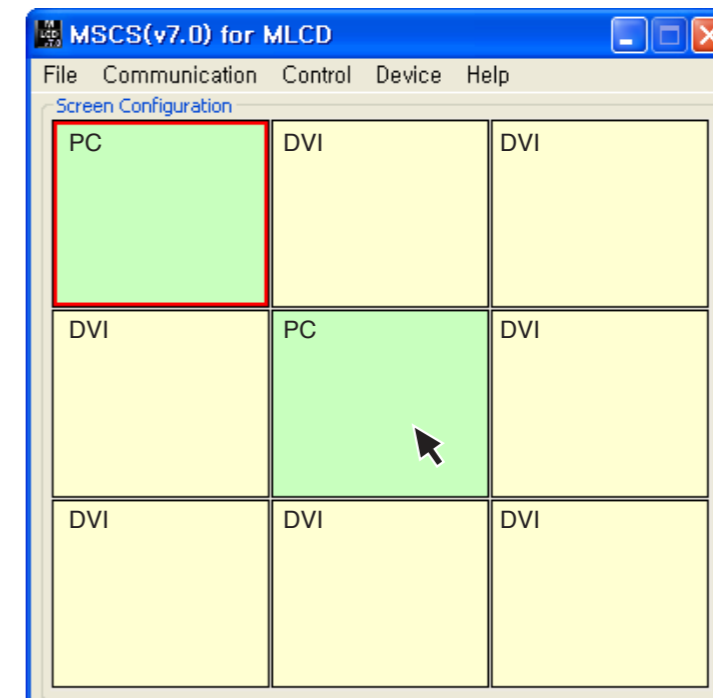

**3) Screen Formation with one step.**

- You can make various multi-screen formations with simple movement.

**1. Select an input source at Source Select menu.**

- e.g.) In case you want to select PC

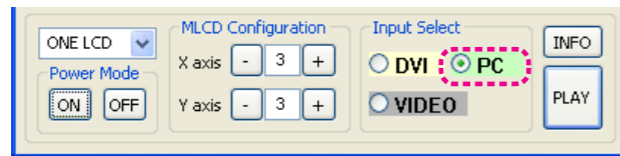

**2. Click the screen you want in the Screen Configuration with the left button of the mouse and drag.**

- Click the screen you want in the Screen Configuration with the left button of the mouse and drag to the screen you want to include.
- When you stop dragging, selected screens will be changed to PC automatically.

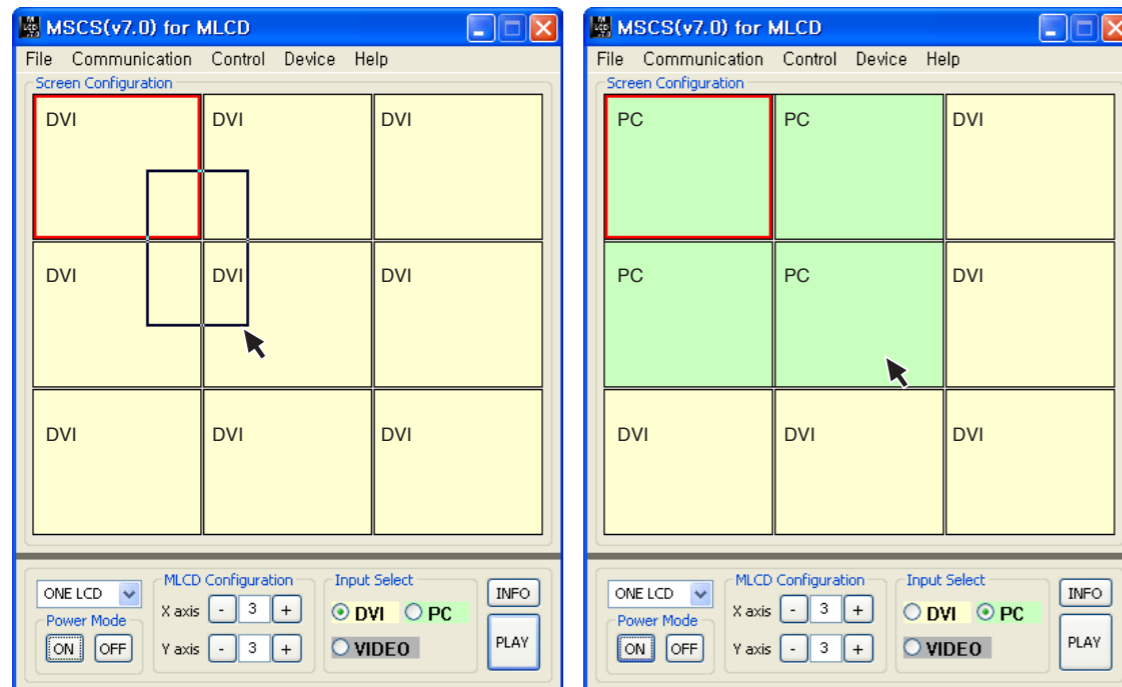

**5.11. Slide Control**

- MLCD configuration that users can choose is displayed repeatedly.
- To use Slide Control, go to MSCS Menu -> Control -> Slide Control or press "Ctrl+S" using Keyboard.

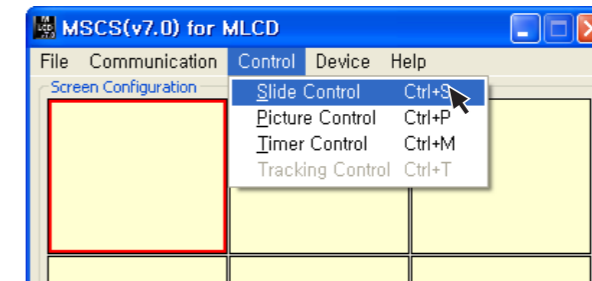

**1. Make a desirable configuration in "Screen Configurations"**

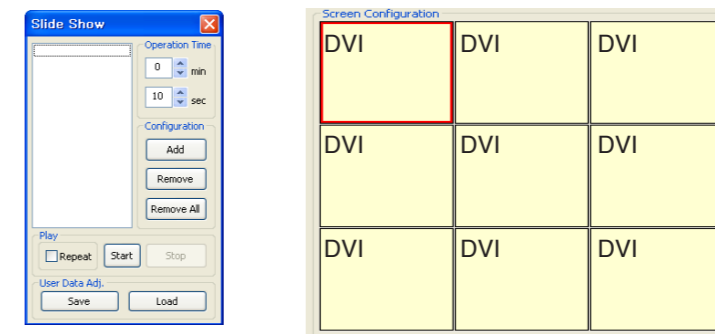

**2. Set "Operation Time" in "Slide Control"**

- Click "Add" button to save configuration.
- The range of "Operation Time" is from 10 seconds to 1 hour.

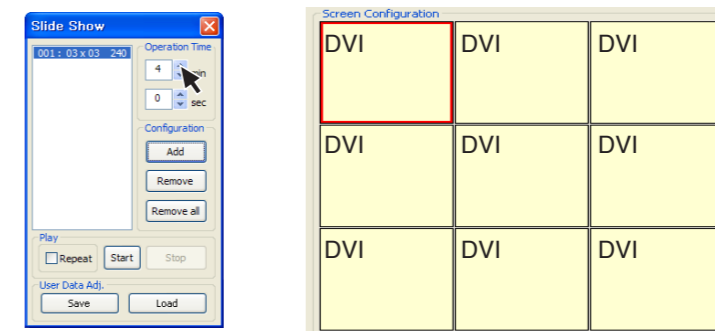

3. Save various screen configurations in the same way.

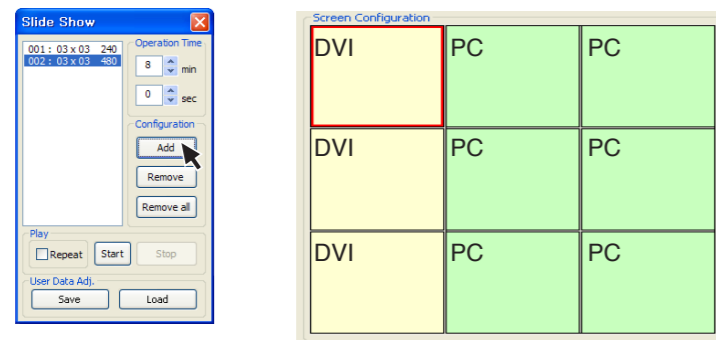

4. Click "Slide Start" to display saved screen configurations.

- Saved screen configurations are displaying for preset time.

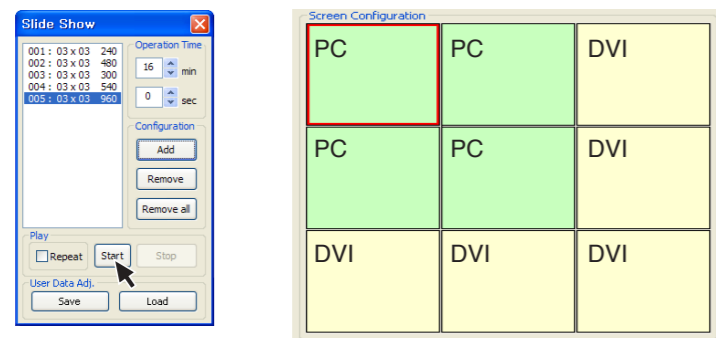

5. Check "Repeat" to display saved configuration repeatedly.

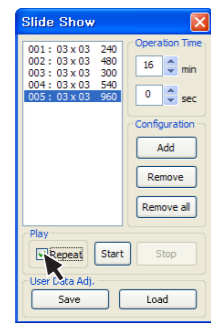

6. Click "Stop" button to end "Slide Control"

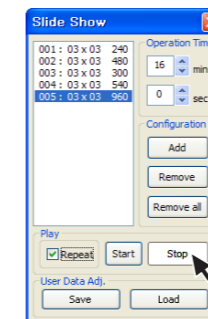

7. Save or Load the slide configuration

- Click "SAVE" button to save user added Slide configuration as "\*.ssd" file.
- Click "LOAD" button to open saved "\*.ssd" file.

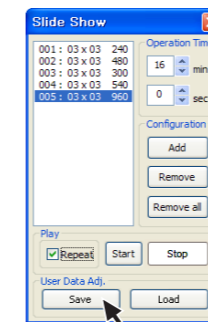

**Caution** ⚠

- When you load "Slide File", previous slide configuration and new slide configuration must be identical.
- If they are different, the file cannot be loaded. So, revise the new slide file configuration as previous configuration or save as new file.

※ To view the saved screen configuration, select the list from "List Box."

※ Saved screen protocol is transmitted to MLCD by double clicking the list.



### 5.12. Picture Control

- Register values related to display of MLCD can be changed.
- To use Picture Control, go to MSCS Menu -> Control -> Picture Control or press "Ctrl+P" using Keyboard.

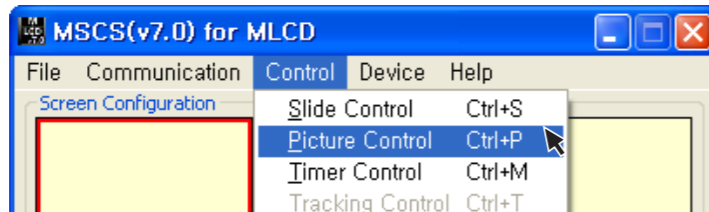

- In order to control display values, input values directly in "Edit Box" and press Enter key. Or click +/- button using mouse.
- Click "Exit" button or press "Ctrl+X" using keyboard to close "Picture Control" window.

- **Color Temp** : Change the color temperature of the screen
  - Normal : Initial setting. Proper for normal video image view.
  - Studio : Low Color temperature. Proper for broadcasting purpose.
- **Brightness** : The range of "Brightness" you can adjust is 0 to 100.
- **Contrast** : The range of "Contrast" you can adjust is 0 to 100.
- **Sharpness** : The range of "Sharpness" you can adjust is 0 to 28.
- **Dimmng** : The range of "Dimming" you can adjust is 0 to 100
- **User Data** : Users can adjust color impression with white screen and save or load the adjusted value.
  - Save - Save User's data file (\*.pdt)
  - Load - Load User's data file (\*.pdt)

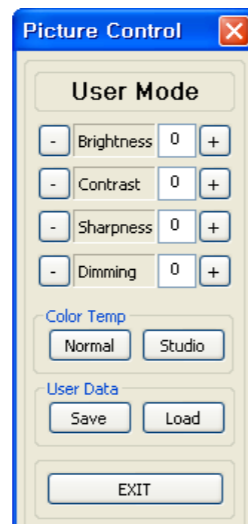

### 5.13. Timer Control

- Users can decide the time of turning on or off MLCD set by timer control.
- To use this function, click Menu -> Control-> Timer Control or use 'Ctrl +M' keys from the keyboard.

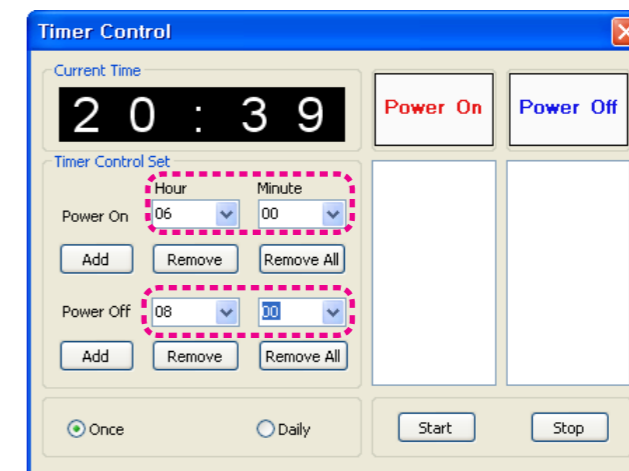
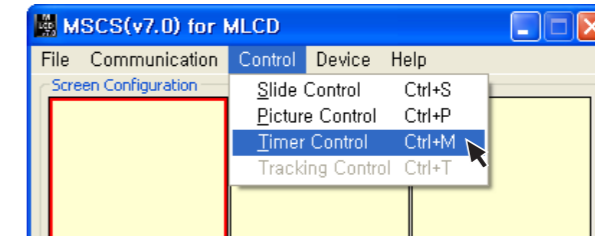

Timer Control Dialog

- How to set the time of power on or off.
  - a) Select Hour and Minutes of turn on or off
  - b) After setting Power On/Off time, click "Add" button to add it to Power On/Off List Box. You can save up to 10 settings for Power On/Off. Also, you can delete the saved settings in the List Box one by one with "Remove" button. If you delete all the settings, click "Remove All" button.
  - c) Select once for one time use and Daily for daily use, then click 'Start'
  - d) Power on or off signal will be transmitted to MLCD at the time of user set.
- Time Dialog must be activated to use Timer function

### 5.14. Tracking Control

- Alignment adjustment is available when input source is PC.

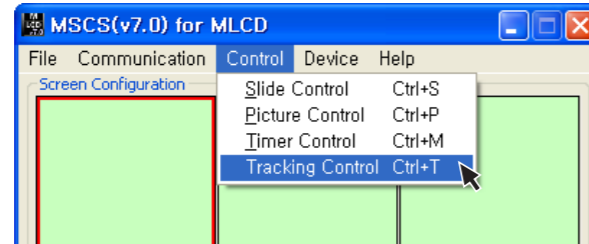

- Go to "Control" in menu bar -> Tracking Control or press "Ctrl+T" using keyboard to run "Tracking" window.
- Press "Tracking Auto" button in order to run auto tracking.
- In case alignment doesn't work through "Tracking Auto" command, user can tune finely through "Manual".
- Manual Tracking enables users to set Frequency, Phase, LineStart and PixelStart.
- Select panel ID which you want to adjust alignment.

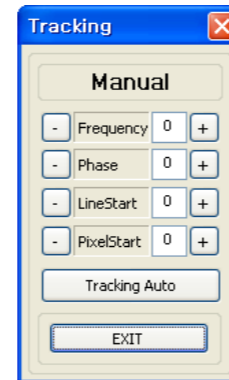

Tracking Manual Window

- Detail adjustment steps are as follows.
  - 1) Tune "Phase" until the vertical lines are clearly adjusted..
  - 2) Tune "LineStart" to adjust vertical alignment. "PixelStart" for horizontal alignment.
  - 3) Adjust "Frequency" if alignment is still wrong. If you adjust "Frequency", repeat step 1) and 2) to fit alignment. Adjustable range is as follows
    - The range of "Frequency" you can adjust is -50 to 50
    - The range of "Phase" you can adjust is 0 to 63
    - The range of "Linestart" you can adjust is -23 to 10
    - The range of "Pixelstart" you can adjust is -50 to 40
- Click "EXIT" button or press "Ctrl+X" using keyboard to close "Tracking" window.
  - ※ When "Tracking" windows is on display, users cannot display "Picture Control" window.
  - ※ Even when "Tracking" window is on display, selecting panel ID is available by clicking right button of mouse.

### 5.15. ORION Homepage log on and Version Information

- In order to move to Orion website, go to "Help" of menu bar ->"OrionDisplay HomePage".

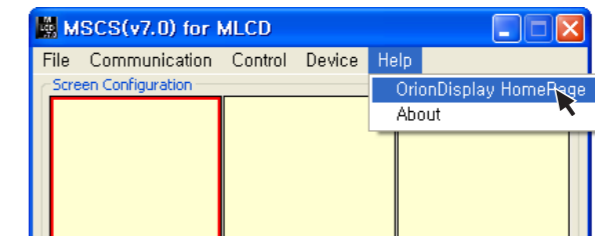

ORION Homepage Log on

- Go to "Help" of menu bar -> "About" to check MSCS.

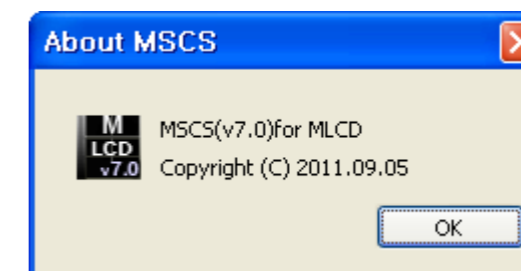
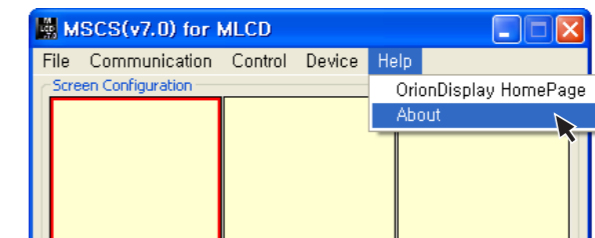

Checking MSCS Version

## 6. Control Method of optional accessory

### 6.1. New MFC

#### 1) New MFC Connection

1. Connect power.
2. Connect female D-sub to the Com port in a computer.
3. Connect male D-sub to the RS-232C port in MLCD.
4. Install the MFC connected with RS-232C cable and a power adapter at the location of good Remote controller reception.
5. Set the number of the connected MLCD units in advance. The number can be set only by the Remote controller.

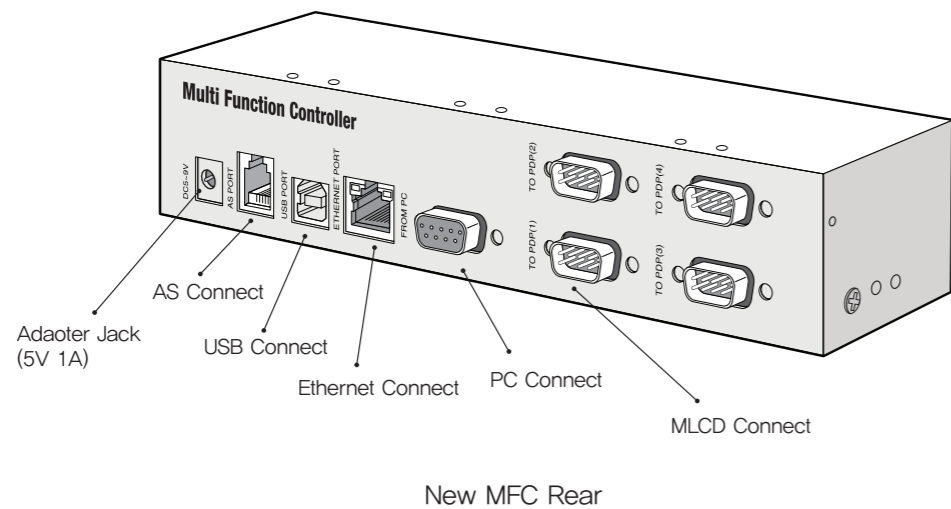
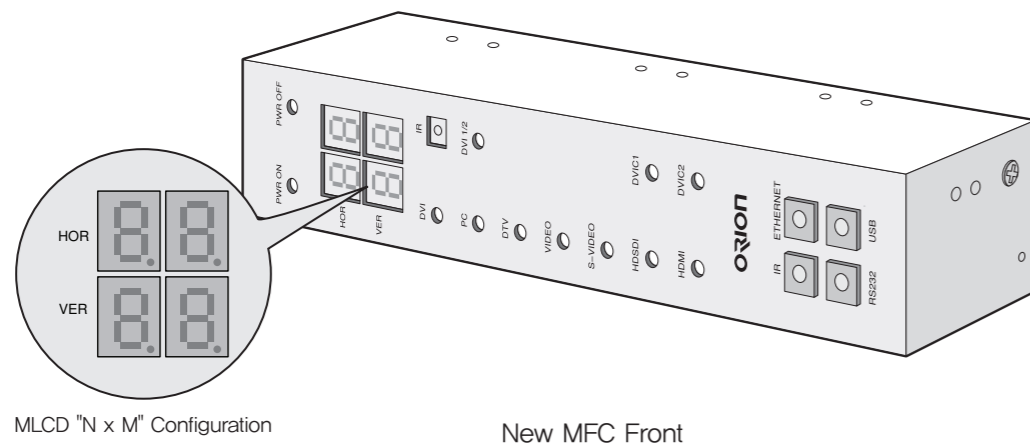

#### 2) MLCD Set Configuration (e.g. X:5 sets x Y:6 sets)

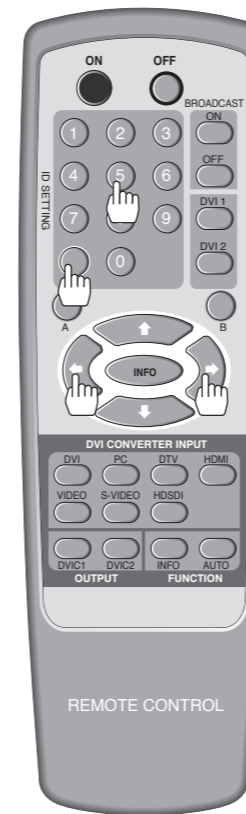

#### Horizontal configuration

1. Press SET button .



2. Press Left and Right buttons sequentially to enter the horizontal configuration mode.

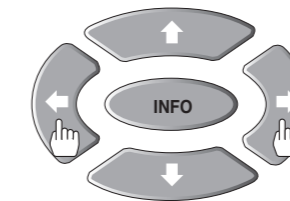

3. When the 2 LEDs at lower right corner of each 7-segment of lower line in the New MFC are turned on, the horizontal configuration mode is started.

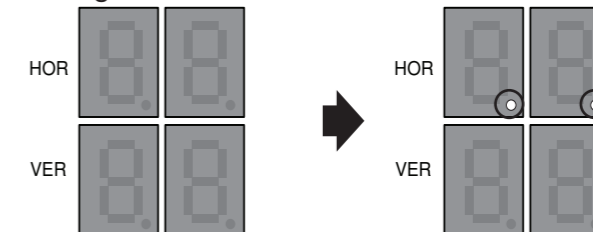

4. Use the number buttons to set the numbers of MLCD sets in horizontal line.

- e.g. If you want to set 5 for horizontal number, press "0" for ten's place and "5" for one's place.

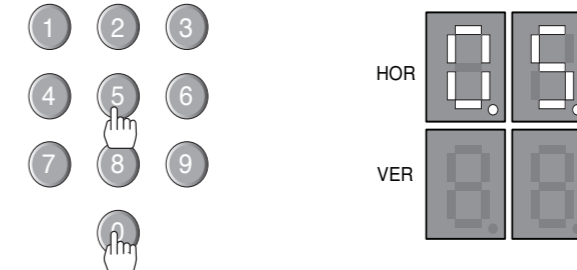

5. Press SET button to finish the horizontal configuration mode.





**Vertical configuration**

1. Press SET button.



2. Press Up and Down buttons sequentially to enter the vertical configuration mode.

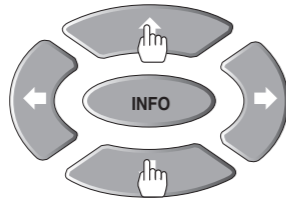

3. When the 2 LEDs at lower right corner of each 7-segment of lower line in the New MFC are turned on, the vertical configuration mode is started.

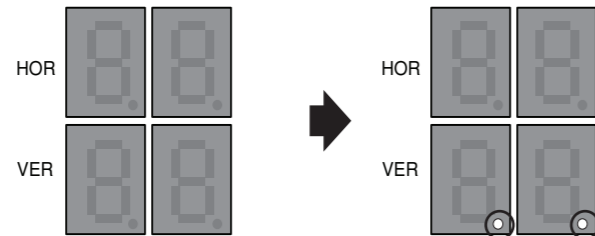

4. Use the number buttons to set the numbers of MLCD sets in horizontal line.

- e.g. If you want to set 6 for vertical number, press "0" for ten's place and "6" for one's place.

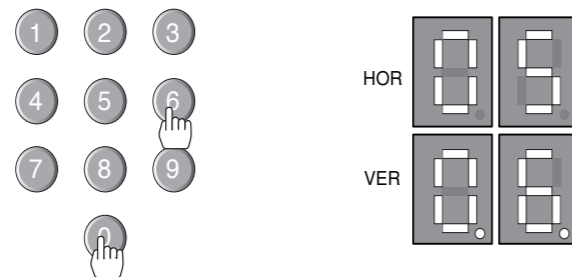

5. Press SET button to finish the vertical configuration mode.



**6.2. DVI Converter**

- To use DVI Converter, go to MSCS Menu Device DVI Converter or press "Ctrl+V" using Keyboard.

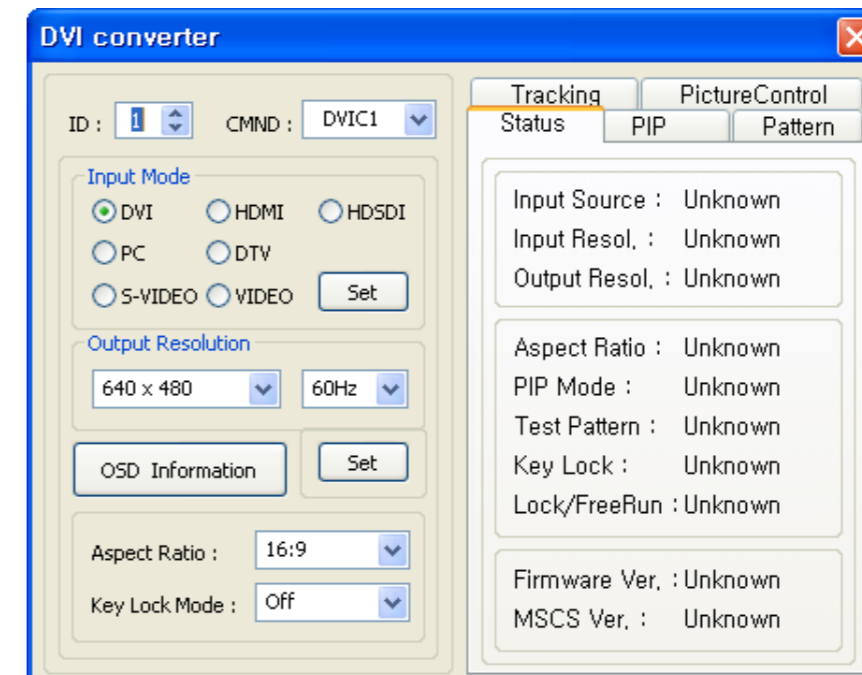
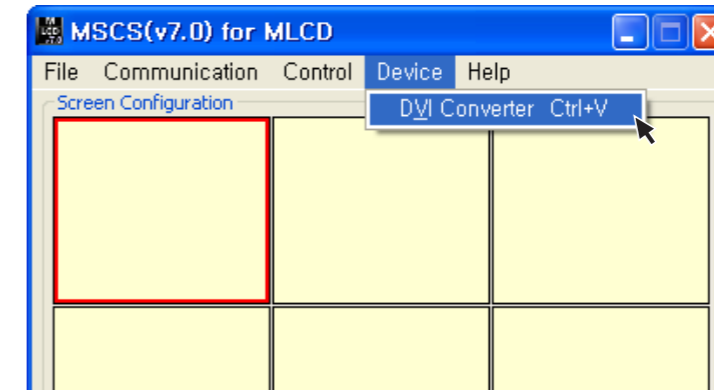

DVI Converter Dialog

### 1) ID

- Set the ID of DVI Converter. The ID can be selected from 1 to 9.

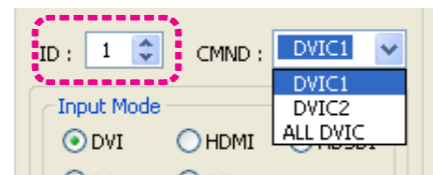

### 2) CMND

- Select the channel of DVI converter to control.
- One of DVI Channel 1(DVIC1), DVI Channel 2(DVIC2), and ALL DVI Channel can be selected.

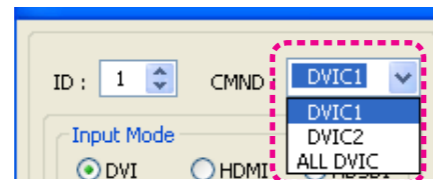

### 3) Input Mode

- Select the input mode of DVI Converter.
- One of DVI, HDMI, HDSDI, PC, DTV, S-VIDEO, and VIDEO can be selected.
- **Set** : Select one mode from 7 Input Modes and execute.

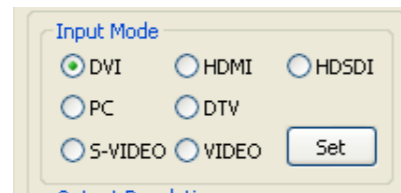

### 4) Output Resolution

- Set the output resolution of DVI Converter.

Resolution	frequency
640 x 480	60Hz / 85Hz
800 x 600	50Hz / 60Hz / 85Hz
853 x 480	50Hz / 60Hz
1024 x 768	60Hz / 85Hz
1280 x 1024	50Hz / 60Hz
1600 x 900	50Hz / 60Hz
1600 x 1200	50Hz / 60Hz
1706 x 960	60Hz
1920 x 1080p	50Hz / 60Hz

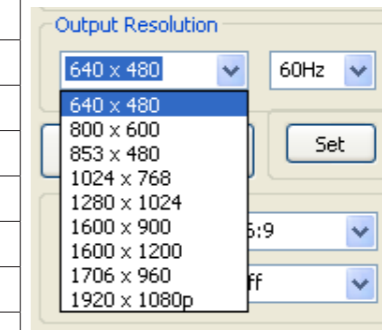

- **Set** : Set the output resolution.

### 5) OSD Information

- The DVI converter input and input resolution are displayed on the screen.

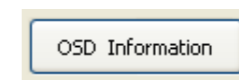

### 6) Aspect Ratio

- Set or change the screen ratio (Horizontal: Vertical)
- **16 : 9** : Set the screen ratio as 16:9 wide screen.
- **4 : 3** : Set the screen ratio as 4:3
- **LB(Letter Box)** : Expand the screen image to remove the black patterns at the top and bottom portions of the screen.
- **LBS(Letter Box Subtitle)** : Expand the screen with the subtitle to the top portion. (The bottom portion remains with black pattern)

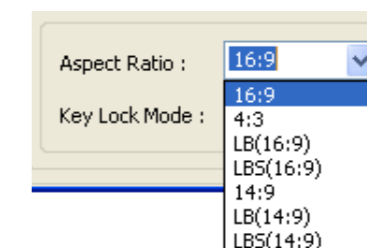

**7) Key Lock Mode**

- Lock the front key of DVI Converter not to turn On or Off.

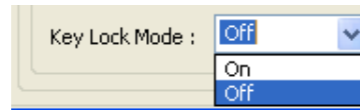

**8) Status**

- Display the DVI Converter status (Input Source, Input Resolution, Output Resolution, Aspect Ratio, PIP Mode, Test Pattern, Key Lock, FreeRun/Lock, Firmware Version, MSCS Version information)

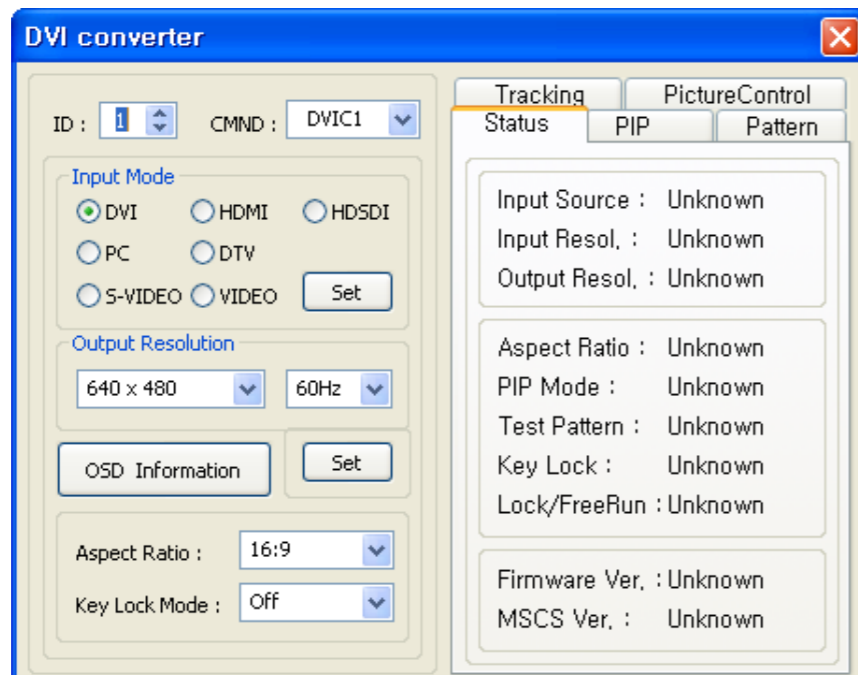

**9) Picture Control**

- Control the Brightness, Contrast, Sharpness, Color, and Tint of the DVI Converter.
- **Brightness** : The range of "Brightness" you can adjust is 0 to 100.
- **Contrast** : The range of "Contrast" you can adjust is 0 to 100.
- **Sharpness** : The range of "Sharpness" you can adjust is 0 to 28.
- **Color** : The range of "Color" you can adjust is 0 to 100.
- **Tint** : The range of "Tint" you can adjust is 0 to 90.
- **Firmware Default** : Initialize the adjusted values to the default values.

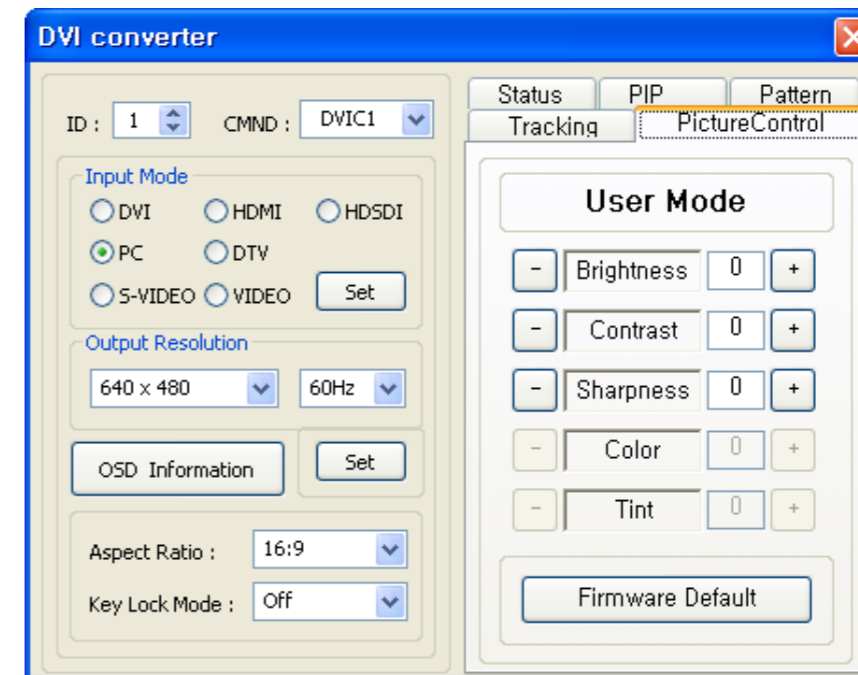

### 10) Pattern

- Select the Test Pattern (Red, Blue, 8-Color, 16-Gray, Green, White, White (10%), Screen)
- **Set** : Set or change the Pattern.

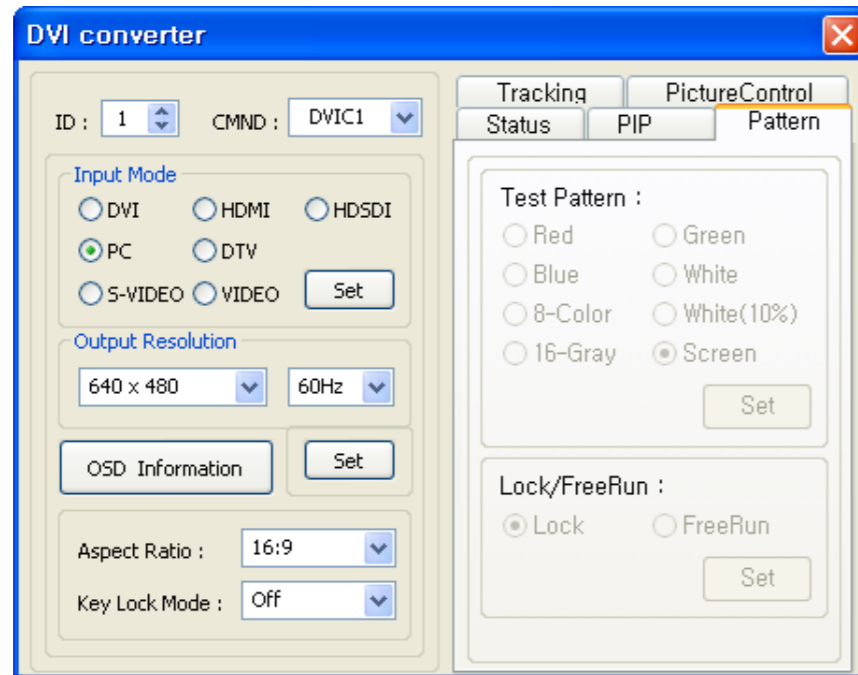

### 11) Lock/FreeRun

- **Lock** : Default setting. It is used when MLCD is configured as the default display. If the vertical frequency of input signal and out signal is identical, output is generated according to vertical synchronization.
- **FreeRun** : This function is used when the default display is not MLCD and screen image is not displayed. It generates its own output vertical frequency regardless of input signal. If screen image is displayed, use Lock mode.
- Lock/FreeRun can be configured by the keypad of DVI converter besides MSCS. While Menu OSD is not displayed, FreeRun mode can be selected by pressing UP key and Lock mode by DOWN key.

### 12) Tracking

- Control the Screen size, sharpness, and position of DVI Converter with PC input mode.
- In case alignment doesn't work through "Tracking Auto" command, users can tune finely through "Manual Tracking".
- "Manual Tracking" window enables users to set Frequency, Phase, LineStart and PixelStart.
- Detail adjustment steps are as follows.
  - 1) Tune "Phase" until the vertical lines are clearly adjusted..
  - 2) Tune "LineStart" to adjust vertical alignment. "PixelStart" for horizontal alignment.
  - 3) Adjust "Frequency" if alignment is still wrong. If you adjust "Frequency", repeat step 1) and 2) to fit alignment. Adjustable range is as follows
- **Frequency** : The range of "Frequency" you can adjust is -50 to 50
- **Phase** : The range of "Phase" you can adjust is 0 to 63
- **Linestart** : The range of "Linestart" you can adjust is -23 to 10
- **Pixelstart** : The range of "Pixelstart" you can adjust is -50 to 40
- **Auto Tracking** : Automatic alignment for DVI Converter screens.
- **Auto Calibration** : Automatic color control for DVI Converter screen.

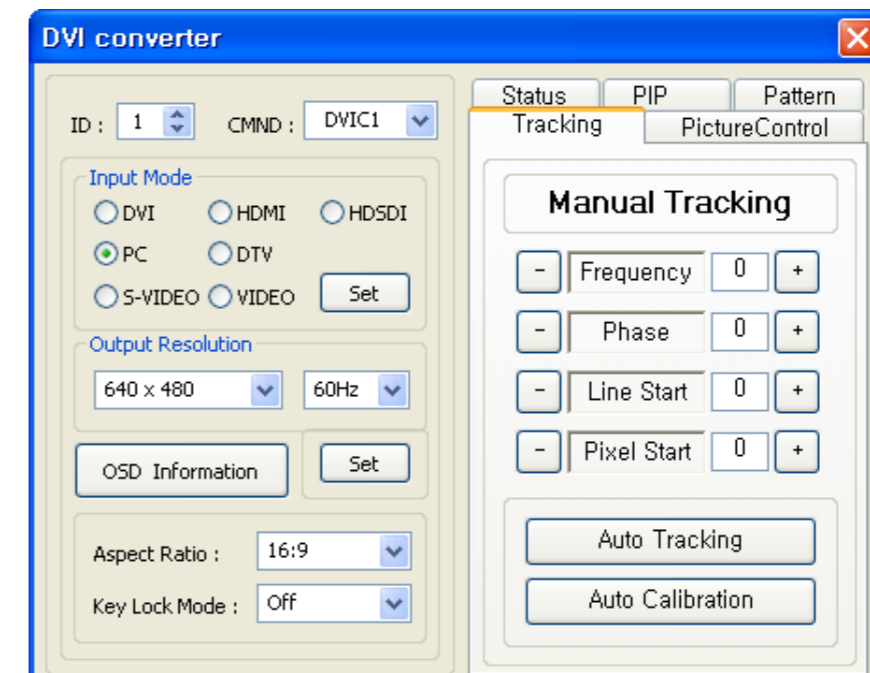

### 13) PIP (Picture In Picture)

- A variety of images can be displayed with the PIP function of DVI converter. To activate PIP, click "PIP" in the Mode. The position of sub-picture can be controlled by clicking - / + buttons increase or decrease the number or directly type in the numbers at Edit box.
  - Various input sources can be used. To set the sub-input, click the sub-input combo box and select sub-input.
  - Main screen and sub-screen can be swapped with the PIP Swap function. Press "Set" button at the right side of "PIP Swap." If you want to return to previous screen, press "Normal" button at the right side of "PIP Swap."
  - **Mode** : Normal mode - Normal screen without PIP (PIP Off)  
PIP mode-Sub-screen is displayed at the lower right corner of the screen. (PIP On)
  - **Position** : Horizontal - Adjust the horizontal location of PIP. Adjustable range 0~100  
Vertical - Adjust the vertical location of PIP. Adjustable range 0~100
  - **Sub Input** : Set the input for PIP. One of DVI, HDMI, HDSDI, PC, DTV, S-VIDEO, and VIDEO can be selected for sub-input.
- ※ According to the main input, the sub-input can be restricted. If the main input is a digital input such as DVI, HDMI or HD-SDI, the sub-input should be an analog input such as PC, DTV, S-VIDEO or Video. If the main input is an analog input the sub-input should be a digital input.
- **PIP Swap** :OFF - Return to previous locations of swapped Main Source Input screen and Sub Source Input screen.  
ON - Exchange the locations of Main Source Input screen and Sub Source Input screen.

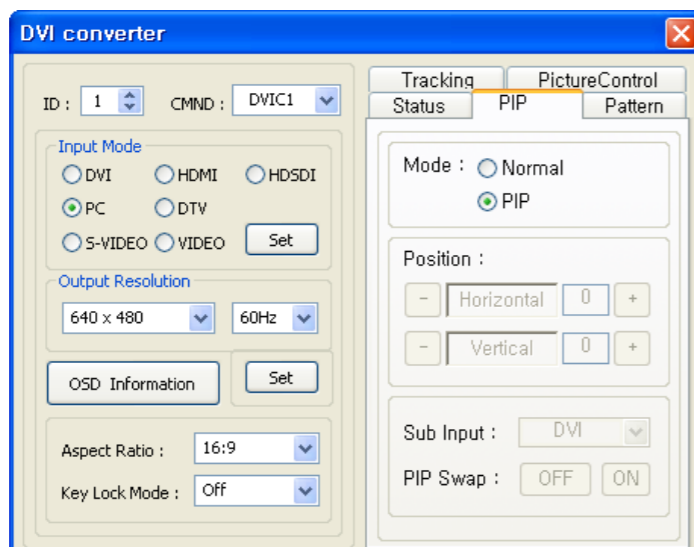

## 7. MSCS Protocol

### 1. Introduction

This chapter contains the communication protocol between LCD and its control devices such as computer for better use of the product. However, it does not include detailed technical matters. It rather focuses on the brief functional explanation and communication protocol.

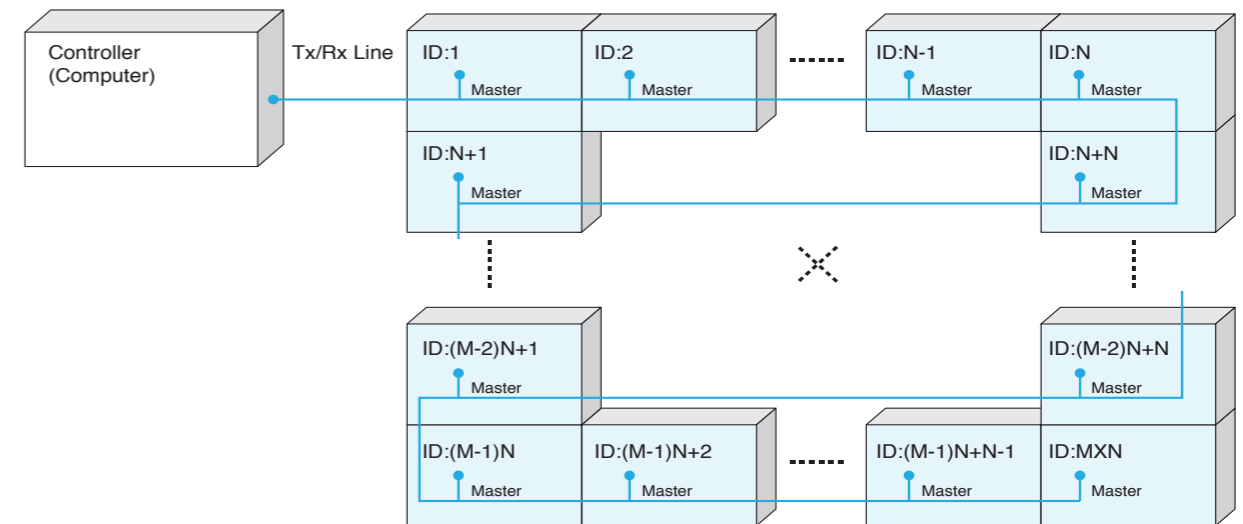

※ The connection can be variable based on environment or the users' intention.  
< Communication connection diagram >

#### 1.1. Communication Setting

Transmission & Reception type	Connection type	Baudrate	Data Bits	Parity	Stop Bits	Flow Control
Asynchronous Serial Communication	Daisy Chain	115200	8	None	1	None

## 2. Protocol Format

### 2.1. Send To LCD

STX	Command	Length	Data	ETX
1 byte	1 byte	1 byte	Variable	1 byte

ID	Master	Other Data
1 byte	1 byte	N byte

- This is how to send commands to LCD. Only the set of the designated ID is working according to the "Command." But, if the "ID" value is "0", all MLCD sets are working according to command as "Broadcast".
- STX(0x02): The initial code. It means the beginning of Protocol. (Fixed value)
- Command: Code for actual operation. (Variable)
- Length: the length of "Data" area. (Variable: 0~255)
- Data: the areas for "ID" and the other Data (Variable)
- ID: It is a code to distinguish LCD sets. Its range is "0" to "255". If the ID is "0," it means Broadcast command.(variable)
- Master(0x01) : This is the scaler code.
- ETX(0x03): The end of the code. (Fixed value)



### 2.2. Receive From LCD

STX	CMD	Length	Data	Check Sum	ETX
1 byte	1 byte	1 byte	Variable	1 byte	1 byte

ID	Master	Other Data
1 byte	1 byte	N byte

- Response by a certain command from the designated set among MLCD sets. The difference from "Send to LCD" is "Check sum".
  - STX(0x02): The initial code. It means the beginning of Protocol. (Fixed value)
  - Command: Code for actual operation. (Variable)
  - Length: the length of "Data" area. (Variable: 0~255)
  - Data: the areas for "ID" and the other Data (Variable)
  - ID: Set identification (0~255) (Variable)
  - Master(0x01) : This is the scaler code.
  - Check sum: execute "Not" operation after adding all the values in "STX~Data" area.
  - ETX(0x03): The end of the code. (Fixed value)
- Communication Sequence
- \* Wait for 50msec for response after sending the command. If there is no response, it is recommended to resend the command.
  - \* It is recommended that not sending the other command or changing input resolution during command transmission.



## 3. Command

### 3.1. Power On

- Command for Power On: Operative status
- It is available only during Power Off(Stand-by) status.
- CMD: 0x40
- Send to MLCD

A. Normal command

Value	STX	CMD	Length	Data		ETX
				ID	Master	
	0x02	0x40	0x02	Variable	0x01	0x03

\* ID range(Program): 0x01(1) ~ 0xFF(255)

B. Broadcast command

Value	STX	CMD	Length	Data: ID	ETX
	0x02	0x40	0x01	0x00	0x03

\* Make all LCD do the same operation. But, there will be no return communication. (One way command)

- Receive from MLCD

Value	STX	CMD	Length	Data		Check Sum	ETX
				ID	Master		
	0x02	0x40	0x02	Variable	0x01	Variable	0x03

\* ID range (Program): 0x01(1) ~ 0xFF(255)

\* Check sum: execute "Not" operation after adding all the values in "STX~Data" area.

### 3.2. Power Off

- Command for Power Off : Stand-by status
- It is available only during Power On (Operative) status.
- CMD: 0x41
- Send to MLCD

A. Normal command

Value	STX	CMD	Length	Data		ETX
				ID	Master	
	0x02	0x41	0x02	Variable	0x01	0x03

\* ID range(Program): 0x01(1) ~ 0xFF(255)

B. Broadcast command

Value	STX	CMD	Length	Data: ID	ETX
	0x02	0x41	0x01	0x00	0x03

\* All LCD will do the same operation simultaneously. But, there will be no return communication. (One way command)

- Receive from MLCD

Value	STX	CMD	Length	Data		Check Sum	ETX
				ID	Master		
	0x02	0x41	0x02	Variable	0x01	Variable	0x03

\* ID range (Program): 0x01(1) ~ 0xFF(255)

\* Check sum: execute "Not" operation after adding all the values in "STX~Data" area.

### 3.3. Multi-Scale

- Command for expanding the screen of MLCD.
- It is available only on Power On (Operative) status.
- CMD: 0XDD (DVI), 0XDE(PC), 0XE2(VIDEO)
- Send to MLCD

A. Normal command

Value	STX	CMD	Length	Data				ETX
				ID	Master	XY	P	
	0x02	Variable	0x04	Variable	0x01	Variable	Variable	0x03

\* ID range (Program): 0x01(1) ~ 0xFF(255)

\* XY: The number of horizontal axis (X)/ the number of vertical axis(Y); upper 4 bits -X (Max: 15), Lower 4bits - Y (Max: 15)

\* P: the location of expanded screen

B. Broadcast command

Value	STX	CMD	Length	Data				ETX
				ID	XY	S	X	
	0x02	Variable	0x04	0x00	Variable	Variable	Variable	0x03

\* ID: 0x00

\* XY: The number of MLCD sets in horizontal line(X), the number of MLCD sets in vertical line(Y)

The top 4bits - X (Max: 15), the bottom 4bits - Y (Max: 15) / 1:1 screen ratio (Full screen) is "0x11"

\* S: The ID of MLCD to be expanded in top left position, 1:1 screen ratio (Full screen) is "0x00"

\* X: The number of all X axis line, 1:1 screen ratio (Full screen) is "0x01"  
 \* Make all LCD do the same operation, But, there will be no return communication, (One way command)  
 Broadcast command: e.g.) In case of 5x5 MLCD formation

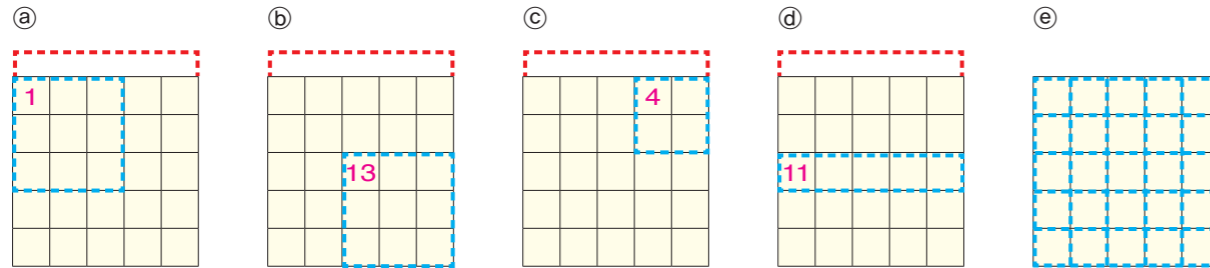

a	0x02(STX)	0xDD(CMD)	0x04(Length)	0x00(ID)	0x33(XY)	0x01(S)	0x05(X)	0x03(ETX)
b	0x02(STX)	0xDD(CMD)	0x04(Length)	0x00(ID)	0x33(XY)	0x0D(S)	0x05(X)	0x03(ETX)
c	0x02(STX)	0xDD(CMD)	0x04(Length)	0x00(ID)	0x22(XY)	0x04(S)	0x05(X)	0x03(ETX)
d	0x02(STX)	0xDD(CMD)	0x04(Length)	0x00(ID)	0x41(XY)	0x0B(S)	0x05(X)	0x03(ETX)
e	0x02(STX)	0xDD(CMD)	0x04(Length)	0x00(ID)	0x11(XY)	0x00(S)	0x01(X)	0x03(ETX)

– Receive from MLCD

Value	STX	CMD	Length	Data		Check Sum	ETX
				ID	Master		
Value	0x02	Variable	0x02	Variable	0x01	Variable	0x03

\* ID range (Program): 0x01(1) ~ 0xFF(255)  
 \* Check Sum: execute "Not" operation after adding all the values in "STX~Data" area.

### 3.4. Infomation

- Command for displaying the information on the screen (Input source and resolution by OSD)
- It is available only on Power On (Operative) status.
- CMD: 0x42
- Send to MLCD

A. Normal command

Value	STX	CMD	Length	Data		ETX
				ID	Master	
Value	0x02	0x42	0x02	Variable	0x01	0x03

\* ID range(Program): 0x01(1) ~ 0xFF(255)

B. Broadcast command

Value	STX	CMD	Length	Data: ID	ETX
Value	0x02	0x42	0x01	0x00	0x03

\* All LCD will do the same operation simultaneously, But, there will be no return communication, (One way command)

– Receive from MLCD

Value	STX	CMD	Length	Data		Check Sum	ETX
				ID	Master		
Value	0x02	0x40	0x02	Variable	0x01	Variable	0x03

\* ID range (Program): 0x01(1) ~ 0xFF(255)  
 \* Check Sum: execute "Not" operation after adding all the values in "STX~Data" area.

### 3.5. Input-Mode Change

- Command for changing input mode without screen scaling
- It is available only on Power On (Operative) status.
- CMD: 0xDD(DVI), 0xDE(PC), 0xE2(Video)

– Send to MLCD

A. Normal Command

Value	STX	CMD	Length	Data		ETX
				ID	Master	
Value	0x02	Variable	0x02	Variable	0x01	0x03

\* ID range(Program): 0x01(1) ~ 0xFF(255)

B. Broadcast Command

Value	STX	CMD	Length	Data: ID	ETX
Value	0x02	Variable	0x01	0x00	0x03

\* Make all LCD (Master/Slave) do the same operation. But, there will be no return communication, (One way command)

– Receive from MLCD

Value	STX	CMD	Length	Data		Check Sum	ETX
				ID	Master		
Value	0x02	Variable	0x02	Variable	0x01	Variable	0x03

\* ID range (Program): 0x01(1) ~ 0xFF(255)

\* Check Sum: execute "Not" operation after adding all the values in "STX~Data" area.

### 3.6. Global Offset

- Command for removing the image data in seam area (On) or displaying all the data on the screen (Off)
- It is available only on Power On (Operative) status.
- CMD: 0x74(On), 0x73(Off)

– Send to MLCD

A. Normal Command

Value	STX	CMD	Length	Data		ETX
				ID	Master	
Value	0x02	Variable	0x02	Variable	0x01	0x03

\* ID range(Program): 0x01(1) ~ 0xFF(255)

B. Broadcast Command

Value	STX	CMD	Length	Data: ID	ETX
Value	0x02	Variable	0x01	0x00	0x03

\* Make all LCD (Master/Slave) do the same operation. But, there will be no return communication, (One way command)

– Receive from MLCD

Value	STX	CMD	Length	Data		Check Sum	ETX
				ID	Master		
Value	0x02	Variable	0x02	Variable	0x01	Variable	0x03

\* ID range (Program): 0x01(1) ~ 0xFF(255)

\* Check Sum: execute "Not" operation after adding all the values in "STX~Data" area.

### 3.7. Auto-Power Mode

- Configuration for automatic power on by AC power connection.
- It is available only on Power On (Operative) status.
- CMD: 0x62(On), 0x63(Off)
- Send to MLCD

A. Normal Command

Value	STX	CMD	Length	Data		ETX
				ID	Master	
	0x02	Variable	0x02	Variable	0X01	0x03

\* ID range(Program): 0x01(1) ~ 0xFF(255)

B. Broadcast Command

Value	STX	CMD	Length	Data: ID	ETX
	0x02	Variable	0x01	0x00	0x03

\* All LCD will do the same operation simultaneously. But, there will be no return communication. (One way command)

- Receive from MLCD

Value	STX	CMD	Length	Data		Check Sum	ETX
				ID	Master		
	0x02	Variable	0x02	Variable	0X01	Variable	0x03

\* ID range (Program): 0x01(1) ~ 0xFF(255)

\* Check Sum: execute "Not" operation after adding all the values in "STX~Data" area..

### 3.8. DTV Over-Scan On/Off

- Users can select Over-scan when input is DTV resolution from DVI. It is only available with DVI mode.
- It is usable only at Power on status.
- CMD: 0xE4(On), 0xE5(Off)
- Send to MLCD

A. Normal Command

Value	STX	CMD	Length	Data		ETX
				ID	Master	
	0x02	Variable	0x02	Variable	0X01	0x03

\* ID range(Program): 0x01(1) ~ 0xFF(255)

B. Broadcast Command

Value	STX	CMD	Length	Data: ID	ETX
	0x02	Variable	0x01	0x00	0x03

\* Make all LCD do the same operation. But, there will be no return communication. (One way command)

- Receive from MLCD

Value	STX	CMD	Length	Data		Check Sum	ETX
				ID	Master		
	0x02	Variable	0x02	Variable	0X01	Variable	0x03

\* ID range (Program): 0x01(1) ~ 0xFF(255)

\* Check Sum: Execute "Not" operation after adding all the values in "STX~Data" area.

### 3.9. Over-Temperature Shut-down Control

- Commands for automatic power off making MLCD set stand-by and OSD warning method, if IP board temperature is 95°C or higher.
- It is available only on Power On (Operative) status.
- The initial configuration is "Over Temperature Shut-down Enable."
- CMD

\* 0x64(Over Temperature Shut-down Enable)

: In case IP board temperature is 95°C or higher, display warning signal "High Temperature" in red for 1 minute at the lower left corner of MLCD and power off automatically (Stand-by mode.)

\* 0x65(Over Temperature Shut-down Disable)

: In case IP board temperature is 95°C or higher, display warning signal "High Temperature" in red for 3 seconds at the lower left corner of MLCD and repeat the warning every 60 seconds. (No automatic power off)

- Send to MLCD

A. Normal Command

Value	STX	CMD	Length	Data		ETX
				ID	Master	
	0x02	Variable	0x02	Variable	0x01	0x03

\* ID range(Program): 0x01(1) ~ 0xFF(255)

B. Broadcast Command

Value	STX	CMD	Length	Data: ID	ETX
	0x02	Variable	0x01	0x00	0x03

\* Make all LCD do the same operation. But, there will be no return communication. (One way command)

- Receive from MLCD

Value	STX	CMD	Length	Data		Check Sum	ETX
				ID	Master		
	0x02	Variable	0x02	Variable	0x01	Variable	0x03

\* ID range(Program): 0x01(1) ~ 0xFF(255)

\* Check Sum: Add the sum from STX to Data and execute "Not" operation.

### 3.10. Test Pattern

- Command for checking the operating status with internal patterns
- It is available only on Power On (Operative) status.
- CMD: 0x57 (Red), 0x58 (Green), 0x59 (Blue), 0x5A (White), 0x5B (Screen)
- Send to MLCD

A. Normal Command

Value	STX	CMD	Length	Data		ETX
				ID	Master	
	0x02	Variable	0x02	Variable	0X01	0x03

\* ID range(Program): 0x01(1) ~ 0xFF(255)

B. Broadcast Command

Value	STX	CMD	Length	Data: ID	ETX
	0x02	Variable	0x01	0x00	0x03

\* Make all LCD do the same operation. But, there will be no return communication. (One way command)

– Receive from MLCD

Value	STX	CMD	Length	Data		Check Sum	ETX
				ID	Master		
Value	0x02	Variable	0x02	Variable	0X01	Variable	0x03

\* ID range (Program): 0x01(1) ~ 0xFF(255)

\* Check Sum: execute "Not" operation after adding all the values in "STX~Data" area.

### 3.11. FAN Mode

- Command for FAN control
- It is available only on Power On (Operative) status.
- CMD: 0xD8
- Send to MLCD

A. Normal Command

Value	STX	CMD	Length	Data			ETX
				ID	Master	Control	
Value	0x02	0xD8	0x02	Variable	0x01	Variable	0x03

\* ID range(Program): 0x01(1) ~ 0xFF(255)

\* Control : Auto(0x00), Full(0x01)

B. Broadcast Command

Value	STX	CMD	Length	Data		ETX
				ID	Control	
Value	0x02	0xD8	0x02	0x00	Variable	0x03

\* But, there will be no return communication. (One way command)

– Receive from MLCD

Value	STX	CMD	Length	Data		Check Sum	ETX
				ID	Master		
Value	0x02	0xD8	0x02	Variable	0x01	Variable	0x03

\* ID range (Program): 0x01(1) ~ 0xFF(255)

\* Check Sum: execute "Not" operation after adding all the values in "STX~Data" area.

### 3.12. Elapsed Time

- Command for informing the elapsed time of each LCD set. (Basic unit: hour)
- It is available only on Power On (Operative) status.
- CMD : 0x77 (Get), 0x7B (Initial)
- Send to MLCD

Value	STX	CMD	Length	Data		ETX
				ID	Master	
Value	0x02	Variable	0x02	Variable	0X01	0x03

\* ID range (Program): 0x01(1) ~ 0xFF(255)

\* It is not applicable as "Broad-cast" command

– Receive from MLCD

Value	STX	CMD	Length	Data			Check Sum	ETX
				ID	Master	Elapsed Time		
Value	0x02	Variable	0x08	Variable	0X01	...	Variable	0x03

Hundred thousands	ten thousands	thousands	hundreds	ten	one
Variable	Variable	Variable	Variable	Variable	Variable

\* ID range(Program): 0x01(1) ~ 0xFF(255)

\* Check Sum: Execute "Not" operation after adding all the values in "STX~Data" area.

\* Elapsed Time

– Hundred thousands, ten thousands, thousands, hundreds, tens, ones: 0(0x00)~9(0x09) range value.

### 3.13. IP Serial Number

- Command for assigning and identifying the serial numbers of each IP board. (8 digit)
- CMD: 0x75 (Get S/N), 0x76 (Set S/N)
- Send to MLCD

Value	STX	CMD	Length	Data		ETX
				ID	Master	
Value	0x02	Variable	0x02	Variable	0X01	0x03

\* ID range (Program): 0x01(1) ~ 0xFF(255)

\* "Get/Set IP Serial Number"(0x75/0x76) command is not applicable as "Broad-cast" command, because each LCD should have an unique serial number.

– Receive from MLCD

Value	STX	CMD	Length	Data			Check Sum	ETX
				ID	Master	SN		
Value	0x02	Variable	0x0A	Variable	0x01	...	Variable	0x03

0	1st	2nd	3rd	4th	5th	6th	7th
Variable	Variable	Variable	Variable	Variable	Variable	Variable	Variable

\* ID range(Program): 0x01(1) ~ 0xFF(255)

\* Check Sum: Execute "Not" operation after adding all the values in "STX~Data" area.

\* Elapsed Time

– 0, 1st, 2nd, 3rd, 4th, 5th, 6th, 7th: 0(0x00)~9(0x09) range value

### 3.14. Get Current Status

- Command for obtain the current LCD (IP) information
- It is available only on Power On (Operative) status.
- CMD: 0x87
- Send to MLCD

Value	STX	CMD	Length	Data		ETX
				ID	Master	
Value	0x02	0x87	0x02	Variable	0X01	0x03

\* ID range (Program): 0x01(1) ~ 0xFF(255)

\* It cannot be used as "Broad-cast" command.

– Receive from MLCD

Value	STX	CMD	Length	Data			Check Sum	ETX
				ID	Master	Status		
Value	0x02	0x87	0x23	Variable	0X01	...	Variable	0x03

\* ID range(Program): 0x01(1) ~ 0xFF(255)

\* Check Sum: Execute "Not" operation after adding all the values in "STX~Data" area.

\* Status (32 byte)

No.	Data	Length	Explanation
1	PWR Status	1 byte	0: Power Off (Stand-by), 1: Power On (Working)
2	Input Source	1 byte	0x0C: PC, 0x0B: DVI, 0x0D: DTV, 0x07: DVD, 0x05: S-Video, 0x02: Video
3	Resolution	1 byte	The value of "Displayed Resolution at the time of detection"
4	Not Used		
5	Global Offset	1 byte	0: Global Offset Off, 1: Global Offset On
6	Color Temp.	1 byte	0: Normal mode, 1: Studio mode
7	Auto-Power Mode	1 byte	0: Auto-Power Off, 1: Auto-Power On
8	FAN Mode	1 byte	0 : Auto, 1: Full
9	Temperature0	1 byte	0(0x00): 0°C~ 127(0x7F): 127°C / 128(0x80): -1°C ~ 254(0xFE): -127°C 0xFF: Temp. Sensor Error
10	Temperature1	1 byte	0(0x00): 0°C ~ 127(0x7F): 127°C / 128(0x80): -1°C ~ 254(0xFE): -127°C 0xFF: Temp. Sensor Error
11	FAN Status	1 byte	0x30: Good, 0x31: Error, 0x32: Don't Care
12-18	F/W Version	7 byte	Year: 2 byte, Month: 2byte, Day: 2byte, Rev.(0~9):1byte Ex) December 29th, 2012 Rev. 2 → 0x01 0x02 0x01 0x02 0x02 0x09 0x02
19	Not Used		
20-27	S/N	8 byte	123456 → 0x00 0x00 0x01 0x02 0x03 0x04 0x05 0x06 1 → 0x00 0x00 0x00 0x00 0x00 0x00 0x00 0x01
28-33	Elapsed Time	6 byte	54321 → 0x00 0x05 0x04 0x03 0x02 0x01 10 → 0x00 0x00 0x00 0x00 0x01 0x00

< Displayed Resolution at the time of detection (It is different from the supporting Resolution) >

Resolution	Value	Resolution	Value	Resolution	Value
640x480x60	0(0x00)	720Px50	29(0x1D)	1360x768x60	25(0x19)
<b>640x480x85</b>	<b>1(0x01)</b>	576Px50	30(0x1E)	<b>640x350x85</b>	<b>46(0x2E)</b>
<b>800x600x56</b>	<b>2(0x02)</b>	480Px60	31(0x1F)	<b>640x480x75</b>	<b>47(0x2F)</b>
800x600x60	3(0x03)	1920x1080ix60	32(0x20)	<b>640x480x72</b>	<b>48(0x30)</b>
<b>800x600x75</b>	<b>4(0x04)</b>	1920x1080ix50	33(0x21)	<b>1152x864x75</b>	<b>49(0x31)</b>
<b>800x600x85</b>	<b>5(0x05)</b>	1280x720Px60	34(0x22)	1280x720x60	50(0x32)
853x480x60	6(0x06)	1280x720Px50	35(0x23)	<b>1280x768x75</b>	<b>51(0x33)</b>
1024x768x60	7(0x07)	PAL	36(0x24)	<b>1280x1024x75</b>	<b>52(0x34)</b>
<b>1024x768x70</b>	<b>8(0x08)</b>	SECAM	37(0x25)	1366x768x50	53(0x35)
<b>1024x768x75</b>	<b>9(0x09)</b>	PALP	38(0x26)	1400x1050x50	54(0x36)
<b>1024x768x85</b>	<b>10(0x0A)</b>	NTSC	39(0x27)	1440x900x60	55(0x37)
1280x768x60	11(0x0B)	NTSCP	40(0x28)	576ix50	56(0x38)
1280x960x60	12(0x0C)	Unknown	42(0x2A)	480ix60	57(0x39)
1280x1024x60	13(0x0D)	No-Signal	43(0x2B)	1080px60	58(0x3A)
1366x768x60	14(0x0E)	853x480x50	18(0x12)	1080px50	59(0x3B)
1600x1200x60	15(0x0F)	1280x1024x50	19(0x13)	1920x1080px60	60(0x3C)
1400x1050x60	16(0x10)	1360x768x50	20(0x14)	1920x1080px50	61(0x3D)
1706x960x60	17(0x11)	1600x900x50	21(0x15)	1024x576x50	62(0x3E)
1080ix60	26(0x1A)	1600x900x60	22(0x16)	1024x576x60	63(0x3F)
1080ix50	27(0x1B)	1600x1200x50	23(0x17)		
720Px60	28(0x1C)	800x600x50	24(0x18)		

※ The resolutions written in red or italic letters can be detected, but they are not supporting resolutions.

3.15. Graphic User Mode Control

- Command for controlling Brightness, Contrast, Sharpness
- It is available only on Power On (Operative) status.
- The adjusted value is not applied during Stand-by or No-signal status.
- CMD: 0x8A (Brightness), 0x8B (Contrast), 0x8C (Sharpness)
- Send to MLCD

A. Normal Command

Value	STX	CMD	Length	Data			ETX
				ID	Master	Control	
Value	0x02	Variable	0x03	Variable	0X01	Variable	0x03

\* ID range(Program): 0x01(1) ~ 0xFF(255)

\* Control: Brightness ("0" ~ "100"), Contrast ("0" ~ "100"), Sharpness ("0" ~ "28")

B. Broadcast Command

Value	STX	CMD	Length	Data		ETX
				ID	Value	
Value	0x02	Variable	0x02	0x00	Variable	0x03

\* Make all LCD do the same operation. But, there will be no return communication. (One way command)

\* Control: Brightness ("0" ~ "100"), Contrast ("0" ~ "100"), Sharpness ("0" ~ "28")

– Receive from MLCD

Value	STX	CMD	Length	Data		Check Sum	ETX
				ID	Master		
Value	0x02	Variable	0x02	Variable	0X01	Variable	0x03

\* ID range (Program): 0x01(1) ~ 0xFF(255)

\* Check Sum: Execute "Not" operation after adding all the values in "STX~Data" area.

3.16. Color Temperature

- Normal Mode is 9300, Studio mode is 3600 (Default: Normal Mode).
- Normal mode is applicable for general purpose and Studio mode is designed for broadcasting purpose.
- It is available only on Power On (Operative) status.
- CMD: 0xB3 (Normal), 0xB4 (Studio: broadcasting purpose)
- Send to MLCD

A. Normal Command

Value	STX	CMD	Length	Data		ETX
				ID	Master	
Value	0x02	Variable	0x02	Variable	0X01	0x03

\* ID range(Program): 0x01(1) ~ 0xFF(255)

B. Broadcast Command

Value	STX	CMD	Length	Data: ID	ETX
Value	0x02	Variable	0x01	0X00	0x03

\* Make all LCD do the same operation. But, there will be no return communication. (One way command)

– Receive from MLCD

	STX	CMD	Length	Data		Check Sum	ETX
				ID	Master		
Value	0x02	Variable	0x02	Variable	0X01	Variable	0x03

\* ID range (Program): 0x01(1) ~ 0xFF(255)

\* Check Sum: execute "Not" operation after adding all the values in "STX~Data" area.

### 3.17. Tracking Mode

- A command for adjusting alignment manually or automatically or loading the predetermined values at PC RGB mode only.
- CMD: 0x4A (Auto-tracking), 0x4B (Get Tracking Values), 0x4C (Frequency-tracking), 0x4D (Phase-tracking), 0x4E (Line-Start tracking), 0x4F (Pixel-Start tracking)
- It is available only on Power On (Operative) status.
- Send to MLCD

A. Normal Command

	STX	CMD	Length	Data		ETX
				ID	Master	
Value	0x02	Variable	0x02	Variable	0X01	0x03

B. Broad-Cast Command

	STX	CMD	Length	Data: ID	ETX
Value	0x02	Variable	0x01	0x00	0x03

C. Frequency/Phase/Line-Start/Pixel-Start-tracking (Normal Command): Adjusting PC (RGB) screen manually.

	STX	CMD	Length	Data			ETX
				ID	Master	Tracking Value	
Value	0x02	Variable	0x03	Variable	0X01	Variable	0x03

D. Frequency/Phase/Line-Start/Pixel-Start-tracking (Broad-Cast Command): Adjusting PC (RGB) screen manually.

	STX	CMD Value	Length	Data		ETX
				ID	Tracking Value	
Value	0x02	Variable	0x02	0x00	Variable	0x03

\* ID range (Program): 0x01(1) ~ 0xFF(255)

\* Broad-cast: All LCD sets will execute the same command, when the ID is 0x00. No response (One way command)

\* "Get Tracking Value" command cannot be used for "Broad-cast" command.

- Frequency value range: 77(0x4D) ~ 177(0xB1) / Real Value(-50 ~ +50) / Real Value + 127(0x7F)
- Phase value range: 127(0x7F) ~ 190(0xBE) / Real Value(0 ~ +63) / Real Value + 127(0x7F)
- Line Start value range: 104(0x68) ~ 137(0x89) / Real Value(-23 ~ +10) / Real Value + 127(0x7F)
- Pixel Start value range: 77(0x4D) ~ 167(0xA7) / Real Value(-50 ~ +40) / Real Value + 127(0x7F)

- Receive from MLCD

A. Auto-tracking, Frequency/Phase/Line-Start/Pixel-Start-tracking

	STX	CMD	Length	Data		Check Sum	ETX
				ID	Master		
Value	0x02	Variable	0x02	Variable	0X01	Variable	0x03

B. Get Tracking Values

	STX	CMD	Length	Data			Check Sum	ETX
				ID	Master	Tracking Value		
Value	0x02	Variable	0x06	Variable	0X01	...	Variable	0x03

Frequency	Phase	LineStart	PixelStart
-----------	-------	-----------	------------

Variable	Variable	Variable	Variable
----------	----------	----------	----------

\* ID range(Program): 0x01(1) ~ 0xFF(255)

\* Tracking Value

- Frequency value range : 77(0x4D) ~ 177(0xB1) / Real Value(-50 ~ +50) / Real Value + 127(0x7F)
- Phase value range : 127(0x7F) ~ 190(0xBE) / Real Value(0 ~ +63) / Real Value + 127(0x7F)
- Line Start value range : 104(0x68) ~ 137(0x89) / Real Value(-23 ~ +10) / Real Value + 127(0x7F)
- Pixel Start value range : 77(0x4D) ~ 167(0xA7) / Real Value(-50 ~ +40) / Real Value + 127(0x7F)

\* Check Sum: execute "Not" operation after adding all the values in "STX~Data" area.

### 3.18. White Balance Control

- Command for adjusting Gain R/G/B and Offset R/G/B for White balance
- The adjusted value is not applied during Stand-by or No-signal status. MLCD must be operating status and there must be the input signal of each mode.
- To apply the same configuration to all MLCD sets, the "ID" area value can be set as "0x00." However, considering differences between sets, individual adjustment for white balance is recommended.
- CMD: 0xAC (Gain R), 0xAD (Gain G), 0xAE (Gain B), 0xB0 (Offset R), 0xB1 (Offset G), 0xB2 (Offset B)

- Send to MLCD

A. Normal Command

	STX	CMD	Length	Data			ETX
				ID	Master	Control	
Value	0x02	Variable	0x03	Variable	0x01	Variable	0x03

\* ID range(Program): 0x01(1) ~ 0xFF(255)

\* Control: "0 (0x00)" ~ "255 (0xFF)"

- Receive from MLCD

	STX	CMD	Length	Data		Check Sum	ETX
				ID	Master		
Value	0x02	Variable	0x02	Variable	0x01	Variable	0x03

\* ID range (Program): 0x01(1) ~ 0xFF(255)

\* Check Sum: Execute "Not" operation after adding all the values in "STX~Data" area.

### 3.19. Firmware Default Set (Picture Control Data)

- Initialize the LCD set. All the settings will be returned to the initial condition prior to the adjustment in the factory. Pre-programmed value will be applied.
- It is available only on Power On (Operative) status.
- Since previous Picture Control Data will be lost with this command. High caution is required.
- Send to MLCD

	STX	CMD	Length	Data		ETX
				ID	Master	
Value	0x02	0x81	0x02	Variable	0x01	0x03

\* ID range(Program): 0x01(1) ~ 0xFF(255)

\* It is not applicable as "Broad-cast" command.

- Receive from MLCD

	STX	CMD	Length	Data		Check Sum	ETX
				ID	Master		
Value	0x02	0x81	0x02	Variable	0x01	Variable	0x03

\* ID range(Program): 0x01(1) ~ 0xFF(255)

\* Check Sum: Execute "Not" operation after adding all the values in "STX~Data" area.

### 3.20. Get Picture Control Data

- Command for acquiring the current Picture Control Data(User Mode, White Balance, Graphic, Video)
- It is available only on Power On (Operative) status.
- The values based on current Color Temp. (Normal Mode / Studio Mode) will be displayed.
- CMD: 0x88
- Send to MLCD

Value	STX	CMD	Length	Data		ETX
				ID	Master	
	0x02	0x88	0x02	Variable	0x01	0x03

\* ID range(Program): 0x01(1) ~ 0xFF(255)  
 \* It is not applicable as "Broad-cast" command.

- Receive from MLCD

Value	STX	CMD	Length	Data			Check Sum	ETX
				ID	Master	Control		
	0x02	0x88	0x36	Variable	0x01	...	Variable	0x03

\* ID range(Program): 0x01(1) ~ 0xFF(255)  
 \* Control (52 byte)

No.	Data	Length	Explanation
1	User Mode - Brightness	1 byte	Range: 0(0x00) ~ 100(0x64)
2	User Mode - Contrast	1 byte	Range: 0(0x00) ~ 100(0x64)
3	User Mode - Sharpness	1 byte	Range: 0(0x00) ~ 28(0x1C)
4	Not Used		
5	Not Used		
6	White Balance - Gain R	1 byte	Range: 0(0x00) ~ 255(0xFF)
7	White Balance - Gain G	1 byte	Range: 0(0x00) ~ 255(0xFF)
8	White Balance - Gain B	1 byte	Range: 0(0x00) ~ 255(0xFF)
9	White Balance - Offset R	1 byte	Range: 0(0x00) ~ 255(0xFF)
10	White Balance - Offset G	1 byte	Range: 0(0x00) ~ 255(0xFF)
11	White Balance - Offset B	1 byte	Range: 0(0x00) ~ 255(0xFF)
12, 13	RGB - Gain R	2byte	Range : 0(0x000) ~ 1023(0X3FF)
14, 15	RGB - Gain G	2byte	Range : 0(0x000) ~ 1023(0X3FF)
16, 17	RGB - Gain B	2byte	Range : 0(0x000) ~ 1023(0X3FF)
18, 19	RGB - Offset R	2byte	Range : 0(0x000) ~ 1023(0X3FF)
20, 21	RGB - Offset G	2byte	Range : 0(0x000) ~ 1023(0X3FF)
22, 23	RGB - Offset B	2byte	Range : 0(0x000) ~ 1023(0X3FF)
24 ~ 47	Not Used	24byte	
48	Video Brightness	1byte	Range : 0(0x00) ~ 255(0xFF)
49	Video Contrast	1byte	Range : 0(0x00) ~ 255(0xFF)
50	Video Color	1byte	Range : 0(0x00) ~ 255(0xFF)
51	Dimming	1byte	Range : 0(0x00) ~ 100(0x64)
52	Gamma	1byte	Range : 1(0x01) ~ 6(0x06)

### 3.21. Auto Calibration

- Command for synchronizing the ADC Gain and Offset for 16-Gray input. It is available only for PC.
- It is available only on Power On (Operative) status.

- CMD : 0x80
- Send to MLCD
  - A. Normal Command

Value	STX	CMD	Length	Data		ETX
				ID	Master	
	0x02	0x80	0x02	Variable	0x01	0x03

- B. Broadcast Command

Value	STX	CMD	Length	Data: ID	ETX
	0x02	0x80	0x01	0x00	0x03

\* ID range (Program): 0x01(1) ~ 0xFF(255)  
 \* Broadcast: All LCD sets will execute the same command, when the ID is 0x00. No response (One way command)

- Receive From MLCD

Value	STX	CMD	Length	Data		Check Sum	ETX
				ID	Master		
	0x02	0x80	0x02	Variable	0x01	Variable	0x03

### 3.22. Dimming Control

- Command for adjusting the Back-Light Brightness.
- CMD : 0xDC
- Send to MLCD
  - A. Normal command

Value	STX	CMD	Length	Data			ETX
				ID	Master	Control	
	0x02	0xDC	0x03	Variable	0x01	Variable	0x03

\* ID Range(Program) : 0x01(1) ~ 0xFF(255)  
 \* Control : 0x00(0) ~ 0x64(100)

- B. Broadcast command

Value	STX	CMD	Length	Data		ETX
				ID	Control	
	0x02	0xDC	0x02	0x00	Variable	0x03

\* Make all LCD do the same operation. But, there will be no return communication.(One way command)

- Receive From MLCD

Value	STX	CMD	Length	Data		Check Sum	ETX
				ID	Master		
	0x02	0xDC	0x02	Variable	0x01	Variable	0x03

\* Check Sum : execute "Not" operation after adding all the values in "STX~Data" area.

### 3.23. Gamma Control

- Command for adjusting the Gamma.
- CMD : 0x89

– Send to MLCD

A. Normal command

Value	STX	CMD	Length	Data			ETX
				ID	Master	Control	
Value	0x02	0x89	0x03	Variable	0x01	Variable	0x03

\* ID Range(Program) : 0x01(1) ~ 0xFF(255)

\* Control : 0x01(1) ~ 0x06(6)

– 1 : No Gamma, 2 : Gamma 1.5, 3: Gamma 1.9, 4 : Gamma 2.0, 5: Gamma 2.2, 6 : Gamma 2.5

B. Broadcast command

Value	STX	CMD	Length	Data		ETX
				ID	Control	
Value	0x02	0x89	0x02	0x00	Variable	0x03

\* Make all LCD do the same operation, But, there will be no return communication,(One way command)

– Receive From MLCD

Value	STX	CMD	Length	Data		Check Sum	ETX
				ID	Master		
Value	0x02	0x89	0x02	Variable	0x01	Variable	0x03

\* Check Sum : execute "Not" operation after adding all the values in "STX~Data" area.

### 3.24. Factory Data (Picture Control Data)

– Command for loading the Picture Control data (User Mode / White Balance / RGB Data / VIDEO Data) adjusted in the factory.

– It is usable only at Power on Operative

– It shows the value based on current Color Temp. (Normal Mode / Studio Mode.)

– Data can be checked with "Get Picture Control Data" after executing the command

– CMD : 0x82(Save), 0x83(Load)

– Send to MLCD

Value	STX	CMD	Length	Data		ETX
				ID	Master	
Value	0x02	Variable	0x02	Variable	0x01	0x03

\* ID range(Program): 0x01(1) ~ 0xFF(255)

– Receive from MLCD

Value	STX	CMD	Length	Data		Check Sum	ETX
				ID	Master		
Value	0x02	Variable	0x02	Variable	0x01	Variable	0x03

\* ID range(Program): 0x01(1) ~ 0xFF(255)

\* Check Sum: Execute "Not" operation after adding all the values in "STX~Data" area.

### 3.25. Get Temperature Status

– Command for acquiring temperature information.

– It is usable only at Power on status.

– Send to MLCD

Value	STX	CMD	Length	Data		ETX
				ID	Master	
Value	0x02	0x7F	0x02	Variable	0x01	0x03

\* ID range(Program): 0x01(1) ~ 0xFF(255)

\* It is not applicable as "Broad-cast" command.

– Receive from MLCD

Value	STX	CMD	Length	Data			Check Sum	ETX
				ID	Master	Temperature Values		
Value	0x02	0xF7	0x04	Variable	0x01	...	Variable	0x03

Temp.0	Temp.1
Variable	Variable

\* Temperature Values (Temp.0, Temp.1)

– 0(0x00): 0°C ~ 127(0x7F): 127°C

– 128(0x80): -1°C ~ 254(0xFE): -127°C

– 0xFF: Temp. Sensor Error

\* Check Sum: Execute "Not" operation after adding all the values in "STX~Data" area.

### ※ Attachment : ASCII to HEX Conversion Table

ASCII	HEX	ASCII	HEX	ASCII	HEX	ASCII	HEX	ASCII	HEX	ASCII	HEX	ASCII	HEX
STX	02	*	2A	9	39	H	48	W	57	f	66	u	75
ETX	03	+	2B	:	3A	I	49	X	58	g	67	v	76
Esc	1B	,	2C	;	3B	J	4A	Y	59	h	68	w	77
CR	0D	-	2D	<	3C	K	4B	Z	5A	i	69	x	78
LF	0A	.	2E	=	3D	L	4C	[	5B	j	6A	y	79
Space	20	/	2F	>	3E	M	4D	\	5C	k	6B	z	7A
!	21	0	30	?	3F	N	4E	]	5D	l	6C	{	7B
"	22	1	31	@	40	O	4F	^	5E	m	6D		7C
#	23	2	32	A	41	P	50	-	5F	n	6E	}	7D
\$	24	3	33	B	42	Q	51	`	60	o	6F	~	7E
%	25	4	34	C	43	R	52	a	61	p	70	DEL	7F
&	26	5	35	D	44	S	53	b	62	q	71		
'	27	6	36	E	45	T	54	c	63	r	72		
(	28	7	37	F	46	U	55	d	64	s	73		
)	29	8	38	G	47	V	56	e	65	t	74		



## 8. Before calling for service

- Before calling for any repair, check the following and then refer to a near A/S center.

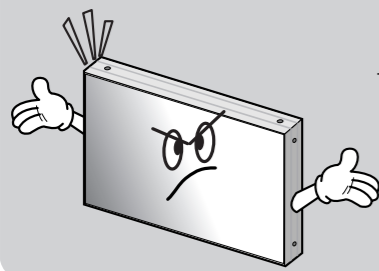

► "Tick" sound from the main body.

- If there is no problem with the screen or sound, the "tick" sound is likely to result from the cabinet lightly shrinking with the change of room temperature. The sound does not affect product's performance.

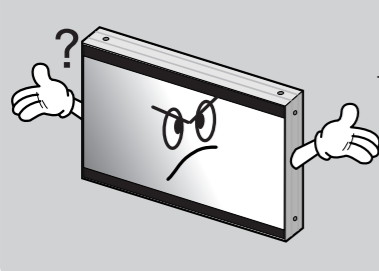

► No image at upper and lower part of the screen.

- As for a screen which is over 16:9 in width (such as cinema-sized one), no image may be displayed at upper and bottom part of the screen.

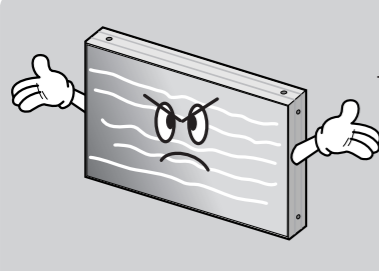

► Speckles or white lines on the screen

- Check whether the problem is caused by vehicle, streetcar, high-voltage cable or neon sign, which emitting interference wave or electromagnetic induction. Avoid any interfering object.

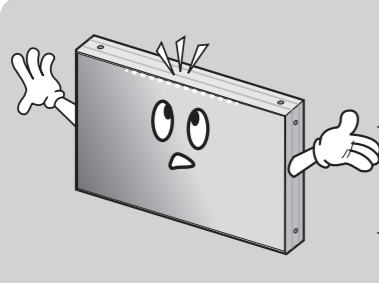

► Light leakage can be found at the edge areas around the screen.

- If the light leakage is not detected at 1m from the screen, the panel is considered as no defect.(SAMSUNG LCD applies the same inspection standard)
- To minimize the light leakage, the MLCD sets should be installed with high accuracy in horizontal and vertical position.

## 9. Applicable signals (DVI, PC)

- DTV signal(EDTV, HDTV) is not supported in PC Input.

Resolution	V-Freq (Hz)	H-Freq (KHz)	Pixel Clock (MHz)	Horizontal (Pixels)				Vertical (Lines)				Pol. (H/V)	Standard Type
				Total	Addr. Width	Sync. Width	Back Porch	Total	Addr. Width	Sync. Width	Back Porch		
640*480*60	60	31.469	25.175	800	640	96	40	525	480	2	25	-/-	DMT
800*600*50	50	30.998	30.750	992	800	72	96	621	600	4	14	+/+	CVT
800*600*60	60	37.879	40.000	1056	800	128	88	628	600	4	23	+/+	DMT
1024*768*60	60	48.363	65.000	1344	1024	136	160	806	768	6	29	-/+	DMT
1280*768*60	60	47.776	79.500	1664	1280	128	192	798	768	7	20	-/+	CVT
1280*960*60	60	60.000	108.000	1800	1280	112	312	1000	960	3	36	+/+	CVT
1280*1024*50	50	52.679	88.500	1680	1280	128	200	1057	1024	7	23	+/+	CVT
1280*1024*60	60	63.981	108.000	1688	1280	112	248	1066	1024	3	38	+/+	DMT
1360*768*50	50	39.564	69.000	1744	1360	136	192	793	768	5	17	+/+	CVT
1360*768*60	60	47.712	85.5000	1792	1360	112	256	795	768	6	18	+/+	DMT
1366*768*60	60	50.000	80.000	1600	1366	128	64	838	768	5	22	-/+	ORION(46")
1400*1050*60	60	65.317	121.750	1864	1400	144	232	1089	1050	4	32	-/+	CVT
1600*900*50	50	46.394	96.500	2080	1600	160	240	929	900	5	21	-/+	CVT
1600*900*60	60	55.990	118.250	2112	1600	168	256	934	900	5	26	-/+	CVT
1600*1200*50	50	61.795	131.500	2128	1600	168	264	1238	1200	4	31	+/+	CVT
1600*1200*60	60	75.000	162.000	2160	1600	192	304	1250	1200	3	46	+/+	DMT
480p	60	31.469	27.000	858	720	62	62	525	480	6	30	+/+	EDTV
576p	50	31.250	27.000	864	720	64	68	625	576	5	39	+/+	EDTV
720p50	50	37.500	74.250	1980	1280	80	220	750	720	5	20	+/+	HDTV
750p60	60	45.000	74.250	1650	1280	80	220	750	720	5	20	+/+	HDTV
1080i50	50	28.125	74.250	2640	1920	88	148	1125	1080	10	30	+/+	HDTV
1080i60	60	33.750	74.250	2200	1920	88	148	1120	1080	10	25	+/+	HDTV
1080p50	50	56.250	148.500	2640	1920	88	148	1125	1080	5	36	-/-	HDTV
1080p60	60	67.500	148.500	2200	1920	88	148	1125	1080	5	36	-/-	HDTV

## 10. Specification

Model Name		OLM-4610	OLM-4650	OLM-4651
Back Light Type		CCFL	CCFL	LED
Power Supply		AC100V ~ 240V (50/60Hz)		
Power Consumption	Max	200W	285W	150W
	Typical	190W	260W	145W
	Stand-By	3.0W	4.5W	3.0W
Luminance of White		450 cd / m <sup>2</sup>	700 cd / m <sup>2</sup>	
Contrast ratio (Dark Room)		4,500 : 1	3,000 : 1	3,500 : 1
Seam Gap (Multi Configuration)		7.3mm		5.9mm
Active Display Area (H X V)		1018.353 X 572.544mm		1018.08 X 572.67mm
Aspect Ratio		16 : 9		
Number of pixels		1366 (H) X 768 (V)		1920 (H) X 1080 (V)
Pixel Pitch		0.7455 X 0.7455 mm		0.53025 X 0.53025 mm
Display Colors		16.7M		
Viewing Angle		H : 178°, V : 178°		
Response Time (G to G)		8msec (TYP.)		
Environmental condition	Temperature	5°C ~ 35°C		
	Humidity	35% ~ 75%		
Input Signal	PC / DVI Signal (HDCP Available)	VGA, SVGA, XGA, SXGA, UXGA, WXGA, 480p,576p,720p(50/60),1080i(50/60),1080p(50/60)		
	HDCP	Support	Not Support	Support
	Video Signal	NTSC, PAL, SECAM		
	Frequency	H : 31.5 ~ 75kHz, V : 50 , 60 Hz		
In/Output Terminal	Input	DVI-D x 1, PC x 1, Video x 1, RS-232C x 1, LAN x1, Service x 1		
	Output	DVI-D x 1, PC x 1, Video x 1, RS-232C x 1		
Lamp Life Tme		Min 50.000Hrs (Ta : 25±2°C)		
Dimension (W X H X D)		1025.9 x 580 x 99.8mm		1023.98 x 578.57 x 98.8mm

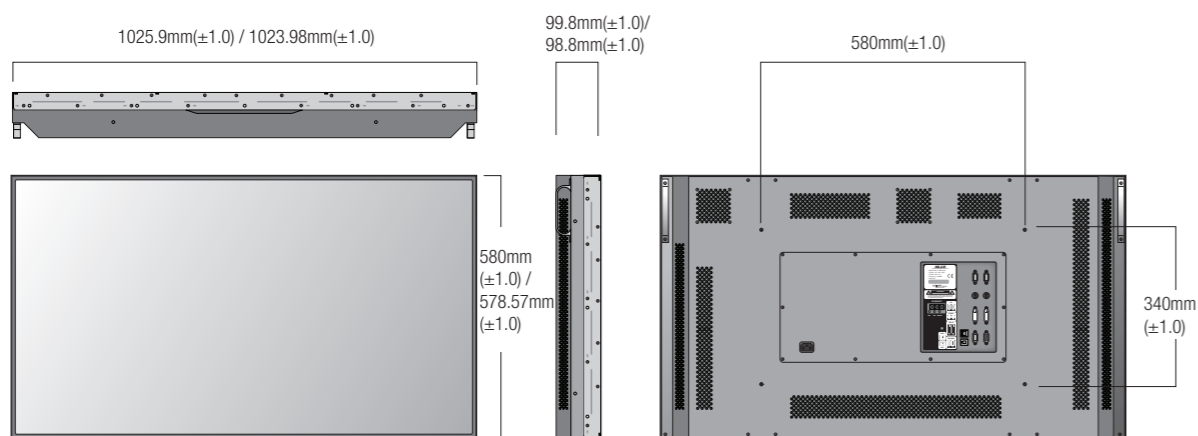

Weights	24Kg(±0.5Kg)	27Kg(±0.5Kg)	25Kg(±0.5Kg)
---------	--------------	--------------	--------------

※Product design and specification can be changed for quality improvement without prior notice.

Model Name		OLM-5510	OLM-5550
Back Light Type		LED	
Power Supply		AC100V ~ 240V (50/60Hz)	
Power Consumption	Max	171W	235W
	Typical	163W	205W
	Stand-By	3.0W	
Luminance of White		450 cd / m <sup>2</sup>	700 cd / m <sup>2</sup>
Contrast ratio (Dark Room)		3,500 : 1	
Seam Gap (Multi Configuration)		5.9mm	5.7mm
Active Display Area		1209.6(H) X 680.4(V) mm	
Aspect Ratio		16 : 9	
Number of pixels		1920 (H) X 1080 (V)	
Pixel Pitch		0.63 (H) X 0.63 (V)mm	
Display Colors		16.7M	
Viewing Angle		H : 178°, V : 178°	
Response Time (G to G)		8msec (TYP.)	
Environmental condition	Temperature	5°C ~ 35°C	
	Humidity	35% ~ 75%	
Input Signal	PC / DVI Signal (HDCP Available)	VGA, SVGA, XGA, SXGA, UXGA, WXGA, 480p,576p,720p(50/60),1080i(50/60),1080p(50/60)	
	Video Signal	NTSC, PAL, SECAM	
	Frequency	H : 31.5 ~ 75kHz, V : 50 , 60 Hz	
In/Output Terminal	Input	DVI-D x 1, PC x 1, Video x 1, RS-232C x 1, LAN x1, Service x 1	
	Output	DVI-D x 1, PC x 1, Video x 1, RS-232C x 1	
Lamp Life Tme		Min 50.000Hrs (Ta : 25±2°C)	
Dimension (W X H X D)		1215.9 x 686.7 x 99.6mm	1215.7 x 686.5 x 98.7mm

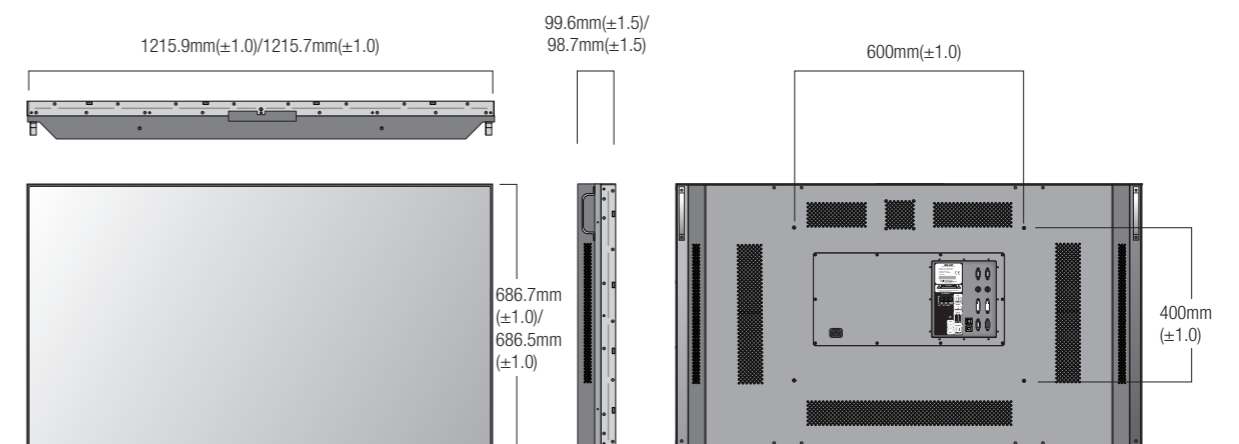

Weights	31.2Kg(±0.5Kg)	31Kg(±0.5Kg)
---------	----------------	--------------

※Product design and specification can be changed for quality improvement without prior notice.

## 11. Option Specification

### 11.1. DVI Converter

Product Name	Specification	
DVI Converter (ODC-10000)	Power supply	100 ~ 250V AC, 50/60Hz
	Power consumption	40W (MAX)
	Size	405mm(W) X 250mm(D) X 60mm(H)
	Environmental Condition	0°C ~ 40°C, 20 ~80% RH
	Weight	3Kg

#### Input/Output Specification

	Terminal Name	Terminal Specification	
Video Input Singal	Composite Video	BNC 1Pin	NTSC, PAL, SECAM
	S-Video	DIN 4Pin	NTSC, PAL, SECAM
	Component Video	BNC 3Pin	480i, 576i, 480p, 576p, 720p, 1080i, 1080p
	Analog RGB	D-Sub 15Pin	VGA, SVGA, WVGA, XGA, SXGA, WXGA, UXGA Horizontal Freq. : 15.5Khz ~ 75Khz Vertical Freq. : 50/60Hz
	DVI / HDMI	DVI-D 24Pin /HDMI 29Pin	480p, 576p, 720p, 1080i, 1080p VGA, SVGA, WVGA, XGA, SXGA, WXGA, UXGA Horizontal Freq. : 15.5Khz ~ 75Khz Vertical Freq. : 50/60Hz
	SDI	BNC 1Pin	SMPTE 259M-C, SMPTE 292M, SMPTE 424M, SMPTE 425 (Level A & B)
Video Output Signal	DVI	DVI-D 24Pin	640X480-60/85, 800X600-50/60/85, 853X480-50/60, 1027X768-60/85, 1280X1024-50/60, 1600X900-50/60, 1600X1200-50/60, 1706X960-60
Control Method	RS-232C	D-Sub 9Pin (Female)	Baud Rate : 115200 Max ±15V
	Ethernet	RJ-45	TCP/IP
	Key Pad		Input Souce Select Hot Key, Output Resolution Select Hot Key, Navigation Key(OSD), Control Channel Select, Communication Method Select.
Display	C-LCD	2X16	Input Souce, Output Resolution Display

※ Specification can be changed without prior notice to improve product quality.

※ Ethernet communication is available when it is used with New MFC.

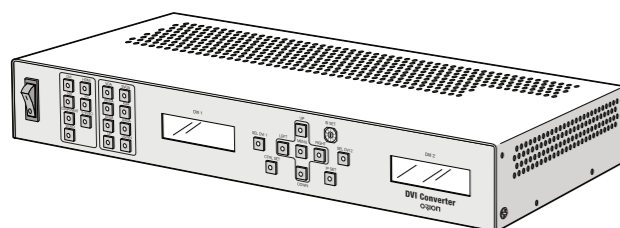

### 11.2. New MFC

Product Name	Specification	
Remote Controller	Name	MLCD REMOTE CONTROL
	Power	1.5V Battery(AAA) 2EA
	Size	55(W) x 190(L) x 25(H) mm
	Environmental Condition	-10°C ~ 40°C
	Weight	130g
NEW MFC	Voltage	+5~9V(DC), 1.25W (MAX)
	Power Consumption	250mA(Max, +5~9V)
	Size	58(W) x 216(L) x 46(H) mm
	Environmental Condition	0°C ~ 40°C, 20 ~80% RH
Adapter	Weight	480g
	Size	35(W) x 80(L) x 86(H) mm
	Input	90~264V(47~63Hz)
	Output	5V, 2000mA
Output Jack	2.1 (Internal diameter):Vcc, 5.5 (External diameter):GND	

#### Input/Output Specification

NEW MFC	Terminal Name	Terminal Specification	
Control Input	RS-232C	D-Sub 9Pin (Female)	Baud Rate : 115200
	Ethernet	RJ-45	TCP/IP
	USB	Type B	USB2.0
	IR	Max 15m, left/right 45°(standard : 3m)	
	Key Button	Control Mode Select (IR / Ethernet / RS-232C / USB)	
Control Output	RS-232C (4ea)	D-Sub 9Pin (Male)	Baud Rate : 115200 Max ±15V
MLCD ID Setting	7-Segment LED	1~99	MLCD Horizontal Number, Vertical Number

- Minimum interval between button input: 0.6 second

※ Specification can be changed without prior notice to improve product quality.

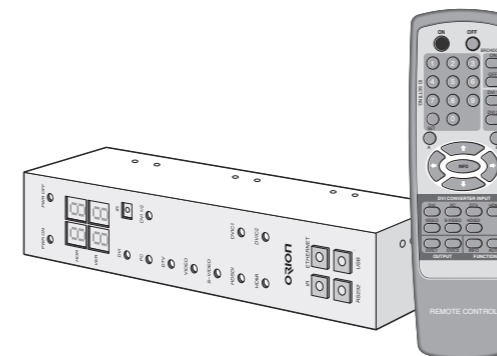

Memo

Memo